

# Think Quality!

Complete  
Dental  
Catalog

Exclusive  
2020



we take a *closer look*





# WWE



OUR GOAL is to provide quality surgical, dental and orthodontics products at Affordable prices.

Our best Operating Room quality instruments incorporating the highest grades of surgical steel, finely detailed craftsmanship and exacting standards of manufacturing.





The face of health care industry is changing and we are helping you to face the challenges of this change. Ehsan Surgical Company aim to introduce high quality Surgical, Dental and Orthodontics instruments in the world market, as to continue at its best a renovating process with a broad spectrum in order to innovate for surgeons through latest technology. A small but professional company we are constantly looking for areas of growth and continual improvement. Our philosophy is investment in technology, equipment and training of staff enabling them to achieve consistent standards of service and quality according to the customer's expectation. We are committed to satisfy our customers by carrying out systematic activities effectively and efficiently, providing them high quality products at appropriate time and competitive price.

**RRN**

**OUR QUALITY** All Surgical Instruments are made from high quality stainless steel will pass three crucial checks that verify the durability, toughness and good machining. In addition, a monitoring specialist for the last time the instruments directly before shipping. All Surgical Instruments are manufactured by medical grade stainless steel and can be sterilized by all common methods (either chemical or thermodynamic).

**1995**

# TABLE<sup>+</sup> OF CONTENT



# 01

## FORCEPS

- » Extraction Forceps
- » Root Fragment Forceps

# 41

## ELEVATORS

- » Root and Luxating Elevators

# 73

## SCALPELS

- » Scalpel Handles and Blades

# 81

## SCISSORS

- » Micro Scissors
- » Surgical Scissors
- » Ligature Scissors
- » Wire and Plate

# 111

## TWEEZERS

- » Micro Forceps
- » Titanium Forceps
- » Dressing Forceps
- » Endo Forceps
- » Tissue Forceps
- » TC Forceps
- » Membrane

# 139

## DRIVERS

- » Needle Holders

# 163

## HEMOSTATS / GRASPING FORCEPS

- » Towel Clamps
- » Sponge and Dressing Forceps
- » Hemostatic Forceps
- » Tissue Grasping Forceps

# 175

## RETRACTORS

- » Retractors
- » Mouth Gags and Tongue Depressors
- » Mouth Props

# 197

## IMPLANTOLOGY

- » Oteotomes and Chisels
- » Mallets
- » Periosteals
- » Trephines
- » Periosteals
- » Osteotomes
- » Trephines
- » Bone and Tissue Harvest Accessories
- » Measuring Instruments
- » Bone Holding Forceps

# 221

## PERIOSTEALS / CURETTES / BONE

- » Periosteal Elevators
- » Curettes
- » Bone Files
- » Tissue Nippers
- » Bone Rongeurs
- » Bone Cutting Forceps

# 247

## PERIODONTICS / ENDODONTICS / RESTORATION

- » Periodontics
- » Endodontics
- » Diagnostic
- » Curettes and Scalers
- » Amalgam
- » Composite
- » Spatulas
- » Filling
- » Dental Restoration
- » Perio Chisels & Knives
- » Perio Probes & Explorers
- » Filling
- » Curettes and Scalers
- » Rubber-Dam

# 313

## CROWN & BRIDGE

- » Crown and Bridge Instruments

# 319

## USEFUL DATA / MAINTENANCE & INDEX

- » Conversion of Units
- » Cleaning, Maintenance & Sterilization
- » Maintenance Cycle & Tips
- » Alphanumeric Codes



we take a *closer look*





we take a *closer* look

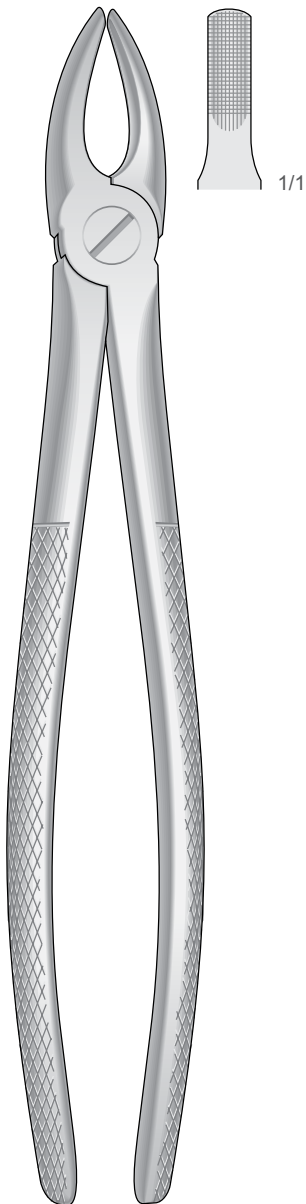
# + FORCEPS



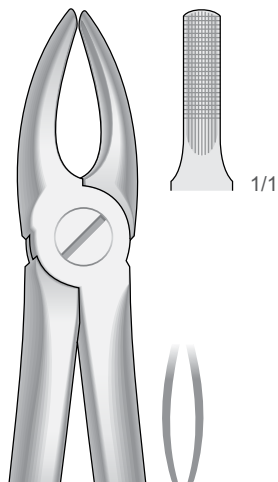
Dental Forceps  
Root Fragment Forceps



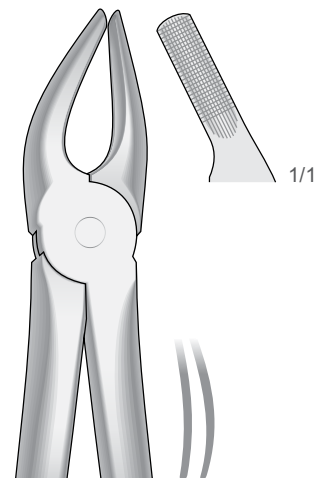
Zahnzangen, Englische Form  
 Extracting Forceps, English Pattern  
 Pinze per estrazione, Forma Inglese  
 Pinzas da extracción, Forma Inglesa  
 Daviers, Forme Anglaise



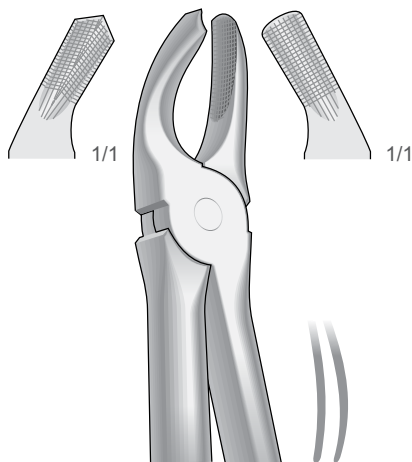
**1**  
 Fig. 1  
 Obere Schneide- und Eckzähne  
 Upper Incisors and cuspids  
 Incisivi e canini superiori  
 Incisivos y caninos superiores  
 Incisives et canines supérieures



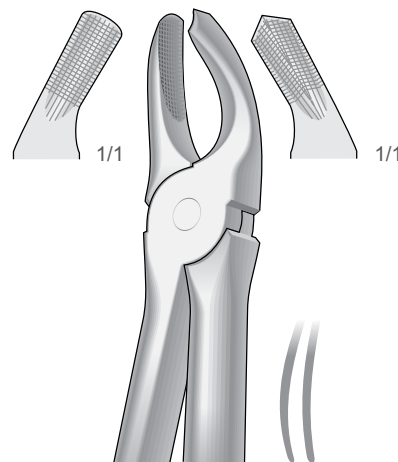
**2**  
 Fig. 2  
 Obere Schneide- und Eckzähne  
 Upper Incisors and cuspids  
 Incisivi e canini superiori  
 Incisivos y caninos superiores  
 Incisives et canines supérieures



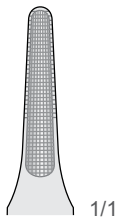
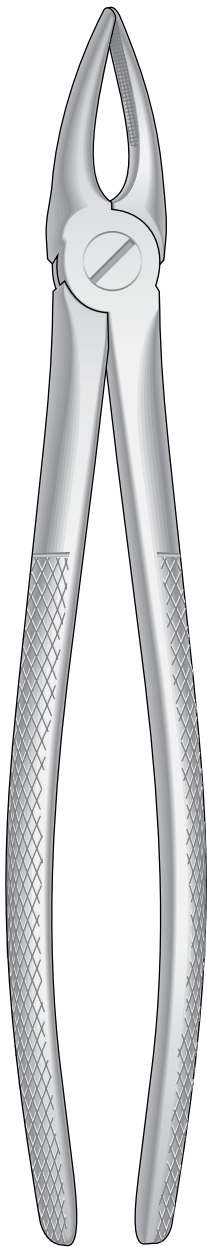
**7**  
 Fig. 7  
 Obere Prämolaren  
 Upper premolars  
 Premolari superiori  
 Premolares superiores  
 Prémolaires supérieures



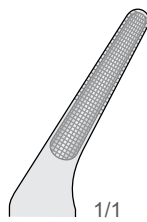
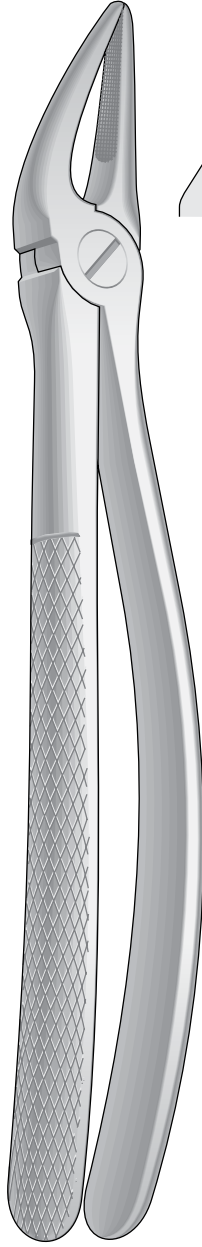
**17**  
 Fig. 17  
 Obere Molaren, rechts  
 Upper molars, right  
 Molari superiori, destra  
 Molares superiores, derechos  
 Molaires supérieures, droites



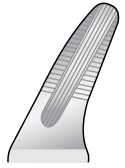
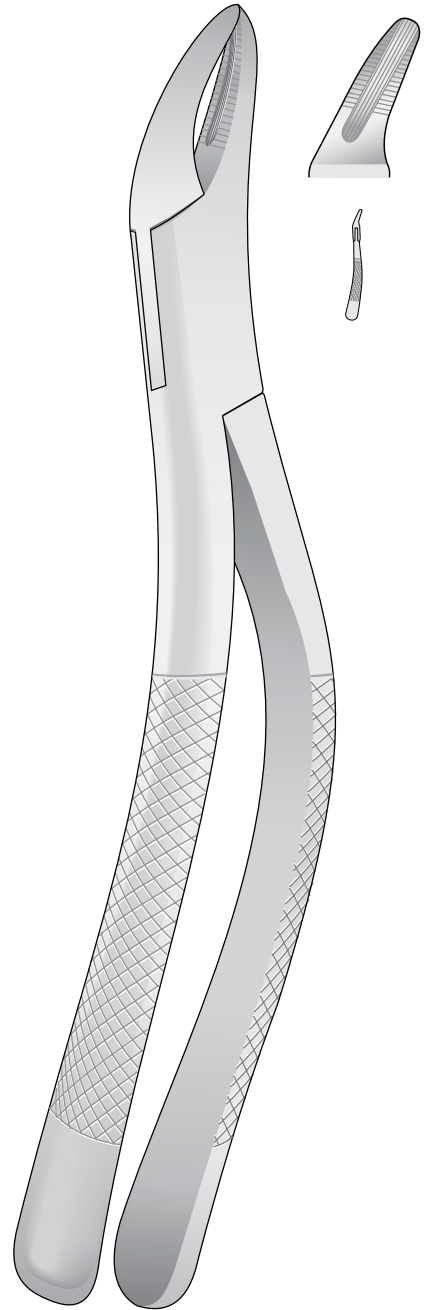
**18**  
 Fig. 18  
 Obere Molaren, links  
 Upper molars, left  
 Molari superiori, sinistra  
 Molares superiores, izquierdos  
 Molaires supérieures, gauches



1/1



1/1



**29**

Fig. 29

Obere Wurzeln und Schneidezähne  
 Upper Roots and incisors  
 Radici e incisivi superiori  
 Raíces y incisivos superiores  
 Racines et incisives supérieures

**30**

Fig. 30

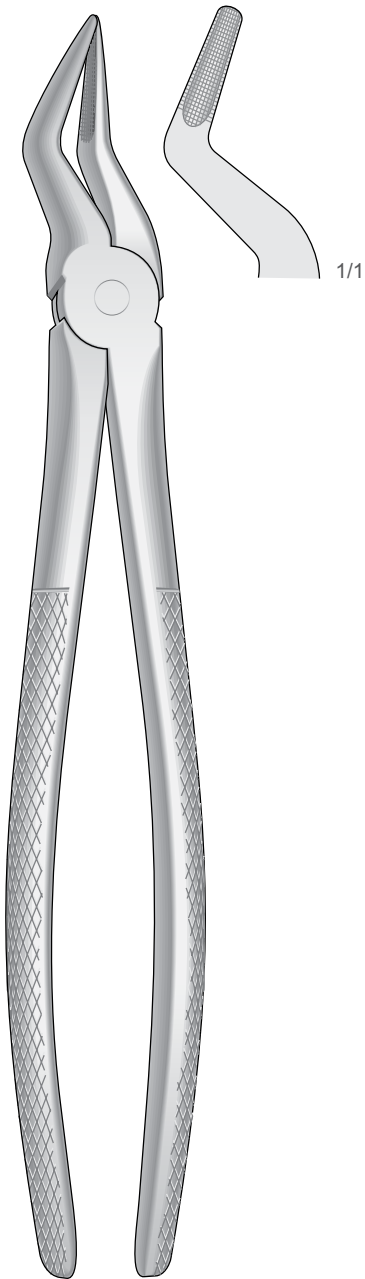
Obere Wurzeln  
 Upper Roots  
 Radici superiori  
 Raíces superiores  
 Racines supérieures

**76S**

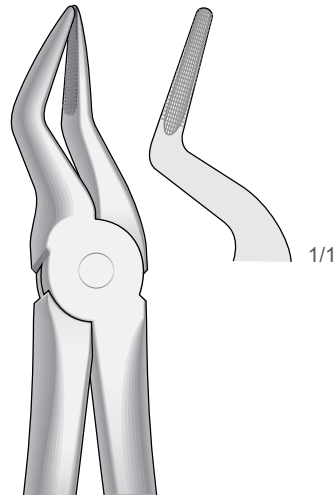
Fig. 76

Obere Schneidezähne, Prämolaren, Wurzeln  
 Upper incisors, premolars, roots  
 Incisivi, premolari e radici superiori  
 Incisivos, premolares y raíces superiores  
 Incisives, prémolaires et racines supérieures

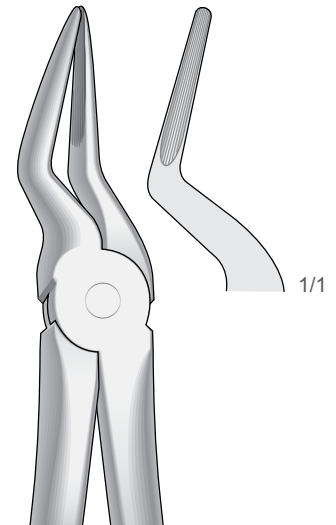
Zahnzangen, Englische Form  
 Extracting Forceps, English Pattern  
 Pinze per estrazione, Forma Inglese  
 Pinzas da extracción, Forma Inglesa  
 Daviers, Forme Anglaise



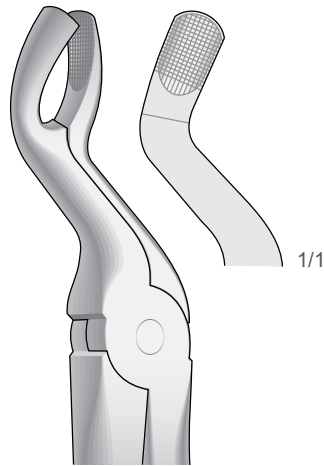
**51**  
 Fig. 51  
 Obere Wurzeln  
 Upper Roots  
 Radici superiori  
 Raíces superiores  
 Racines supérieures



**51A**  
 Fig. 51A  
 Obere Wurzeln  
 Upper Roots  
 Radici superiori  
 Raíces superiores  
 Racines supérieures

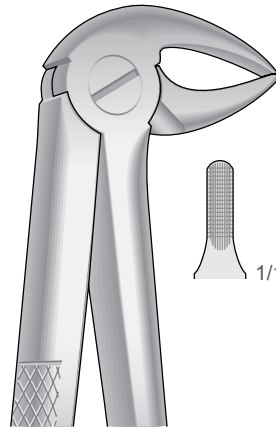


**51L**  
 Fig. 51AL  
 Obere Wurzeln  
 Upper Roots  
 Radici superiori  
 Raíces superiores  
 Racines supérieures



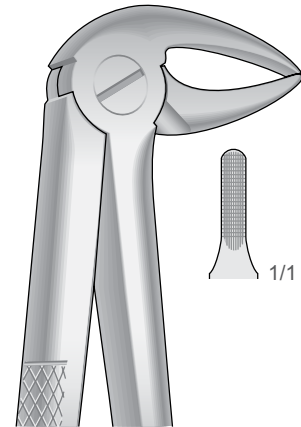
**67A**  
 Fig. 67A  
 Obere Dritte Molaren - Für Obere Weisheitszähne  
 Upper molars - For Upper wisdom teeth  
 Ottavi superiori - Per denti del giudizio superiori  
 Molares superiores - Para muelas del juicio superiores  
 Molaires supérieures - Pour dents de sagesse supérieures

Zahnzangen, Englische Form  
 Extracting Forceps, English Pattern  
 Pinze per estrazione, Forma Inglese  
 Pinzas da extracción, Forma Inglesa  
 Daviers, Forme Anglaise



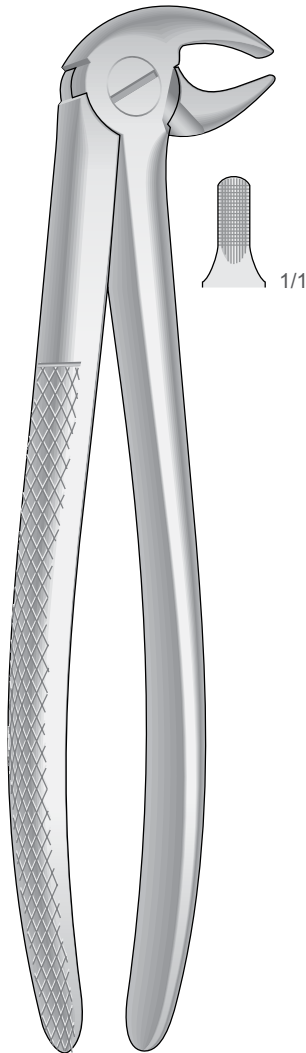
**33**  
 Fig. 33

Untere Prämolaren, Schneidezähne und Wurzeln  
 Lower incisors, premolars and roots  
 Incisivi, premolari e radici inferiori  
 Incisivos, premolares y raíces inferiores  
 Incisives, prémolaires et racines inférieures



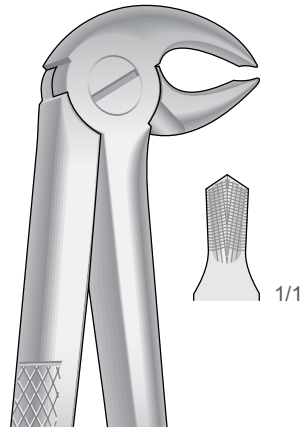
**33A**  
 Fig. 33A

Untere Wurzeln, schlankes Maul  
 Lower roots, Slender jaw  
 Radici inferiori, morso stretto  
 Raíces inferiores, boca estrecha  
 Racines inférieures, avec un bec très fin



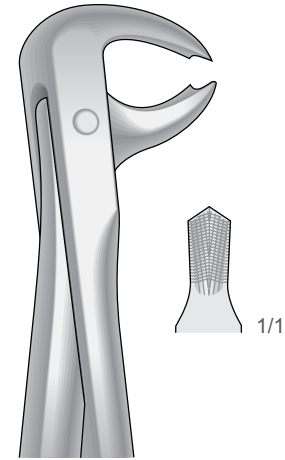
**13**  
 Fig. 13

Untere Eckzähne und Prämolaren  
 Lower cuspids and premolars  
 Canini e premolari inferiori  
 Caninos y premolares inferiores  
 Canines et prémolaires inférieures



**22**  
 Fig. 22

Untere Molaren  
 Lower molars  
 Molari inferiori  
 Molares inferiores  
 Molaires inférieures

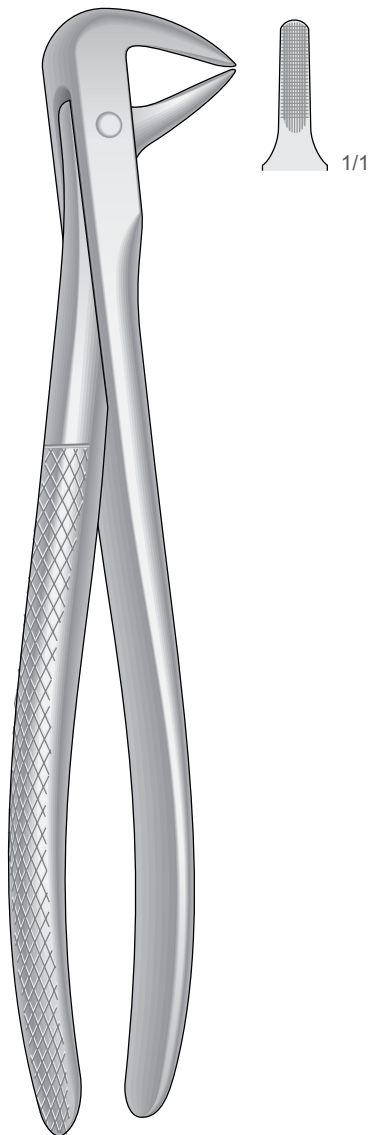


**73**  
 Fig. 73

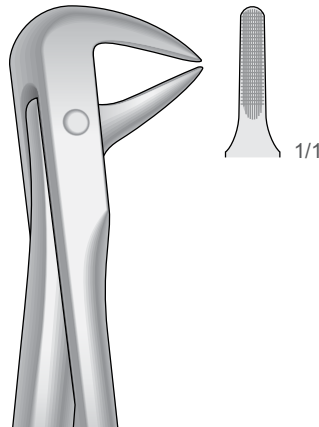
Untere Molaren  
 Lower molars  
 Molari inferiori  
 Molares inferiores  
 Molaires inférieures



Zahnzangen, Englische Form  
 Extracting Forceps, English Pattern  
 Pinze per estrazione, Forma Inglese  
 Pinzas da extracción, Forma Inglesa  
 Daviers, Forme Anglaise

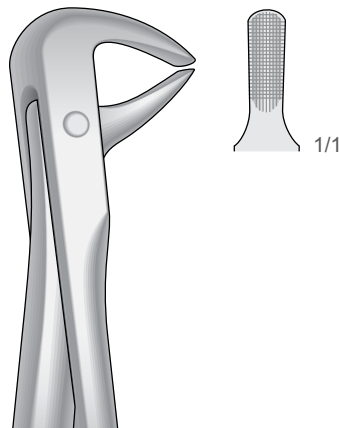


**74**  
 Fig. 74  
 Untere Wurzeln  
 Lower roots  
 Radici inferiori  
 Raíces inferiores  
 Racines inférieures



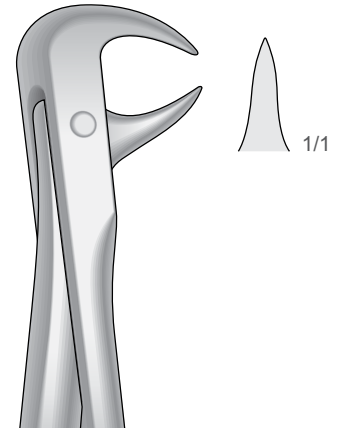
**74N**  
 Fig. 74N

Untere Wurzeln, schneide-und Eckzähne  
 Lower roots, Incisors and bicuspid  
 Radici, incisivi e canini inferiori  
 Raíces, incisivos y caninos inferiores  
 Racines, incisives et canines inférieures



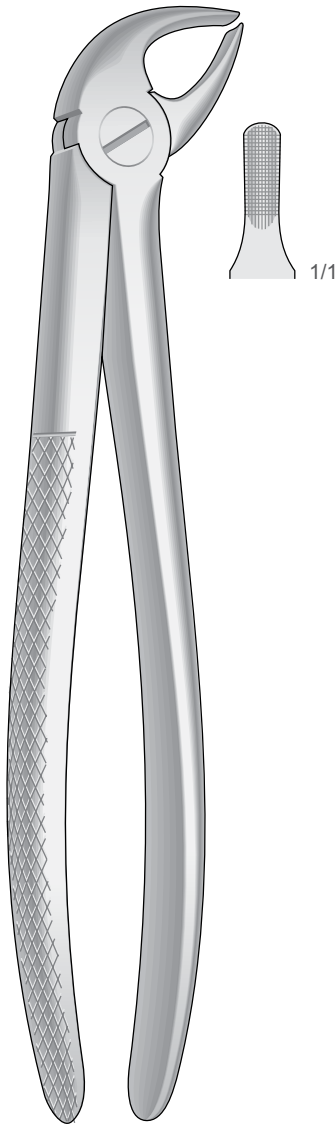
**75**  
 Fig. 75

Untere Eckzähne und Prämolaren  
 Lower Cuspids and bicuspid  
 Canini e premolari inferiori  
 Caninos y premolares inferiores  
 Canines et prémolaires inférieures



**86A**  
 Fig. 86A

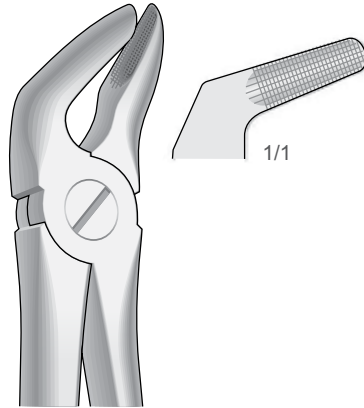
Untere Molaren  
 Lower molars  
 Molari inferiori  
 Molares inferiores  
 Molaires inférieures



**4**

Fig. 4

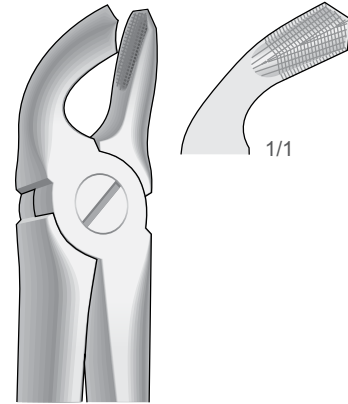
Untere Schneide- und Eckzähne  
 Lower Incisors and cuspids  
 Incisivi e canini inferiori  
 Incisivos y caninos inferiores  
 Incisives et canines inférieures



**8**

Fig. 8

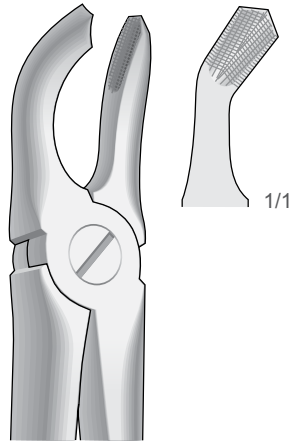
Untere Prämolaren  
 Lower premolars  
 Premolari inferiori  
 Premolares inferiores  
 Prémolaires inférieures



**21**

Fig. 21

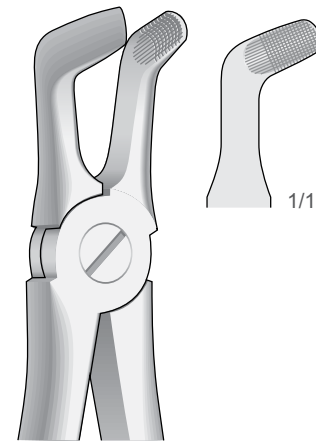
Untere Weisheitszähne und Molaren  
 Lower wisdom teeth and molars  
 Denti del giudizio e molari inferiori  
 Muelas del juicio y Molares inferiores  
 Dents de sagesse et molaires inférieures



**79**

Fig. 79

Untere Weisheitszähne  
 Lower wisdom teeth  
 Denti del giudizio inferiori  
 Muelas del juicio inferiores  
 Dent de sagesse inférieures



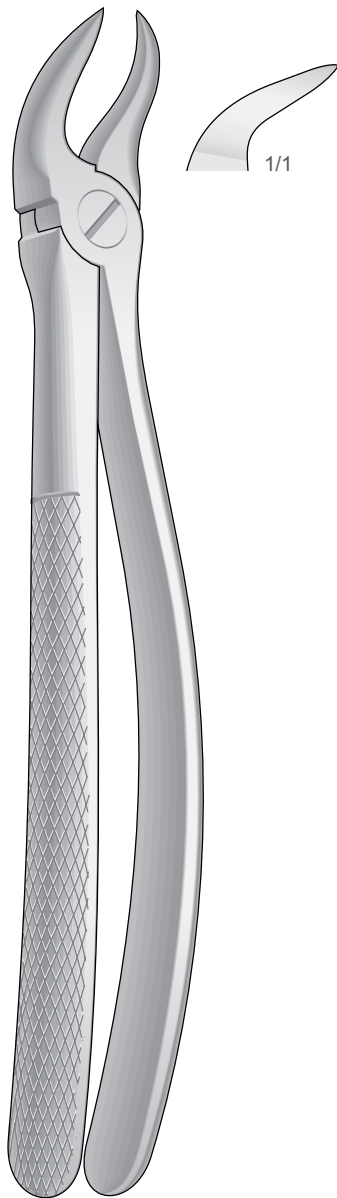
**79A**

Fig. 79A

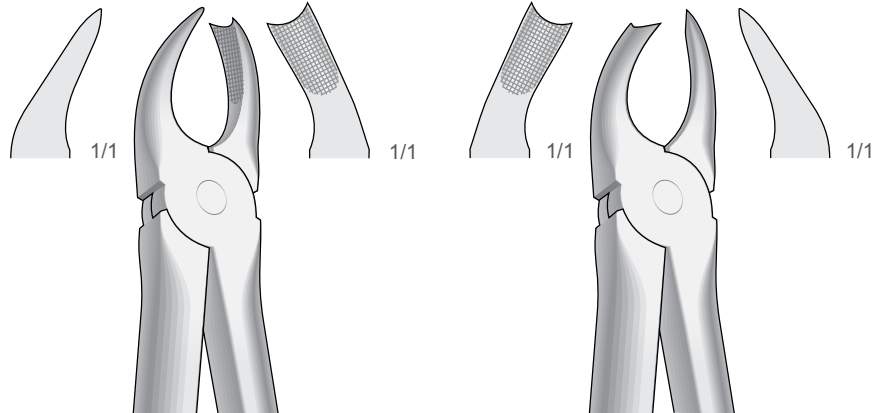
Untere Molaren und Weisheitszähne  
 Lower molars and wisdom teeth  
 Molari e denti del giudizio inferiori  
 Molares y muelas del juicio inferiores  
 Molaires et dent de sagesse inférieures



Zahnzangen, Englische Form  
 Extracting Forceps, English Pattern  
 Pinze per estrazione, Forma Inglese  
 Pinzas da extracción, Forma Inglesa  
 Daviers, Forme Anglaise

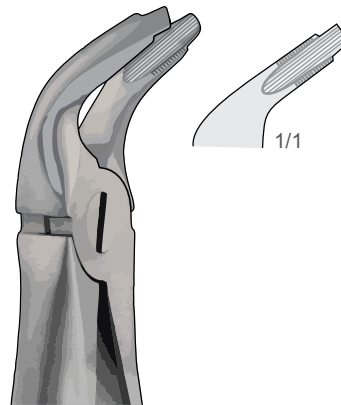


**87**  
 Fig. 87  
 Untere Molaren  
 Lower molars  
 Molari inferiori  
 Molares inferiores  
 Molaires inférieures



**89**  
 Fig. 89  
 Obere Molaren, rechts  
 Upper molars, right  
 Molari superiori, destra  
 Molares superiores, derechos  
 Molaires supérieures, droites

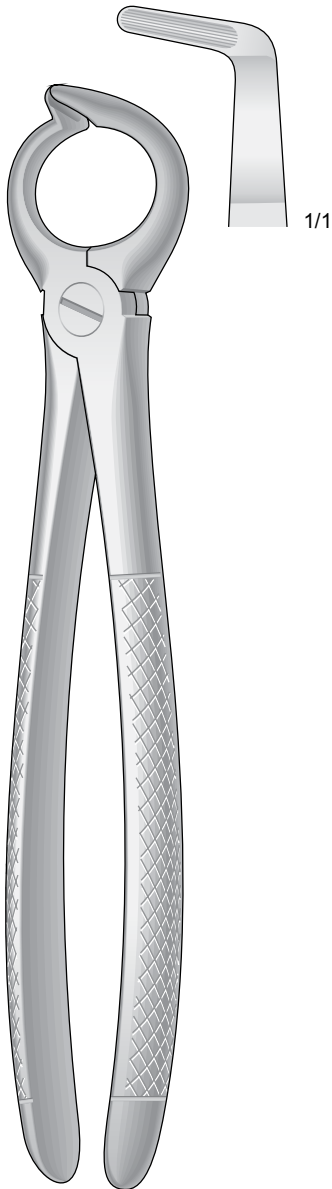
**90**  
 Fig. 90  
 Obere Molaren, links  
 Upper molars, left  
 Molari superiori, sinistra  
 Molares superiores, izquierdos  
 Molaires supérieures, gauches



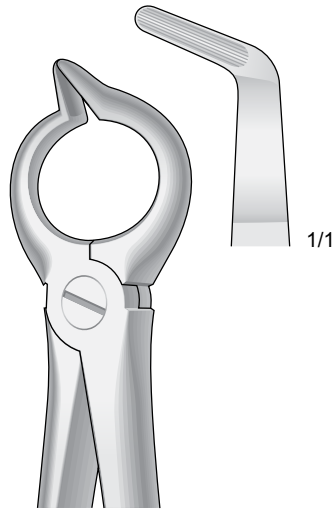
**AM-451**  
 Fig. 451  
 Deep Grip

Untere Wurzeln, schneide-und Eckzähne  
 Lower roots, incisors and bicusps  
 Radici, incisivi e canini inferiori  
 Raíces, incisivos y caninos inferiores  
 Racines, incisives et canines inférieures

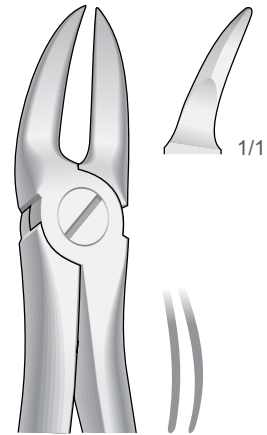
Zahnzangen, Englische Form  
 Extracting Forceps, English Pattern  
 Pinze per estrazione, Forma Inglese  
 Pinzas de extracción, Forma Inglesa  
 Daviers, Forme Anglaise



**68**  
 Fig. 68  
 Untere Wurzeln  
 Lower Roots  
 Radici inferiori  
 Raíces inferiores  
 Racines inférieures

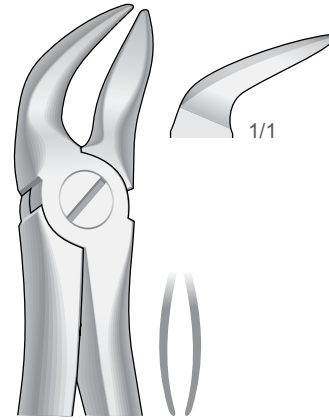


**68A**  
 Fig. 68A  
 Untere Wurzeln  
 Lower Roots  
 Radici inferiori  
 Raíces inferiores  
 Racines inférieures



**55**  
 Fig. 55

Zum Trennen oberer Molarenwurzeln  
 For separating upper molar roots  
 Per radici dei molari superiori, presa in profondità  
 Para partir raíces de molares superiores, profundo  
 Pour séparer les racines des molaires supérieures

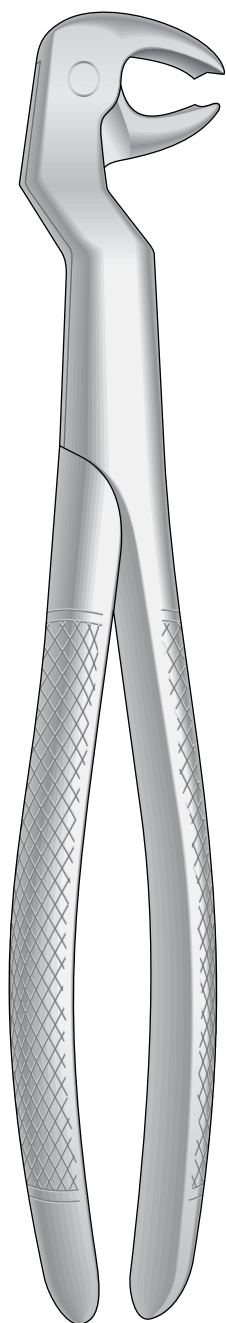


**56**  
 Fig. 56

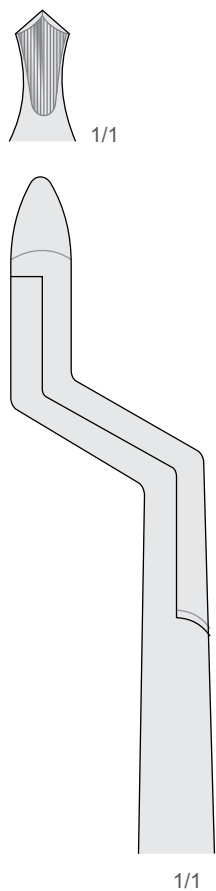
Zum Trennen Unterer Molarenwurzeln  
 For separating lower molar roots  
 Per radici dei molari inferiori, presa in profondità  
 Para partir raíces de molares inferiores, profundo  
 Pour séparer les racines des molaires inférieures



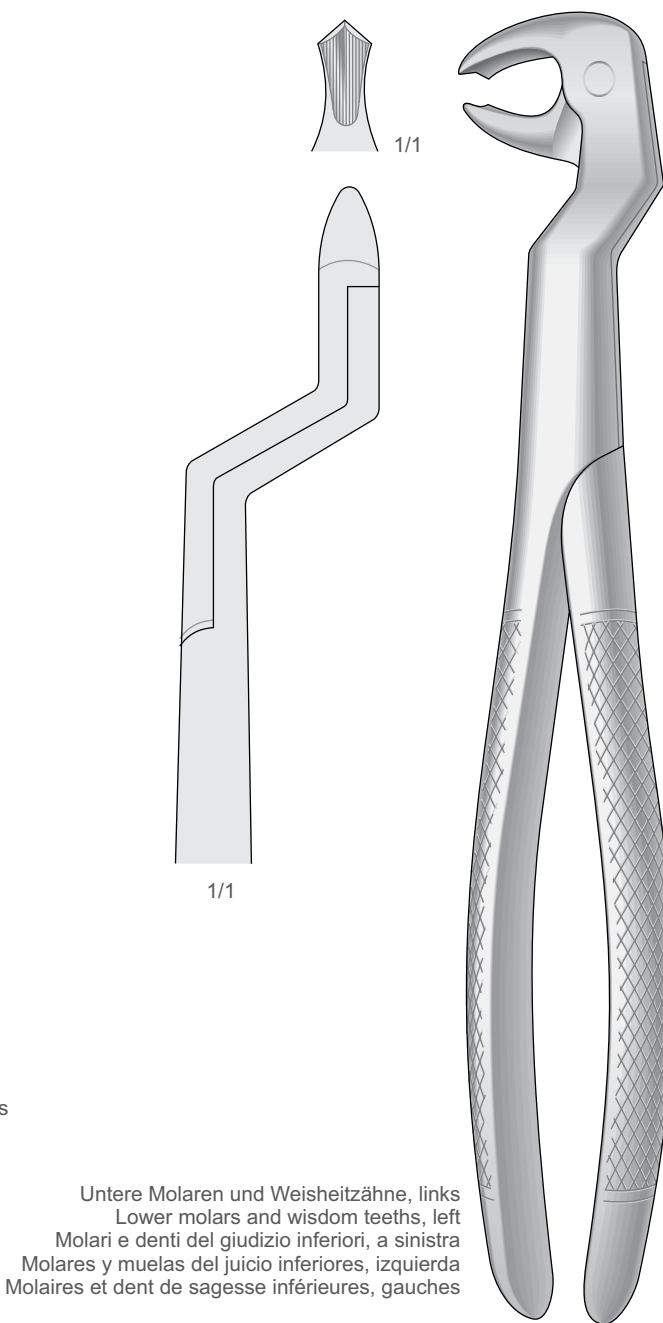
Zahnzangen, Englische Form  
 Extracting Forceps, English Pattern  
 Pinze per estrazione, Forma Inglese  
 Pinzas da extracción, Forma Inglesa  
 Daviers, Forme Anglaise



ROUTURIER  
 22 1/2 R



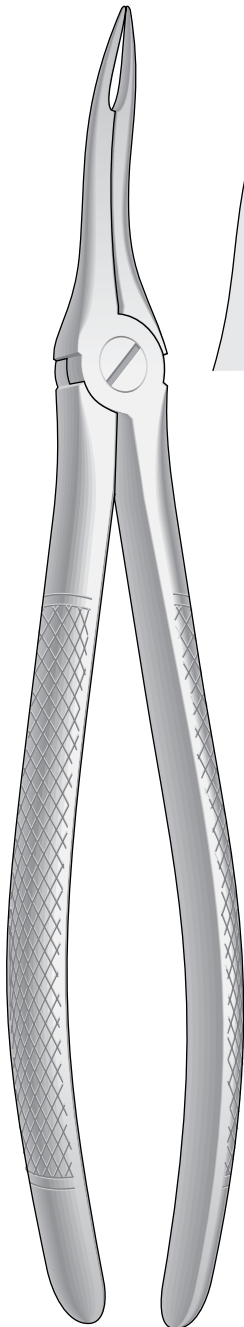
Untere Molaren und Weisheitszähne, rechts  
 Lower molars and wisdom teeth, right  
 Molari e denti del giudizio inferiori, a destra  
 Molares y muelas del juicio inferiores, derecha  
 Molaires et dent de sagesse inférieures, droites



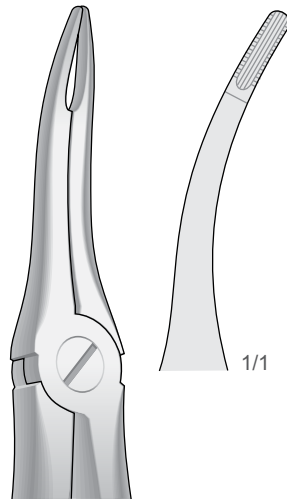
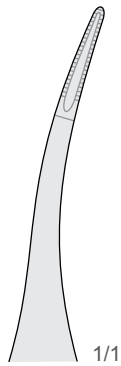
ROUTURIER  
 22 1/2 L

Untere Molaren und Weisheitszähne, links  
 Lower molars and wisdom teeth, left  
 Molari e denti del giudizio inferiori, a sinistra  
 Molares y muelas del juicio inferiores, izquierda  
 Molaires et dent de sagesse inférieures, gauches





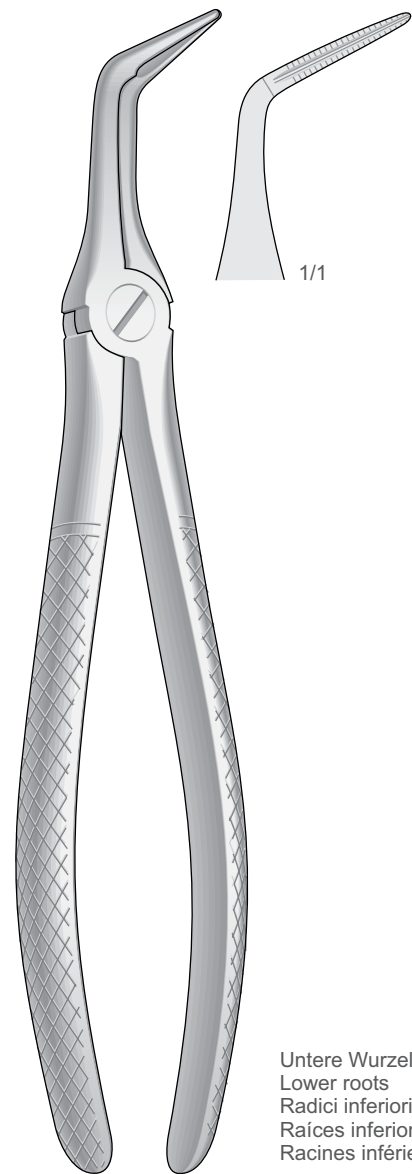
**49**  
 Fig. 49



**48**  
 Fig. 48 - 44

Obere Wurzeln  
 Upper roots  
 Radici superiori  
 Raíces superiores  
 Racines supérieures

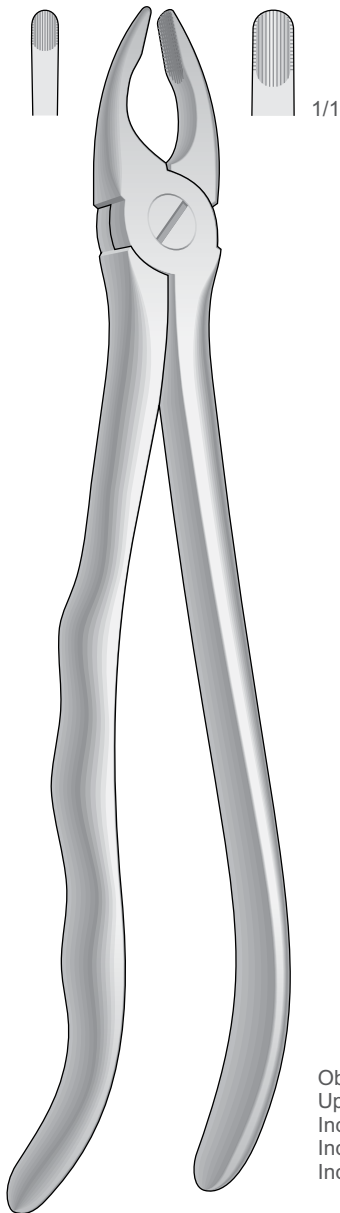
Obere Wurzeln sehr feine  
 Upper very fine roots  
 Radici superiori molto sottili  
 Raíces superiores muy finas  
 Racines supérieures très fines



**46L**  
 Fig. 46L

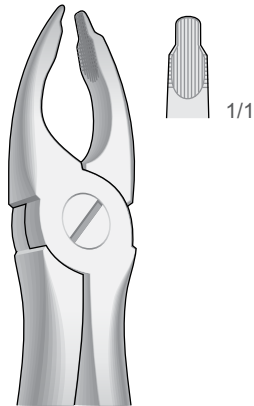
Untere Wurzeln  
 Lower roots  
 Radici inferiori  
 Raíces inferiores  
 Racines inférieures

Zahnzangen, Paßformgriff  
 Extracting Forceps, Anatomical Handle  
 Pinze per estrazione, Manico anatomico  
 Pinzas da extracción, Mango anatómico  
 Daviers, Manche anatomique



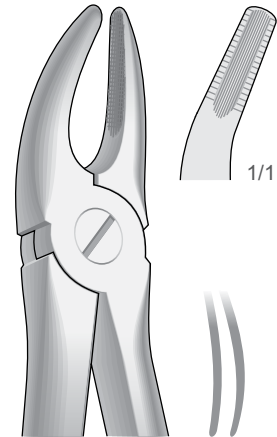
**S-3AN**  
 Fig. 3

Obere Schneide- und Eckzähne  
 Upper incisors and cuspids  
 Incisivi e canini superiori  
 Incisivos y caninos superiores  
 Incisives et canines supérieures



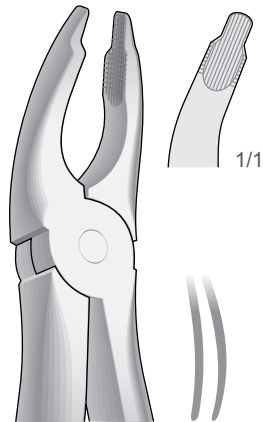
**S-34**  
 Fig. 34

Obere Schneide- und Eckzähne  
 Upper incisors and cuspids  
 Incisivi e canini superiori  
 Incisivos y caninos superiores  
 Incisives et canines supérieures



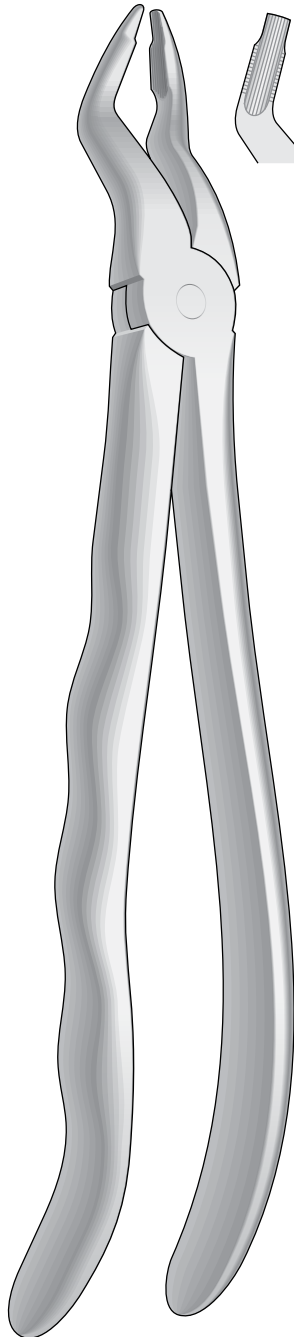
**S-7**  
 Fig. 7

Obere Prämolaren  
 Upper premolars  
 Premolari superiori  
 Premolares superiores  
 Prémolaires supérieures



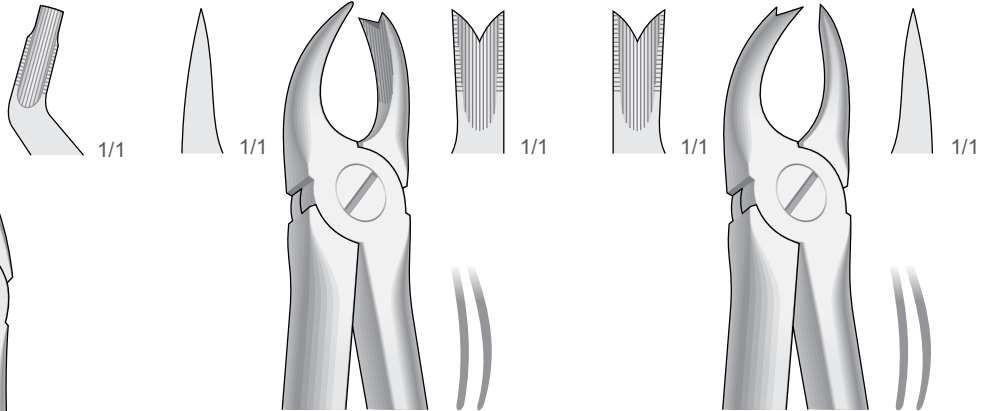
**S-35**  
 Fig. 35

Obere Schneidezähne und Prämolaren, tiefgreifend  
 Upper incisors and bicuspid, deep-gripping  
 Incisivi e premolari superiori, presa in profondità  
 Incisivos y premolares superiores, a gran calado  
 Incisives et prémolaires supérieures, à attaque profonde



**S-31**  
 Fig. 31

Obere Prämolaren  
 Upper premolars  
 Premolari superiori  
 Premolares superiores  
 Prémolaires supérieures



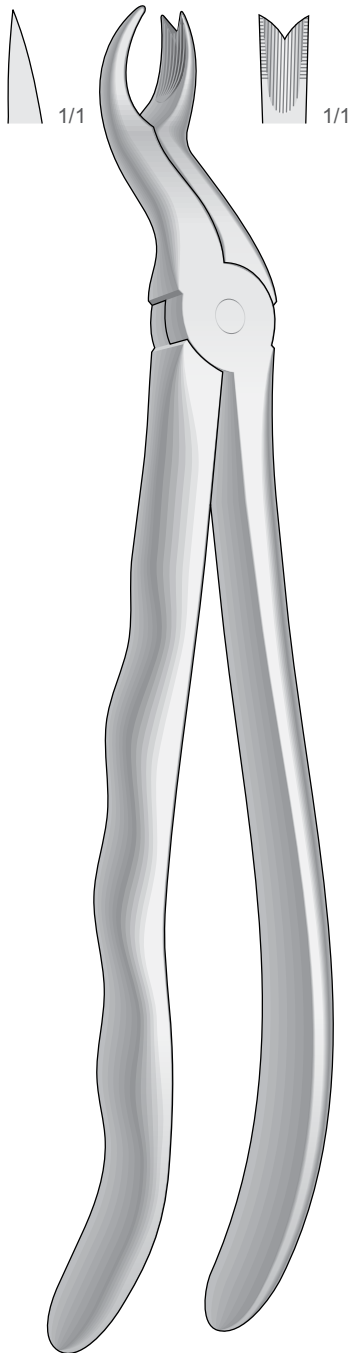
**S-66R**  
 Fig. 66R (89)

Obere Molaren, rechts  
 Upper molars, right  
 Molari superiori, destra  
 Molares superiores, derechos  
 Molaires supérieures, droites

**S-66L**  
 Fig. 66L (90)

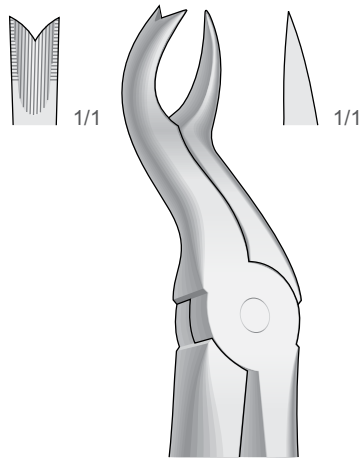
Obere Molaren, links  
 Upper molars, left  
 Molari superiori, sinistra  
 Molares superiores, izquierdos  
 Molaires supérieures, gauches

Zahnzangen, Paßformgriff  
 Extracting Forceps, Anatomical Handle  
 Pinze per estrazione, Manico anatomico  
 Pinzas da extracción, Mango anatómico  
 Daviers, Manche anatomique



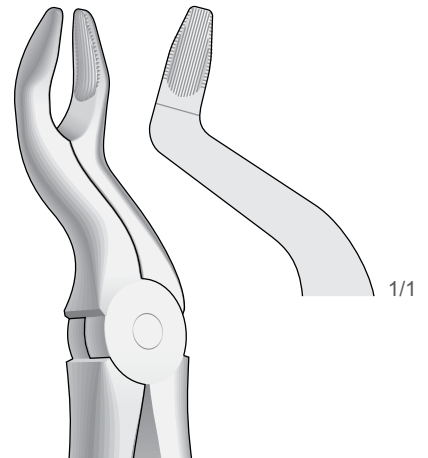
**S-67R**  
 Fig. 67R

Obere Molaren, rechts  
 Upper molars, right  
 Molari superiori, destra  
 Molares superiores, derechos  
 Molaires supérieures, droites



**S-67L**  
 Fig. 67L

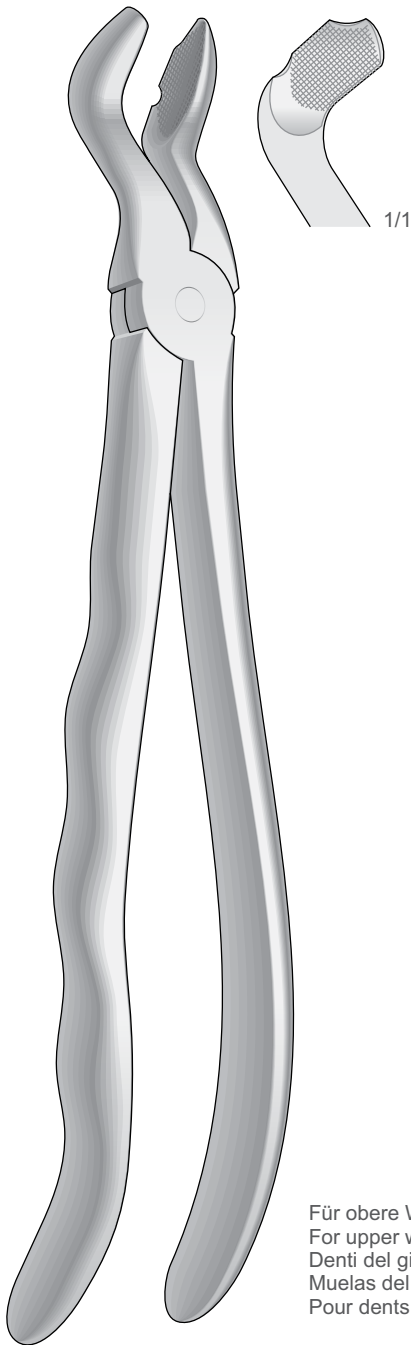
Obere Molaren, links  
 Upper molars, left  
 Molari superiori, sinistra  
 Molares superiores, izquierdos  
 Molaires supérieures, gauches



**S-67N**  
 Fig. 67N

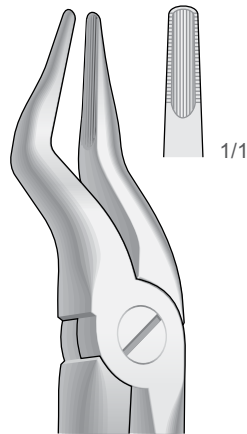
Obere Molaren  
 Upper molars  
 Molari superiori  
 Molares superiores  
 Molaires supérieures

Zahnzangen, Paßformgriff  
 Extracting Forceps, Anatomical Handle  
 Pinze per estrazione, Manico anatomico  
 Pinzas da extracción, Mango anatómico  
 Daviers, Manche anatomique



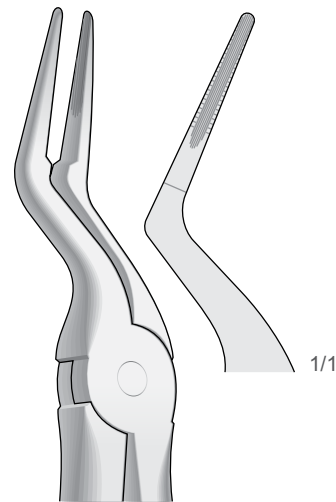
FELSCH  
**S-80**  
 Fig. 80

Für obere Weisheitszähne, mit Fangvorrichtung  
 For upper wisdom teeth, with retaining device  
 Denti del giudizio superiori, con dispositivo di presa  
 Muelas del juicio superiores, con dispositivo de retencion  
 Pour dents de sagesse supérieures, mors conçus pour recueillir la dent



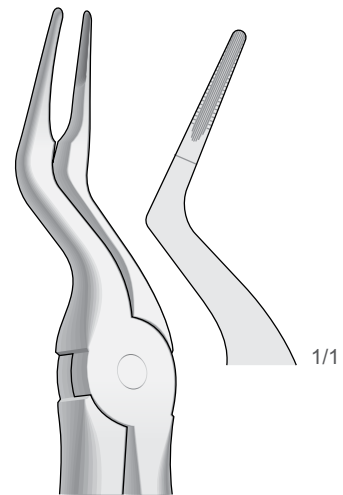
**S-51B**  
 Fig. 51B

Obere Dritte Molaren  
 Upper molars  
 Ottavi superiori  
 Molares superiores  
 Molaires supérieures



**S-97**  
 Fig. 97

Obere Wurzelplitterzange  
 Upper Root Fragments  
 Frammenti e radici superiori  
 Fragmentos de raíces superiores  
 Fragments des racines supérieures



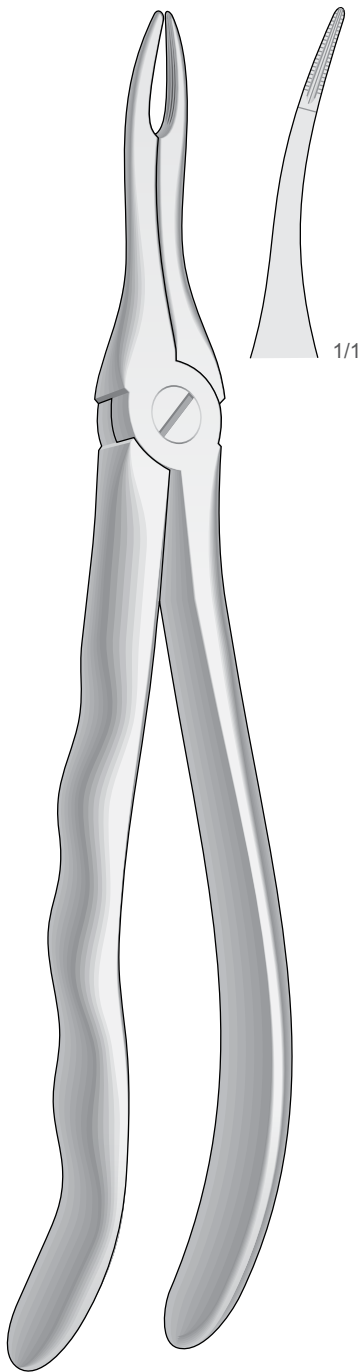
**S-97B**  
 Fig. 97B

Obere Wurzelplitterzange  
 Upper Root Fragments  
 Frammenti e radici superiori  
 Fragmentos de raíces superiores  
 Fragments des racines supérieures

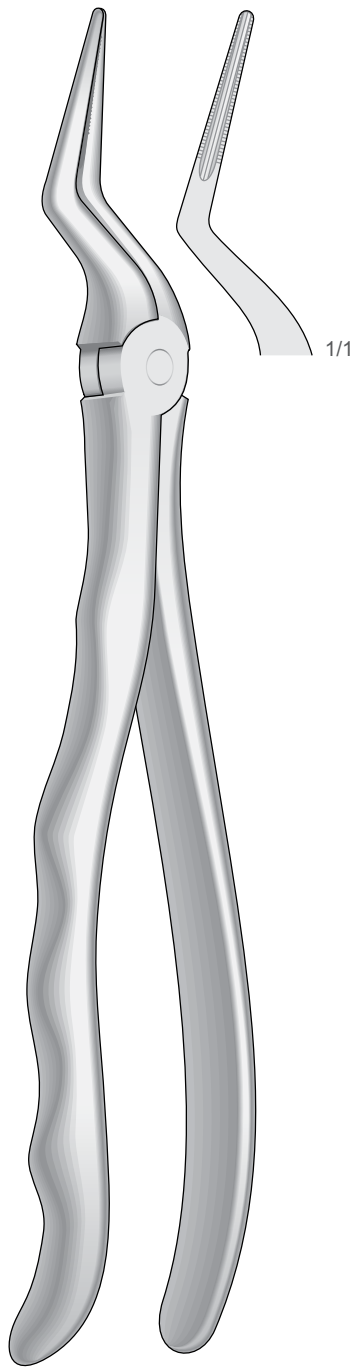


Zahnzangen, Paßformgriff  
 Extracting Forceps, Anatomical Handle  
 Pinze per estrazione, Manico anatomico  
 Pinzas da extracción, Mango anatómico  
 Daviers, Manche anatomique

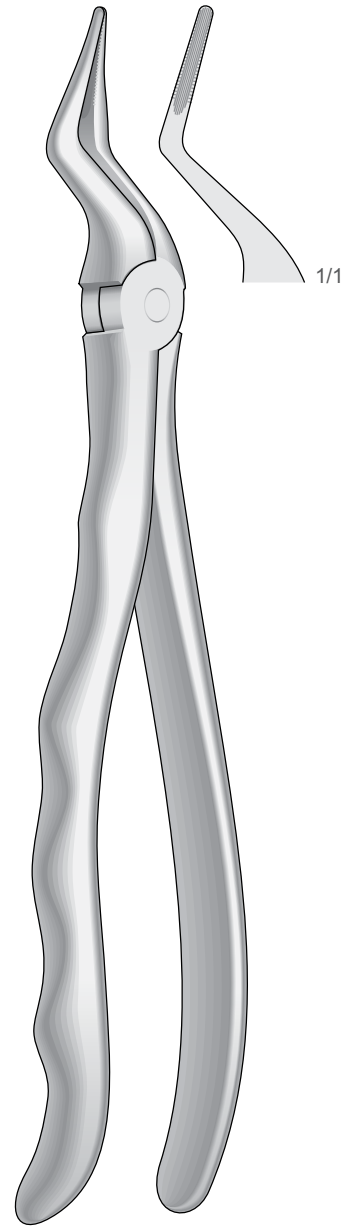
Obere Wurzeln sehr feine  
 Upper very fine roots  
 Radici superiori molto sottili  
 Raíces superiores muy finas  
 Racines supérieures très fines



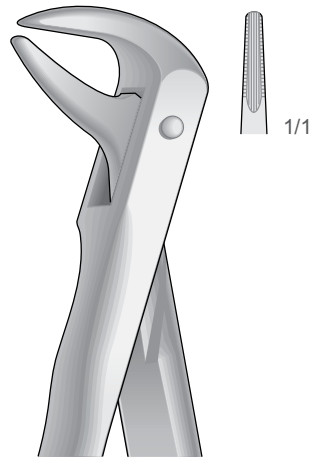
**S-49**  
 Fig. 49



**S-51LX**  
 Fig. 51LX

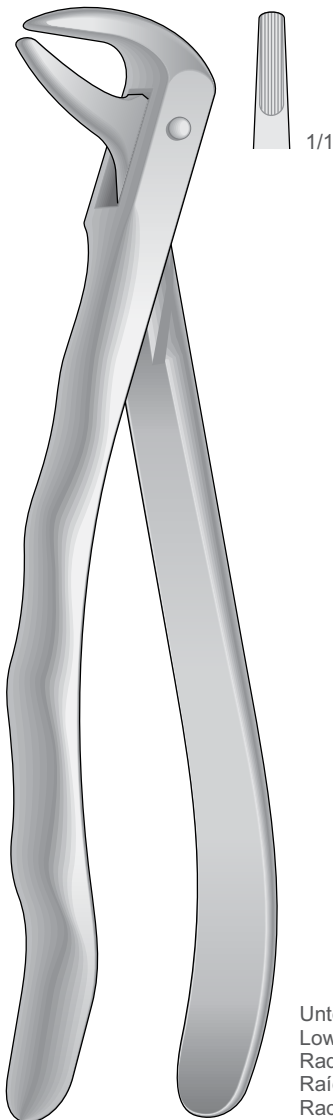


**S-351S**  
 Fig. 351S

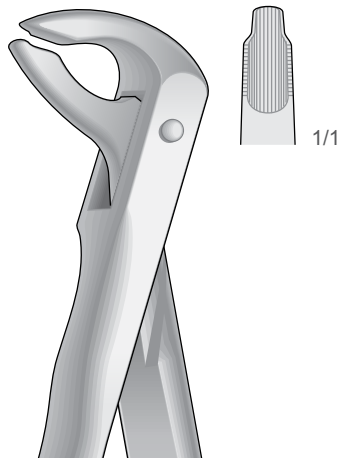


**I-74N**  
 Fig. 74N

Untere Wurzeln Schneide- und Eckzähne  
 Lower roots, incisors and cuspids  
 Radici, incisivi e canini inferiori  
 Raíces, incisivos y caninos inferiores  
 Racines, incisives et canines inférieures

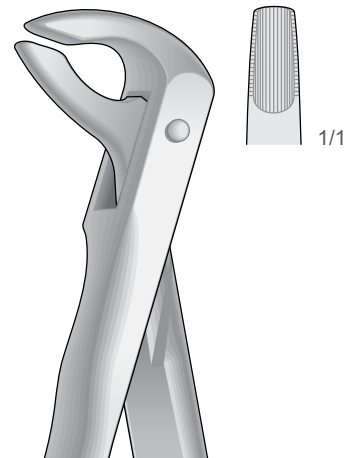


**I-74**  
 Fig. 74



**I-36**  
 Fig. 36

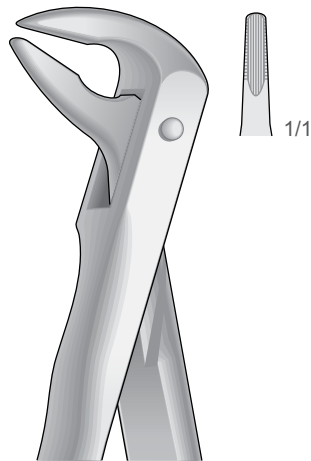
Untere Wurzeln Schneide- und Eckzähne  
 Lower roots, incisors and cuspids  
 Radici, incisivi e canini inferiori  
 Raíces, incisivos y caninos inferiores  
 Racines, incisives et canines inférieures



**I-36N**  
 Fig. 36N

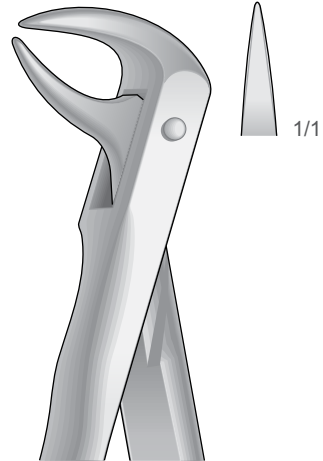
Untere Wurzeln Schneide- und Eckzähne  
 Lower roots, incisors and cuspids  
 Radici, incisivi e canini inferiori  
 Raíces, incisivos y caninos inferiores  
 Racines, incisives et canines inférieures

Zahnzangen, Paßformgriff  
 Extracting Forceps, Anatomical Handle  
 Pinze per estrazione, Manico anatomico  
 Pinzas da extracción, Mango anatómico  
 Daviers, Manche anatomique



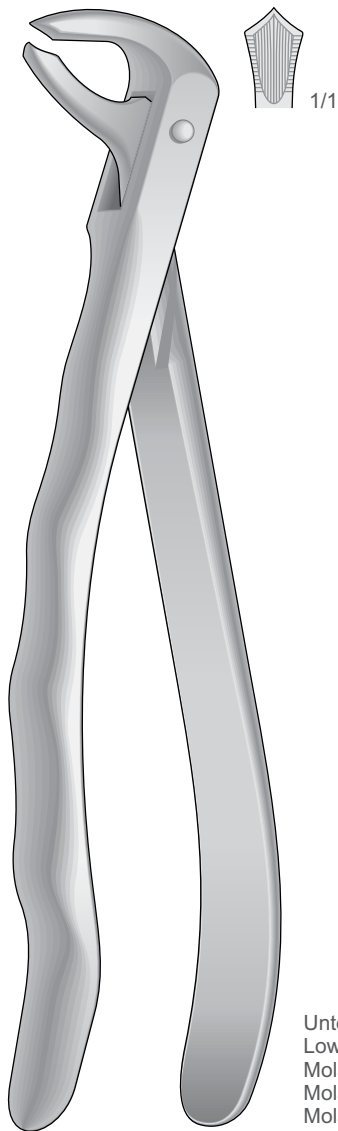
**I-59**  
 Fig. 59

Untere Wurzelplitterzange  
 Lower Root Fragments  
 Frammenti e radici inferiori  
 Fragmentos de raíces inferiores  
 Fragments des racines inférieures



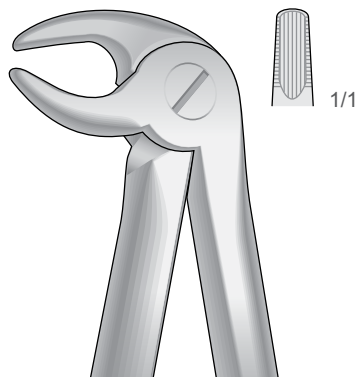
**I-86C**  
 Fig. 86C

Untere Molaren mit kariesen oder abgebrochenen Kronen  
 Lower molars with carious or broken caps  
 Molari inferiori con corone cariate o spezzate  
 Molares inferiores con coronas rotas o cariadas  
 Molaire inférieures avec couronnes cariées ou cassées



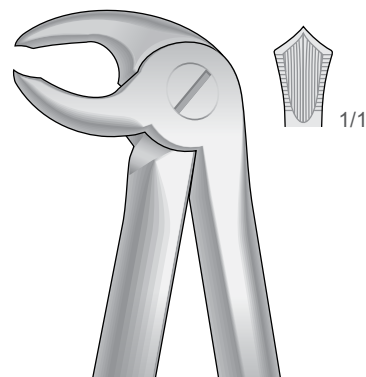
**I-73**  
 Fig. 73

Untere Molaren  
 Lower molars  
 Molari inferiori  
 Molares inferiores  
 Molaire inférieures



**I-13**  
 Fig. 13

Untere Prämolaren und Eckzähne  
 Lower premolars and cuspids  
 Canini e premolari inferiori  
 Caninos y premolares inferiores  
 Canines et prémolaires inférieures



**I-22**  
 Fig. 22

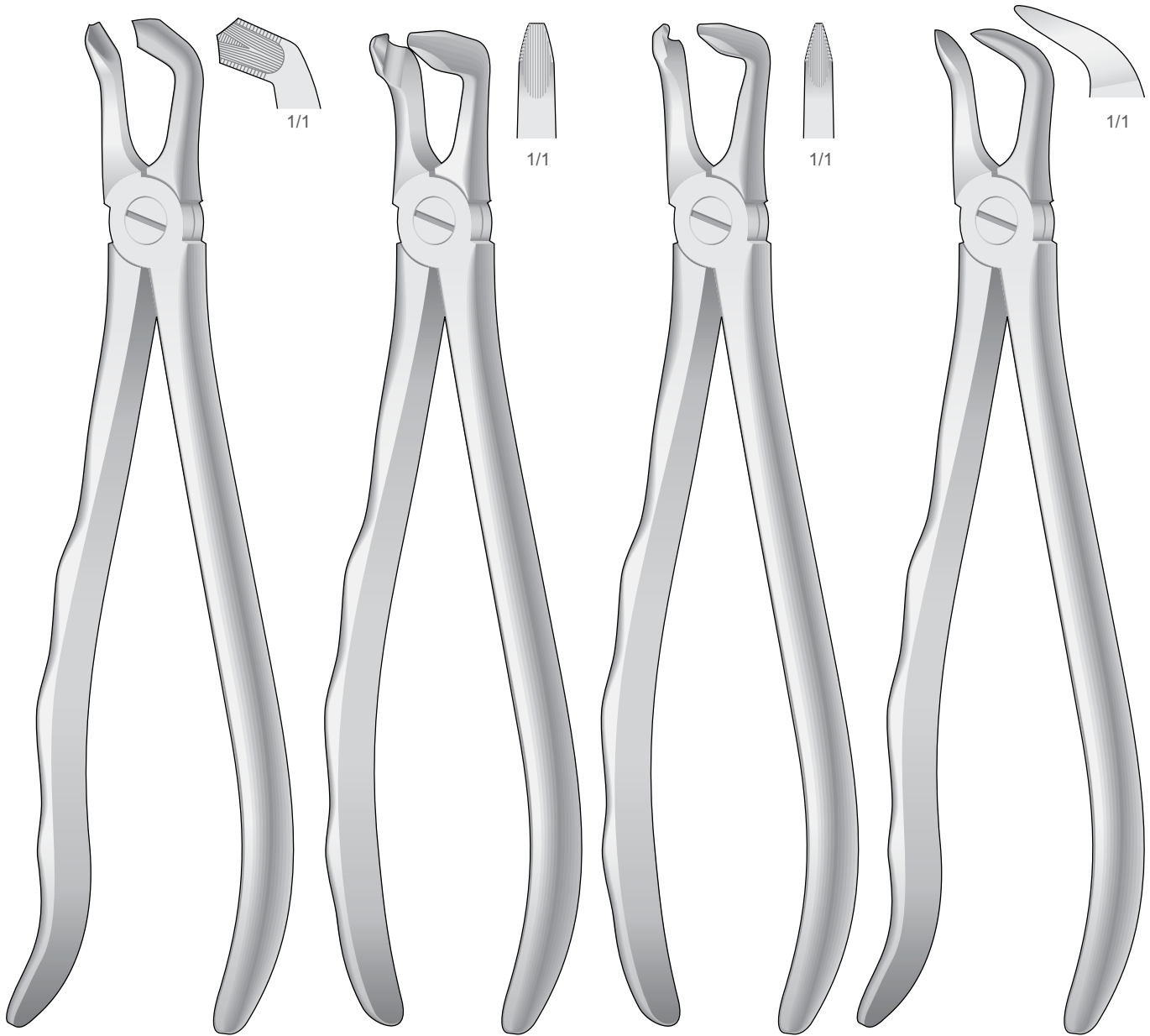
Untere Molaren  
 Lower molars  
 Molari inferiori  
 Molares inferiores  
 Molaire inférieures

Zahnzangen, Paßformgriff  
 Extracting Forceps, Anatomical Handle  
 Pinze per estrazione, Manico anatomico  
 Pinzas da extracción, Mango anatómico  
 Daviers, Manche anatomique

Untere Weisheitszähne  
 Lower wisdom teeth  
 Denti del giudizio inferiori  
 Muelas del juicio inferiores  
 Dent de sagesse inférieures

Untere Prämolaren  
 Lower premolars  
 Premolari inferiori  
 Premolares inferiores  
 Prémolaires inférieures

Untere Molaren  
 Lower Molars  
 Molari inferiori  
 Molares inferiores  
 Molaires inférieures



**I-79**  
 Fig. 79

**I-79N**  
 Fig. 79N

**I-46N**  
 Fig. 46N

**I-87**  
 Fig. 87

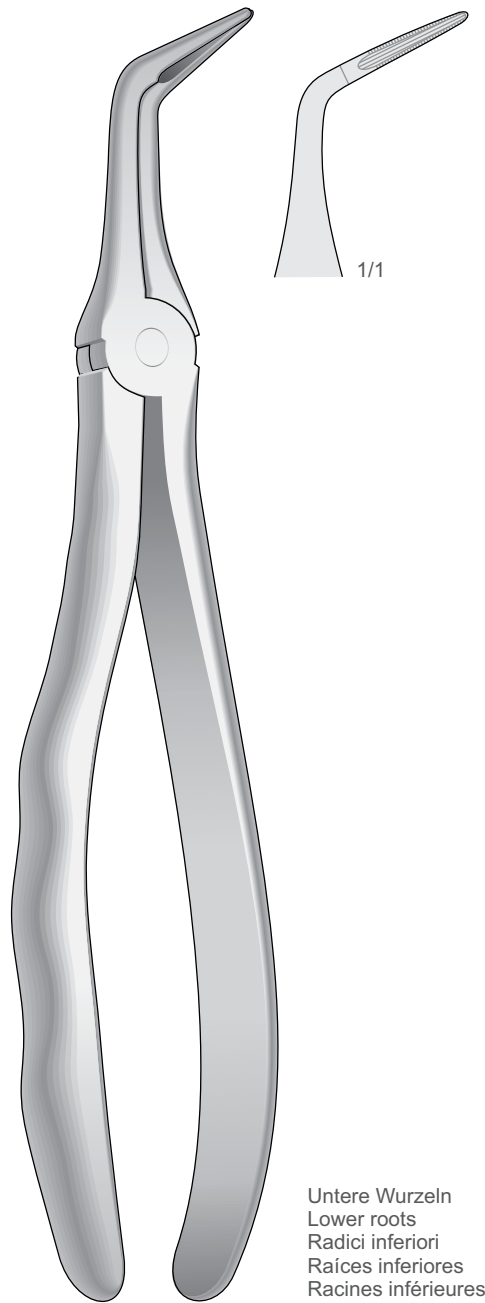


Zahnzangen, Paßformgriff  
Extracting Forceps, Anatomical Handle  
Pinze per estrazione, Manico anatomico  
Pinzas da extracción, Mango anatómico  
Daviers, Manche anatomique

FORCEPS



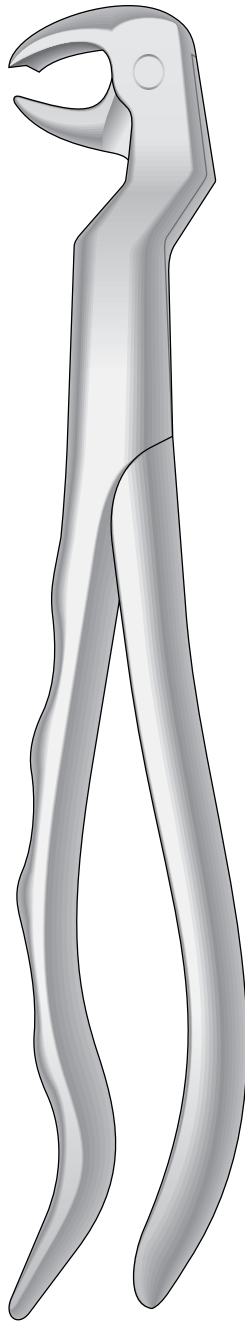
**I-46LX**  
Fig. 46LX



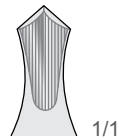
**I-46L**  
Fig. 46L

Zahnzangen, Paßformgriff  
 Extracting Forceps, Anatomical Handle  
 Pinze per estrazione, Manico anatomico  
 Pinzas da extracción, Mango anatómico  
 Daviers, Manche anatomique

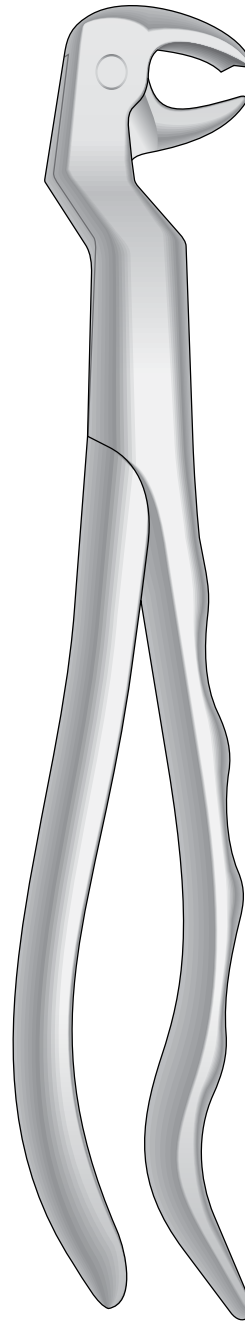
Untere Molaren und Weisheitszähne  
 Lower molars and wisdom teeth  
 Molari e denti del giudizio inferiori  
 Molares y muelas del juicio inferiores  
 Molaires et dent de sagesse inférieures



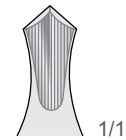
I-22 1/2 L



Links  
 Left  
 Sinistra  
 Izquierdos  
 Gauches



I-22 1/2 R

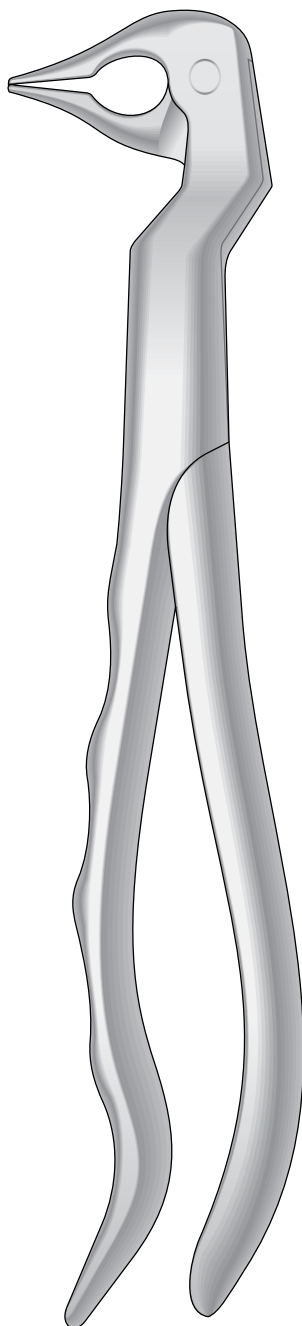


Rechts  
 Right  
 Destra  
 Derechos  
 Droites



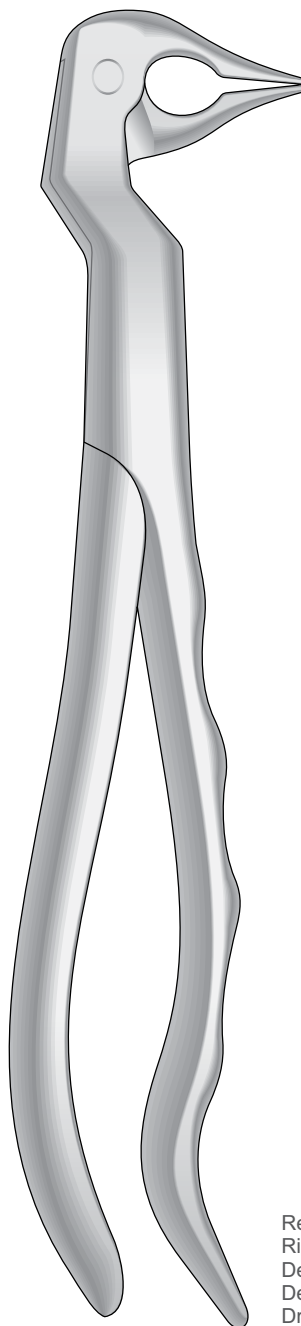
Zahnzangen, Paßformgriff  
 Extracting Forceps, Anatomical Handle  
 Pinze per estrazione, Manico anatomico  
 Pinzas da extracción, Mango anatómico  
 Daviers, Manche anatomique

Untere Wurzeln sehr feine  
 Lower very fine roots  
 Radici inferiori molto sottili  
 Raíces inferiores muy finas  
 Racines inférieures très fines



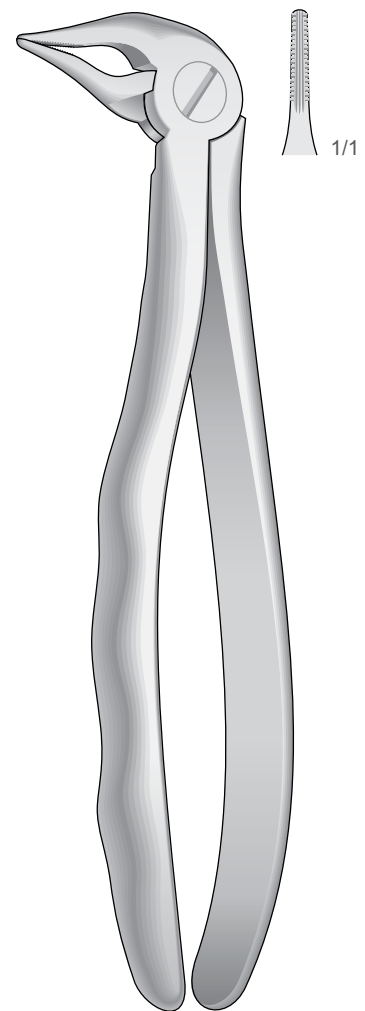
Links  
 Left  
 Sinistra  
 Izquierdos  
 Gauches

**I-133 L**  
 Fig.133



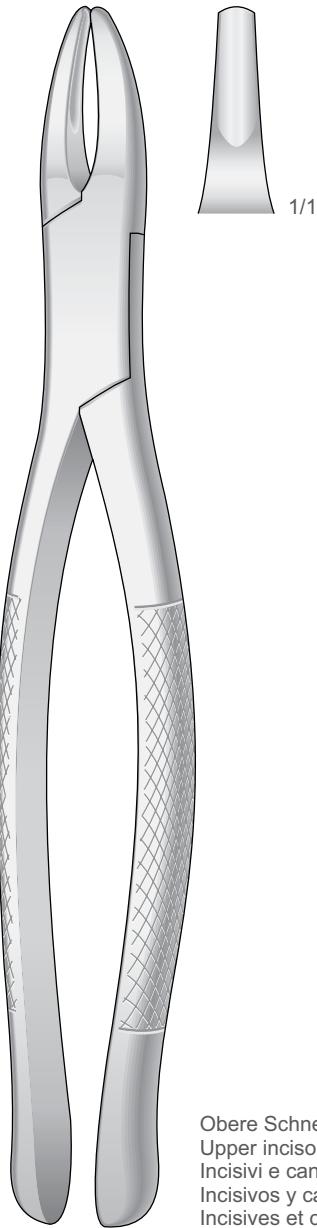
Rechts  
 Right  
 Destra  
 Derechos  
 Droites

**I-133 R**  
 Fig.133



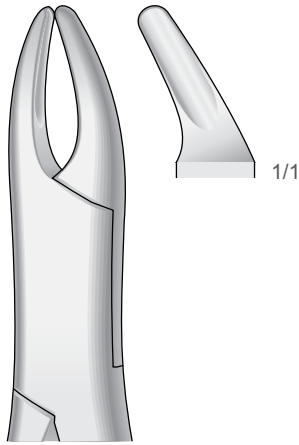
**I-333S**  
 Fig.333S

Zahnzangen, Amerikanische Form  
 Extracting Forceps, American Pattern  
 Pinze per estrazione, Forma Americana  
 Pinzas da extracción, Forma Americana  
 Daviers, Forme Américaine



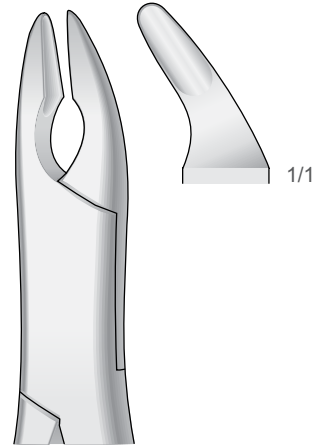
**AM-1**  
 Fig. 1

Obere Schneide- und Eckzähne  
 Upper incisors and cuspids  
 Incisivi e canini superiori  
 Incisivos y caninos superiores  
 Incisives et canines supérieures



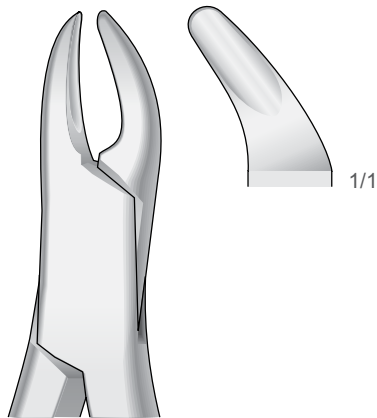
**CRYER**  
**AM-150**  
 Fig. 150

Obere Prämolaren, Schneidezähne, Wurzeln  
 Upper Bicuspid, incisors and roots  
 Premolari, incisivi e radici superiori  
 Premolares, incisivos y raíces superiores  
 Prémolaires, incisives et racines supérieures



**CRYER**  
**AM-150A**  
 Fig. 150A

Obere Prämolaren, Schneidezähne, Wurzeln  
 Upper Bicuspid, incisors and roots  
 Premolari, incisivi e radici superiori  
 Premolares, incisivos y raíces superiores  
 Prémolaires, incisives et racines supérieures

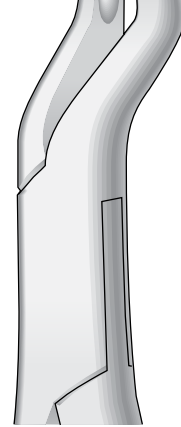
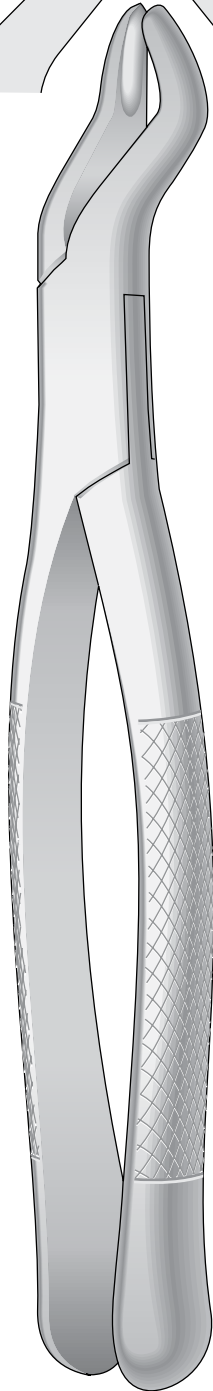
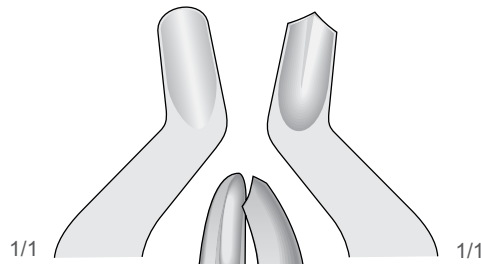
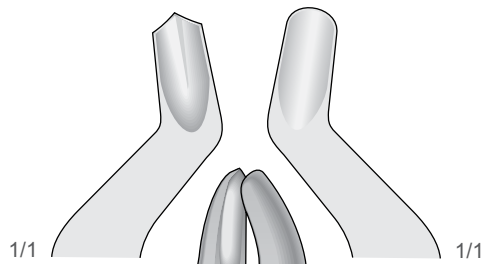


**AM-62**  
 Fig. 62

Schneidezähne, Prämolaren, Milchzähne  
 Incisors, premolars, deciduous teeth  
 Incisivi, premolari, denti da latte  
 Incisivos, premolares, dientes de leche  
 Incisives, prémolaires, dents de lait

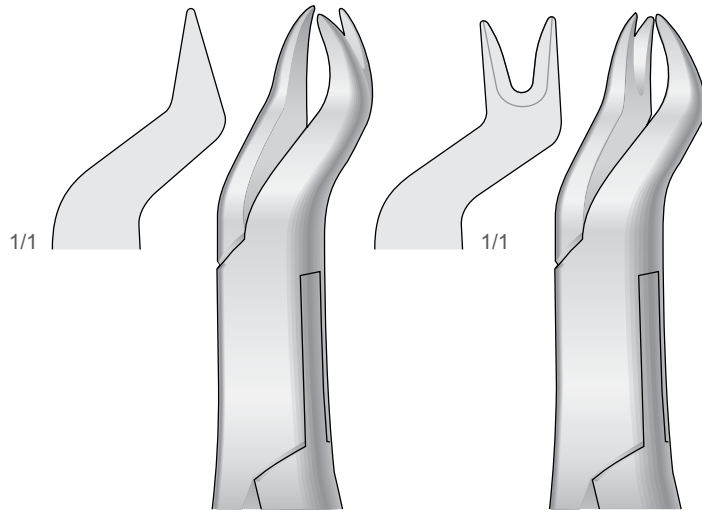


Zahnzangen, Amerikanische Form  
 Extracting Forceps, American Pattern  
 Pinze per estrazione, Forma Americana  
 Pinzas da extracción, Forma Americana  
 Daviers, Forme Américaine



**AM-53L**  
 Fig. 53L

Obere Molaren, Links  
 Upper Molars, Left  
 Molari superiori, Sinistra  
 Molares superiores, Izquierdos  
 Molaires supérieures, Gauches



NEVIUS  
**AM-88R**  
 Fig. 88R

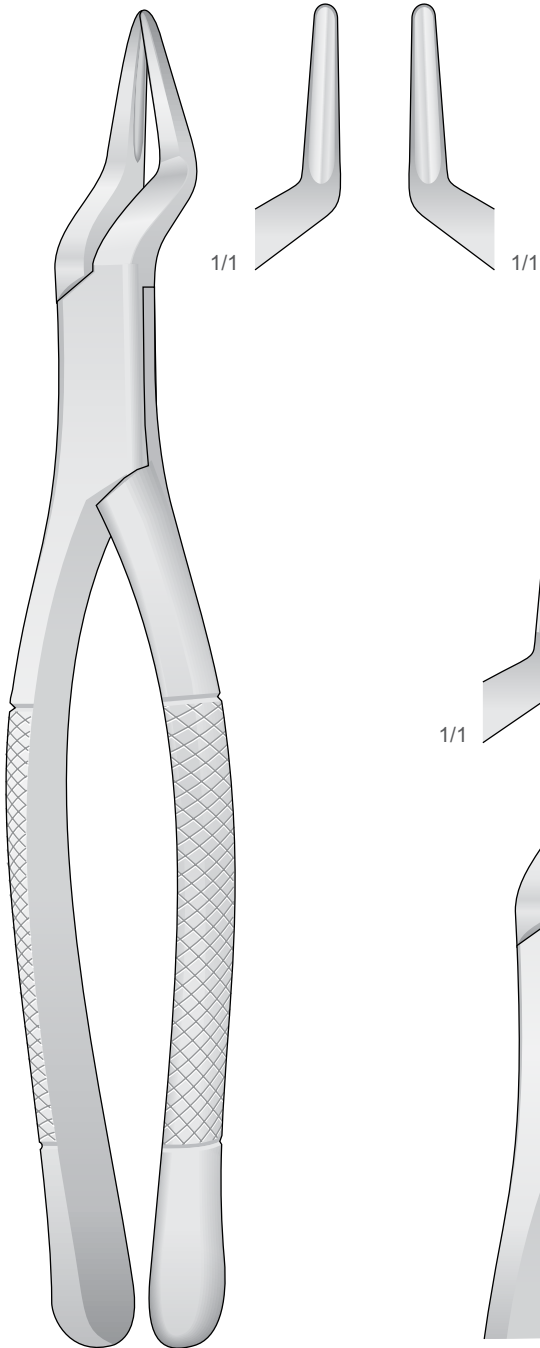
Obere Molaren, Rechts  
 Upper Molars, Right  
 Molari superiori, Destra  
 Molares superiores, Derechos  
 Molaires supérieures, Droites

NEVIUS  
**AM-88L**  
 Fig. 88L

Obere Molaren, Links  
 Upper Molars, Left  
 Molari superiori, Sinistra  
 Molares superiores, Izquierdos  
 Molaires supérieures, Gauches

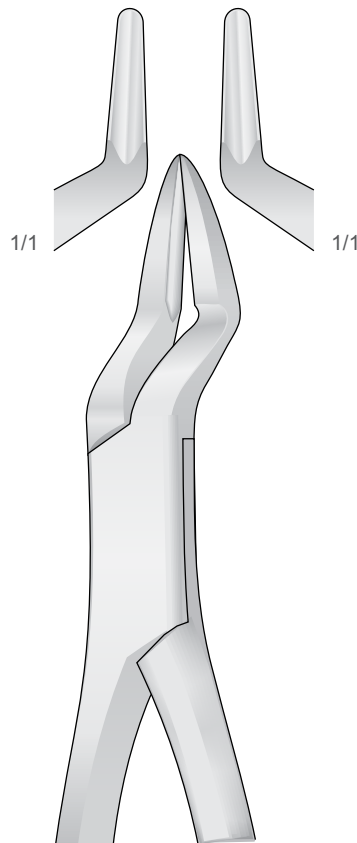
**AM-53R**  
 Fig. 53R





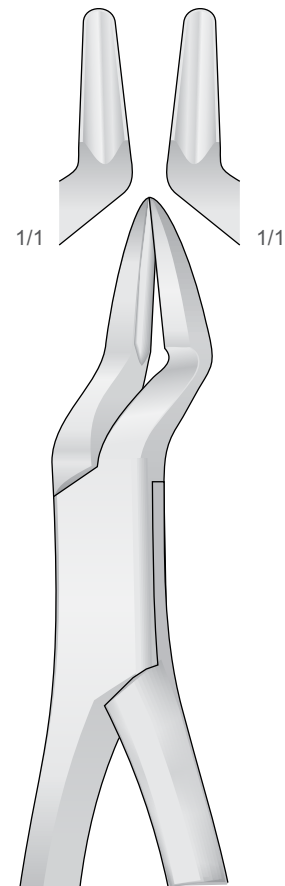
**AM-65**  
 Fig.65

Obere Schneidezähne und Wurzeln  
 Upper Incisors and Roots  
 Incisivi e radici superiori  
 Incisivos y raíces superiores  
 Incisives et racines supérieures



PARMLY  
**AM-32A**  
 Fig. 32A

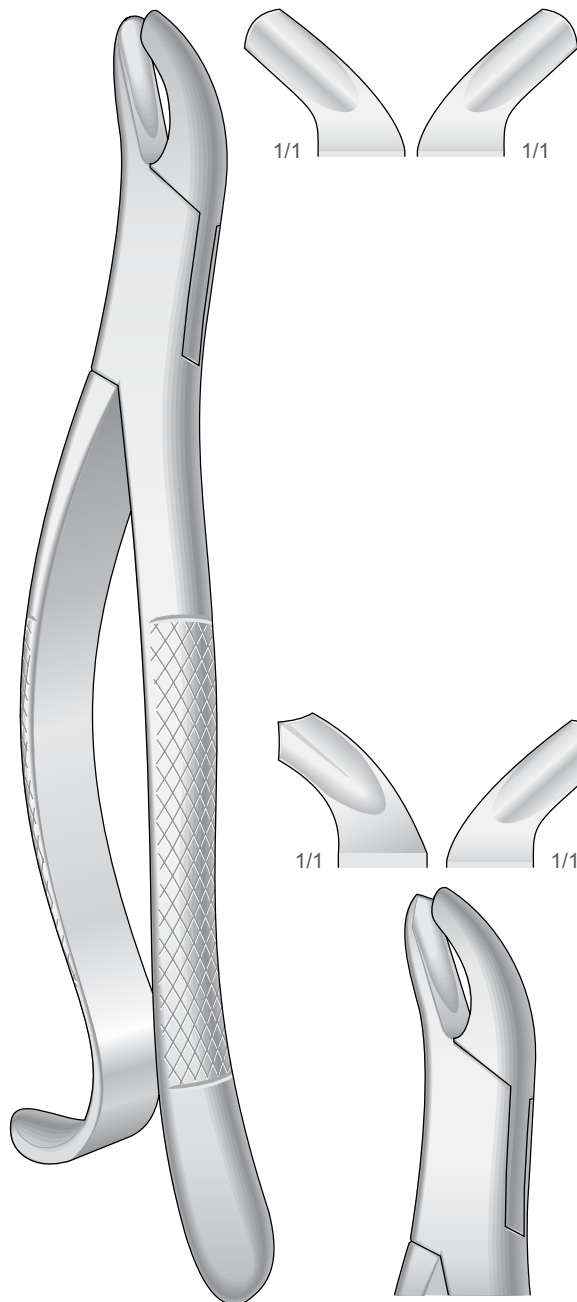
Obere Wurzeln und Prämolaren  
 Upper Roots and Premolars  
 Radici e premolari superiori  
 Raices y premolares superiores  
 Racines et prémolaires supérieures



PARMLY  
**AM-32**  
 Fig. 32

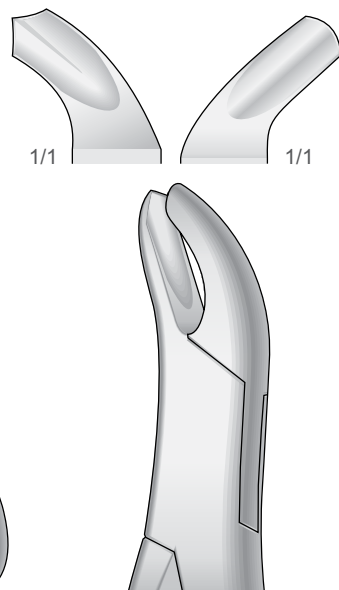
Obere Prämolaren und Molaren  
 Upper Premolars and Molars  
 Premolari e molari superiori  
 Premolares y Molares superiores  
 Prémolaires et Molaires supérieures

Zahnzangen, Amerikanische Form  
 Extracting Forceps, American Pattern  
 Pinze per estrazione, Forma Americana  
 Pinzas da extracción, Forma Americana  
 Daviers, Forme Américaine



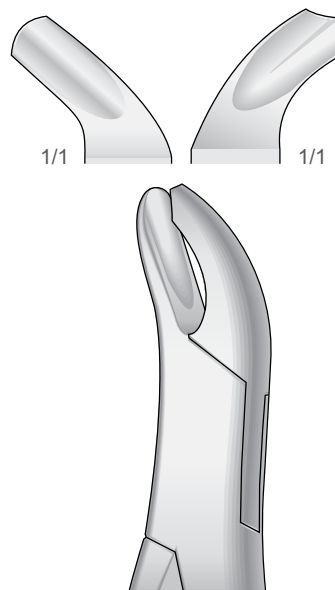
**AM-24**  
 Fig. 24

Obere Molaren  
 Upper Molars  
 Molari superiori  
 Molares superiores  
 Molaires supérieures



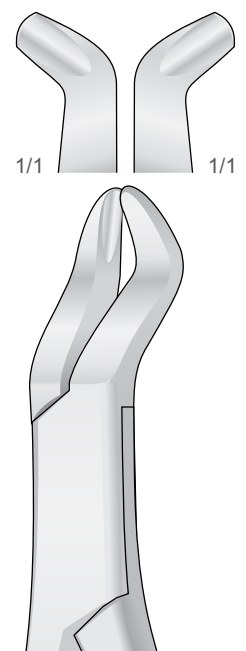
HARRIS  
**AM-18R**  
 Fig. 18R

Obere Molaren, Rechts  
 Upper Molars, Right  
 Molari superiori, Destra  
 Molares superiores, Derechos  
 Molaires supérieures, Droites



HARRIS  
**AM-18L**  
 Fig. 18L

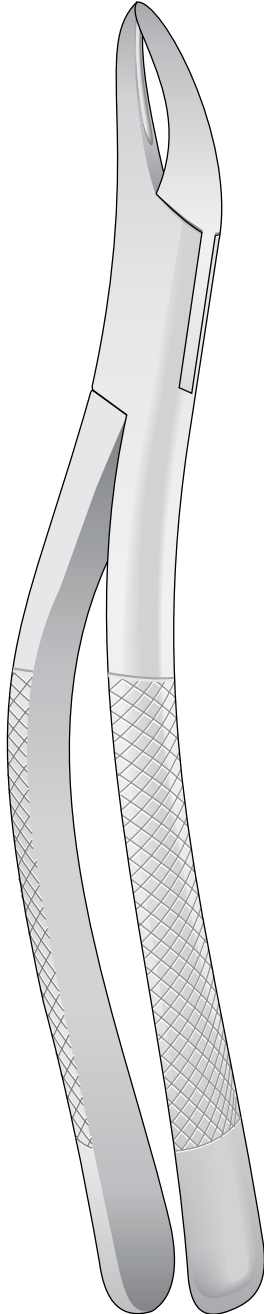
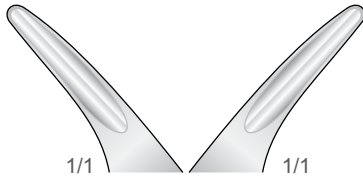
Obere Molaren, Links  
 Upper Molars, Left  
 Molari superiori, Sinistra  
 Molares superiores, Isquierdos  
 Molaires supérieures, Gauches



**AM-210**  
 Fig. 210

Obere Molaren  
 Upper Molars  
 Molari superiori  
 Molares superiores  
 Molaires supérieures

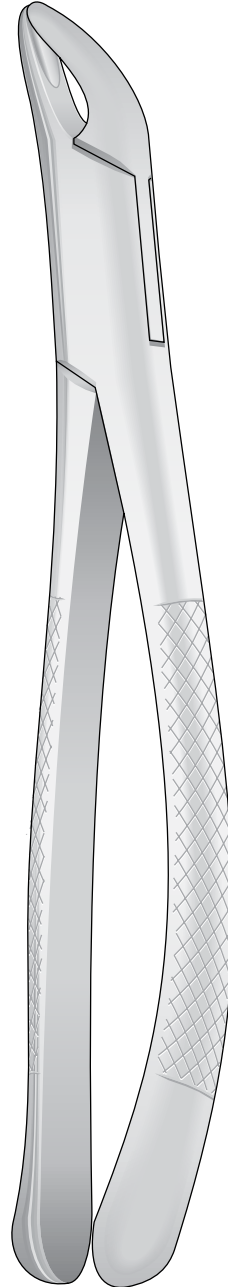
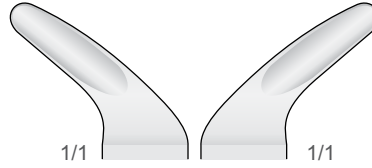
Zahnzangen, Amerikanische Form  
 Extracting Forceps, American Pattern  
 Pinze per estrazione, Forma Americana  
 Pinzas da extracción, Forma Americana  
 Daviers, Forme Américaine



TOMES  
**AM-69**  
 Fig.69

Obere und Untere  
 Upper and lower  
 Superiori e inferiori  
 Superiores y inferiores  
 Supérieures et inférieures

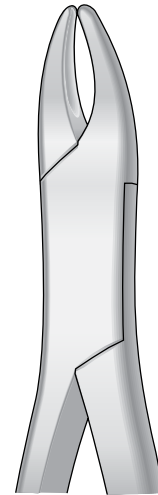
Wurzeln  
 Roots  
 Radici  
 Raices  
 Racines



CRYER  
**AM-151**  
 Fig.151

Untere  
 Lower  
 Inferiori  
 Inferiores  
 Inférieures

Schneidezähne, Prämolaren, Wurzeln  
 Incisors, Premolars, Roots  
 Incisivi, premolari, radici  
 Incisivos, premolares, raices  
 Incisives, prémolaires, racines

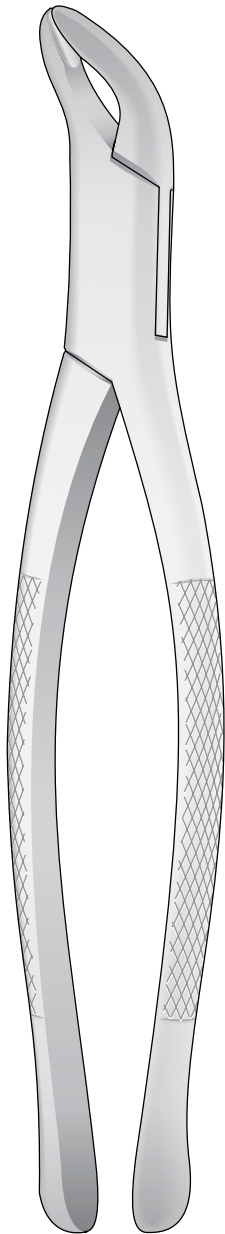
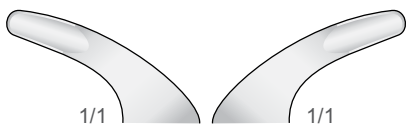


HULL  
**AM-101**  
 Fig. 101

Für Eckzähne und Prämolaren,  
 Universalzange und Kinderzange  
 For canines and Premolars,  
 Universal and Tooth forceps for children  
 Canini e premolari,  
 universale e per bambini  
 Caninos y premolares,  
 universal y para niños  
 Canines et prémolaires,  
 universel et pour enfants

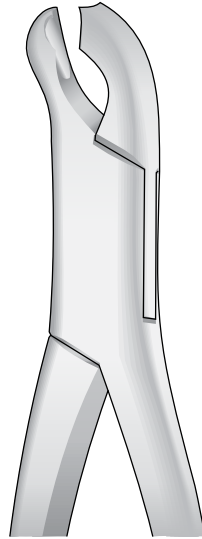
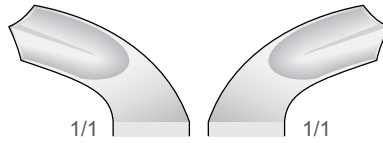


Zahnzangen, Amerikanische Form  
 Extracting Forceps, American Pattern  
 Pinze per estrazione, Forma Americana  
 Pinzas da extracción, Forma Americana  
 Daviers, Forme Américaine



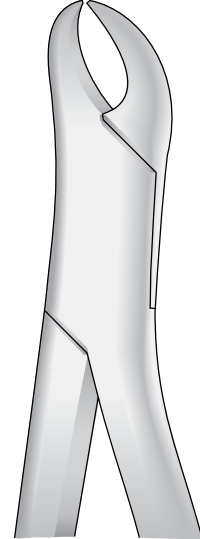
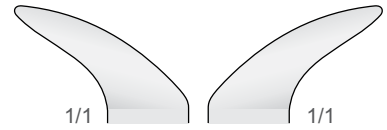
**AM-203**  
 Fig. 203

Untere Schneidezähne, Prämolaren, Wurzeln  
 Lower Incisors, Premolars, Roots  
 Incisivi, premolari, radici inferiori  
 Incisivos, premolares, raices inferiores  
 Incisives, prémolaires, racines inférieures



**AM-17**  
 Fig. 17

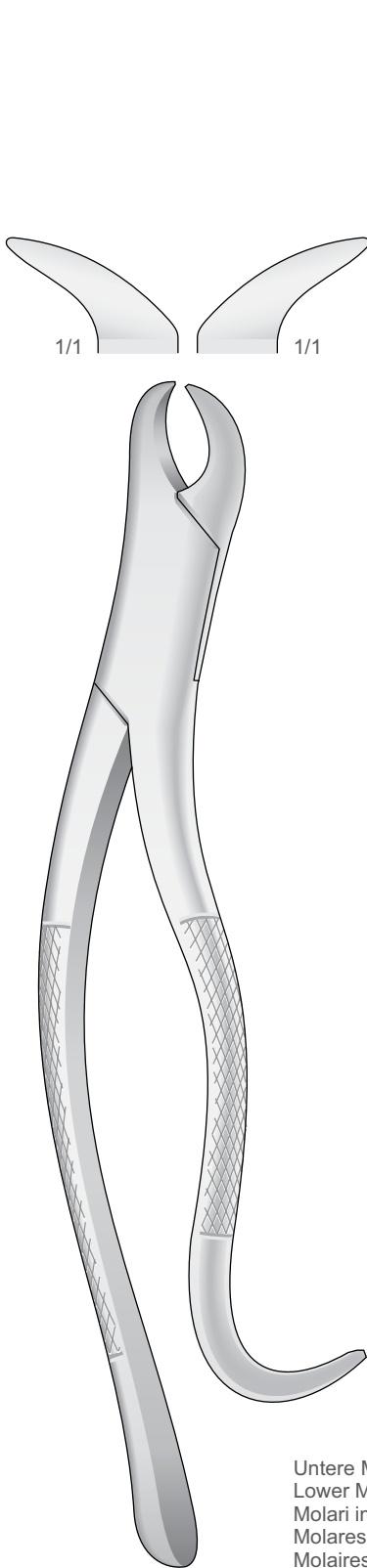
Untere Molaren  
 Lower Molars  
 Molari inferiori  
 Molares inferiores  
 Molaires inférieures



**AM-23**  
 Fig. 23

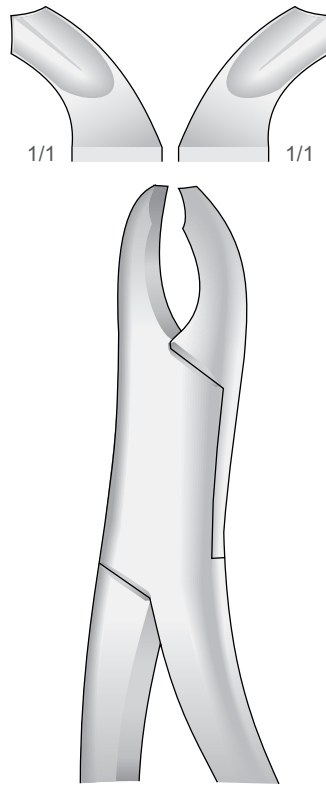
Untere Molaren  
 Lower Molars  
 Molari inferiori  
 Molares inferiores  
 Molaires inférieures

Zahnzangen, Amerikanische Form  
 Extracting Forceps, American Pattern  
 Pinze per estrazione, Forma Americana  
 Pinzas da extracción, Forma Americana  
 Daviers, Forme Américaine



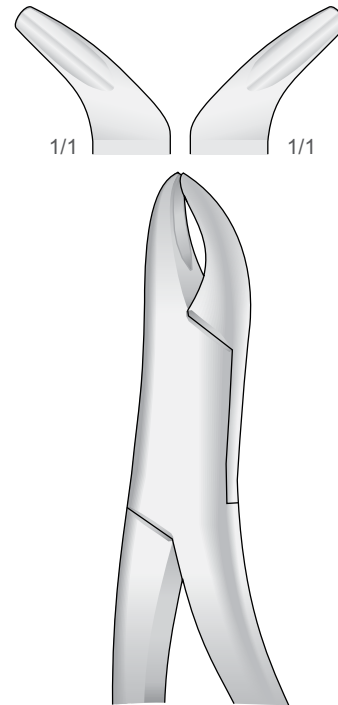
**AM-16**  
 Fig. 16

Untere Molaren  
 Lower Molars  
 Molari inferiori  
 Molares inferiores  
 Molaires inférieures



**HARRIS**  
**AM-15**  
 Fig. 15

Untere Molaren  
 Lower Molars  
 Molari inferiori  
 Molares inferiores  
 Molaires inférieures

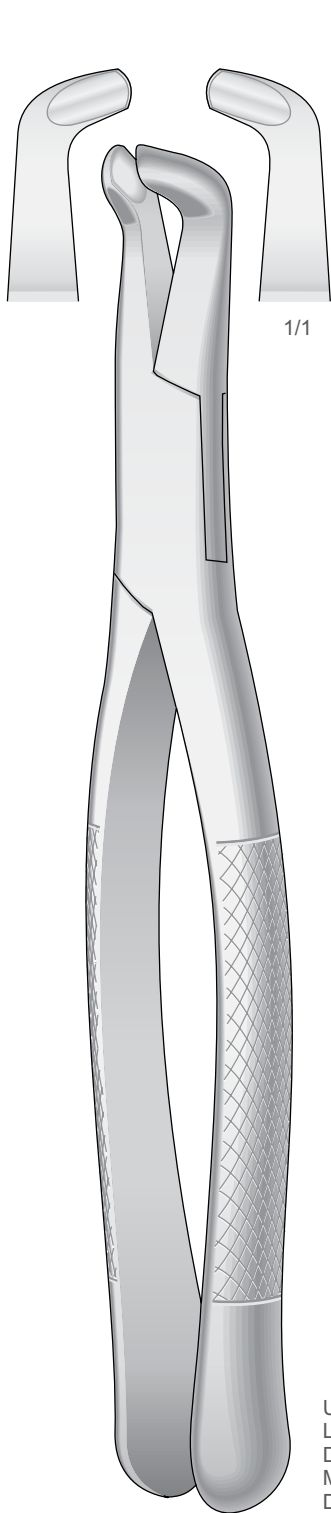


**AM-103**  
 Fig. 103

Untere Schneidezähne, Prämolaren, Wurzeln  
 Lower Incisors, Premolars, Roots  
 Incisivi, premolari, radici inferiori  
 Incisivos, premolares, raíces inferiores  
 Incisives, prémolaires, racines inférieures

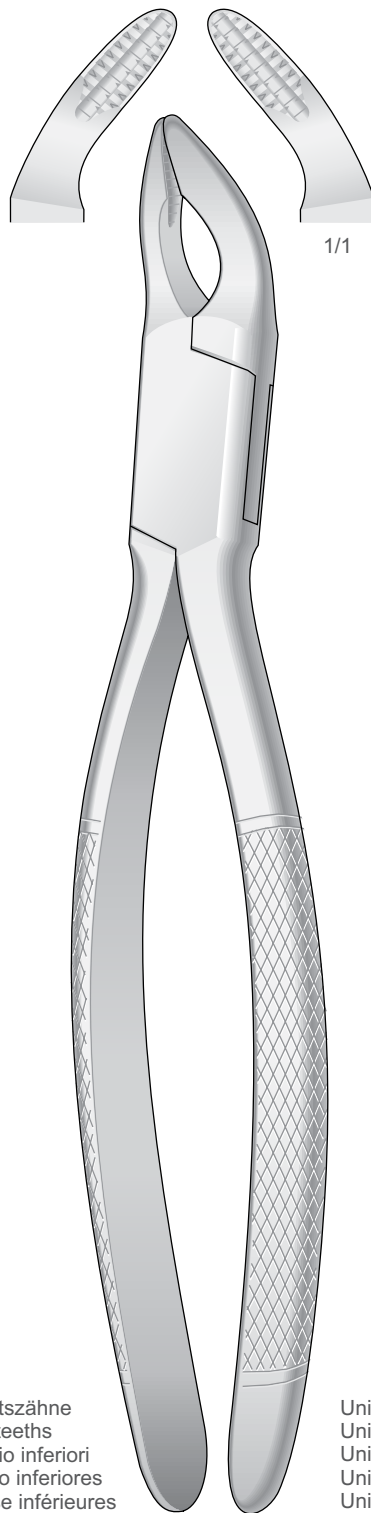


Zahnzangen, Amerikanische Form  
 Extracting Forceps, American Pattern  
 Pinze per estrazione, Forma Americana  
 Pinzas da extracción, Forma Americana  
 Daviers, Forme Américaine



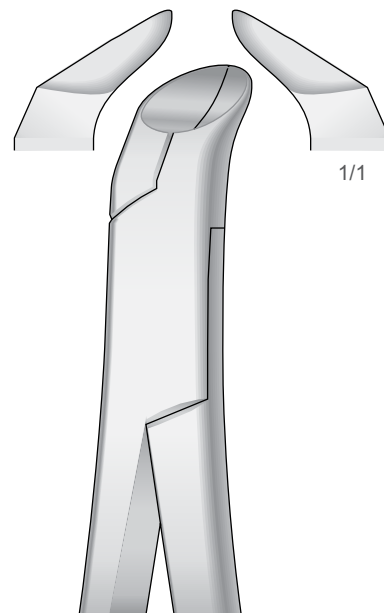
**AM-222**  
 Fig. 222

Untere Weisheitszähne  
 Lower wisdom teeth  
 Denti del giudizio inferiori  
 Muelas del juicio inferiores  
 Dent de sagesse inférieures



**COHEN**  
**AM-250**

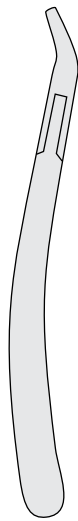
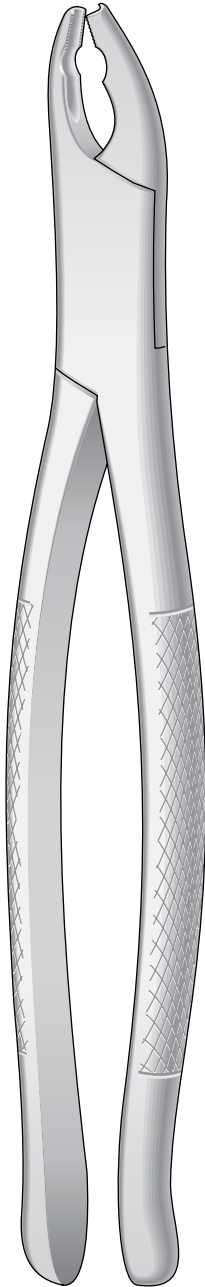
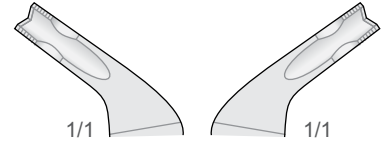
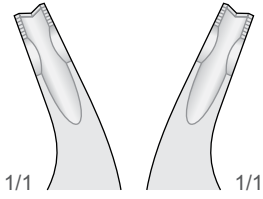
Universal  
 Universal  
 Universale  
 Universal  
 Universel



**PHYSICK**  
**AM-5**  
 Fig. 5

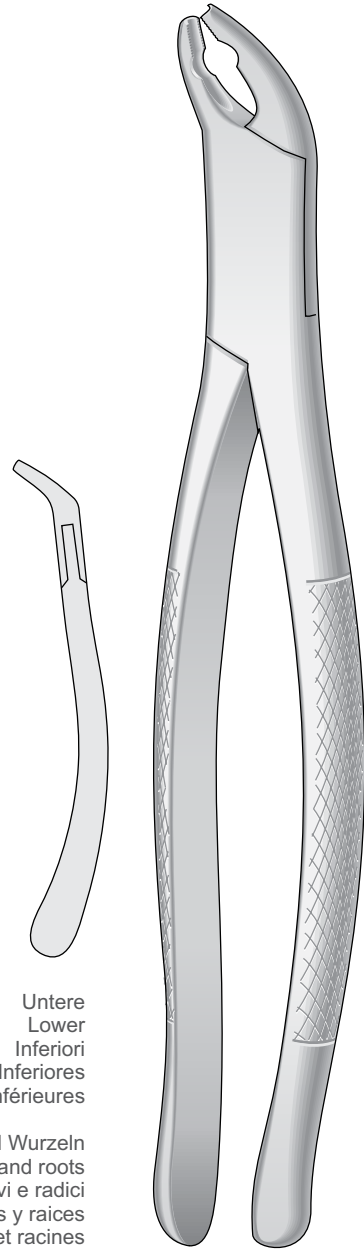
Untere Weisheitszähne  
 Lower wisdom teeth  
 Denti del giudizio inferiori  
 Muelas del juicio inferiores  
 Dent de sagesse inférieures

Zahnzangen, Amerikanische Form  
 Extracting Forceps, American Pattern  
 Pinze per estrazione, Forma Americana  
 Pinzas da extracción, Forma Americana  
 Daviers, Forme Américaine



Obere  
 Upper  
 Superiori  
 Superiores  
 Supérieures

Prämolaren, Schneidezähne und Wurzeln  
 Bicuspids, incisors and roots  
 Premolari, incisivi e radici  
 Premolares, incisivos y raices  
 Premolaires, incisives et racines



Untere  
 Lower  
 Inferiori  
 Inferiores  
 Inférieures

Prämolaren, Schneidezähne und Wurzeln  
 Bicuspids, incisors and roots  
 Premolari, incisivi e radici  
 Premolares, incisivos y raices  
 Premolaires, incisives et racines

**AM-150X**  
 Fig. 150AS

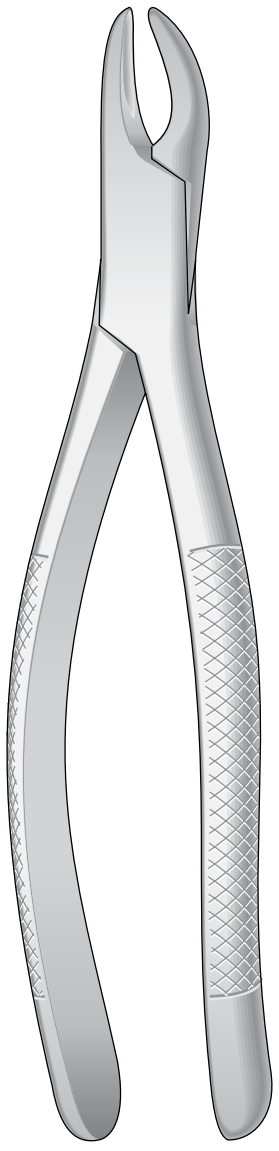
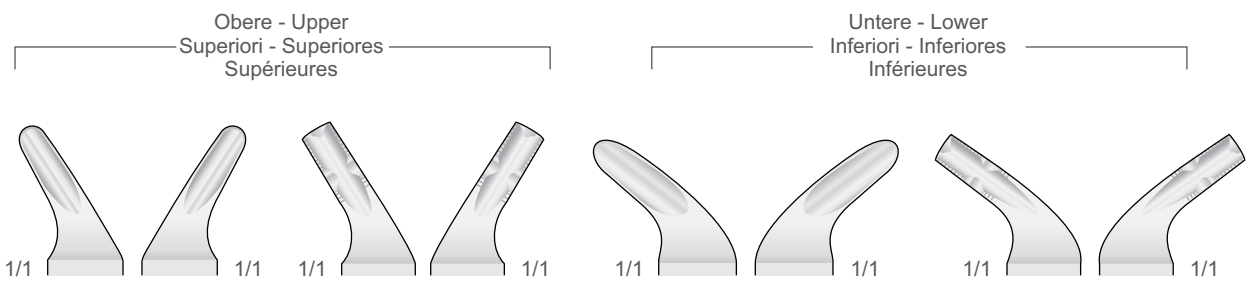
**AM-151X**  
 Fig. 151AS



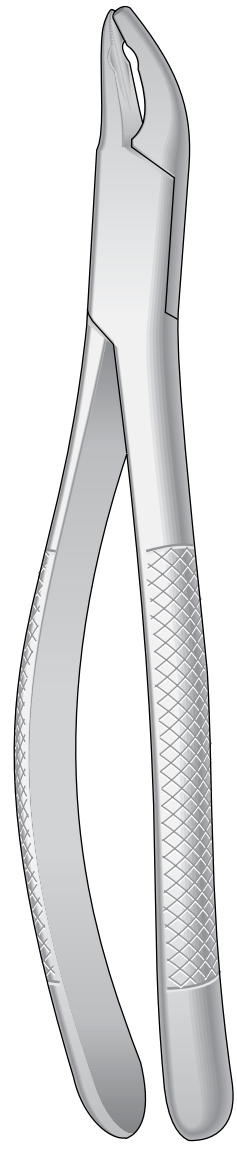


Zahnzangen, Amerikanische Form  
 Extracting Forceps, American Pattern  
 Pinze per estrazione, Forma Americana  
 Pinzas da extracción, Forma Americana  
 Daviers, Forme Américaine

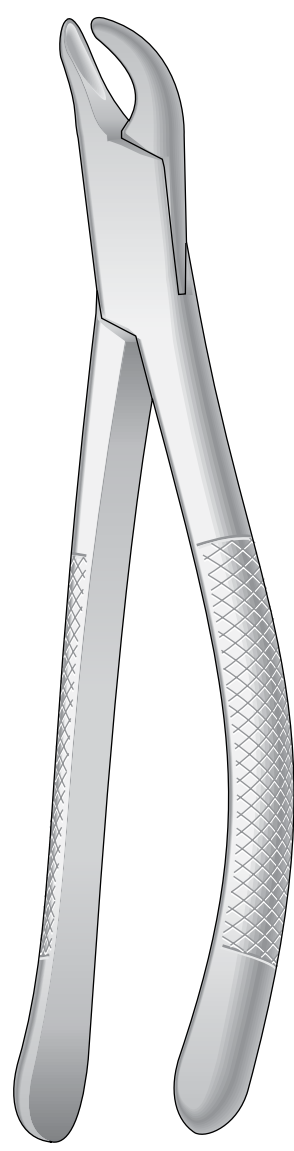
Für Kinder  
 For children  
 Per bambini  
 Para niños  
 Pour enfants



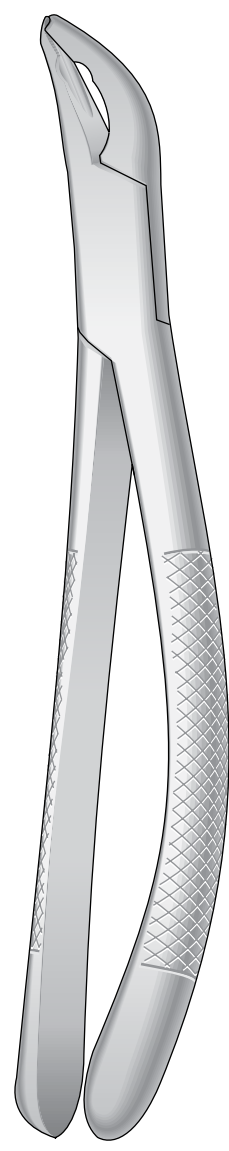
**CRYER  
 AM-150S**  
 Fig.150 S



**AM-150AS**  
 Fig.150 XAS



**CRYER  
 AM-151S**  
 Fig.151 S



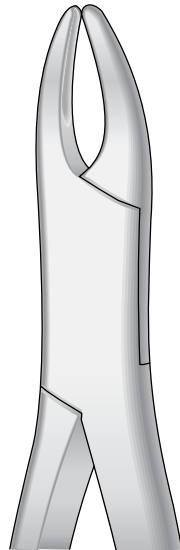
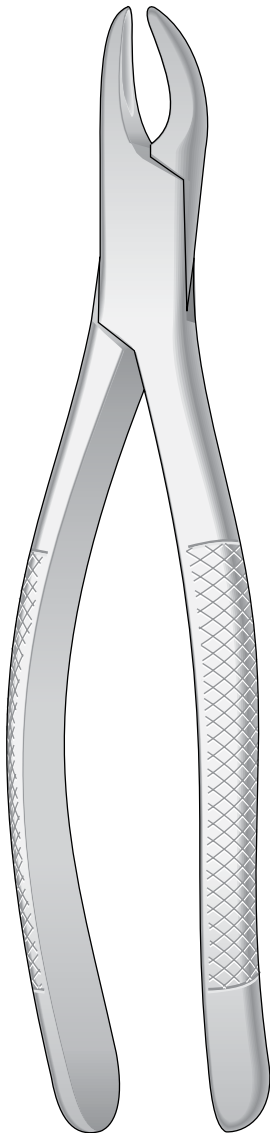
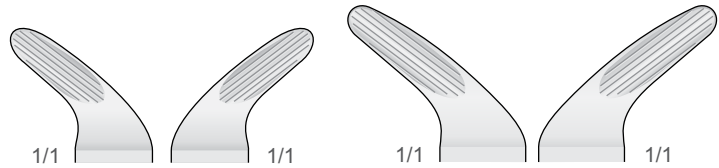
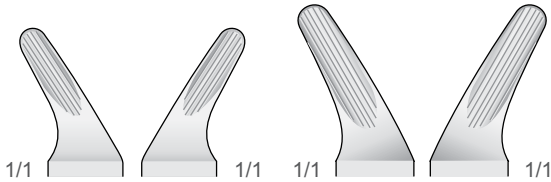
**AM-151AS**  
 Fig.151 XAS



Geriefte - Serrated - Striata - Estriadas - Striées

Obere Schneidezähne, Prämolaren, Wurzeln  
 Upper incisors, premolars, roots  
 Incisivi, premolari e radici superiori  
 Incisivos, premolares y raices superiores  
 Incisives, premolaires et racines supérieures

Untere Schneidezähne, Prämolaren, Wurzeln  
 Lower incisors, premolars, roots  
 Incisivi, premolari e radici inferiori  
 Incisivos, premolares y raices inferiores  
 Incisives, premolaires et racines inférieures

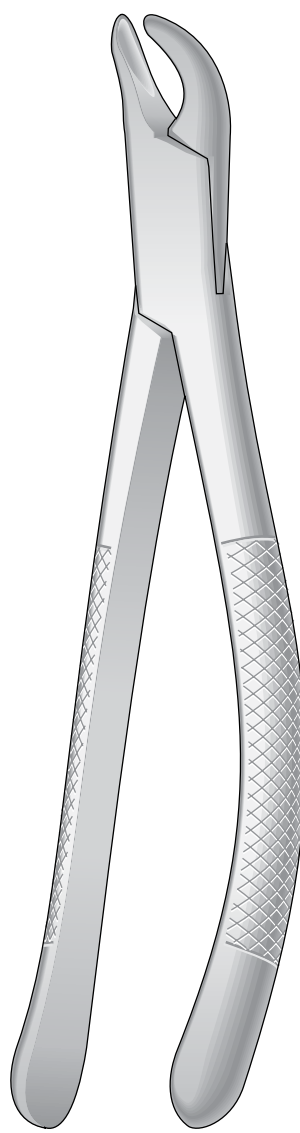


CRYER  
**AMG-150**  
 Fig. 150

Für Erwachsene  
 For adults  
 Per adulti  
 Para adultos  
 Pour adults

Für Kinder  
 For children  
 Per bambini  
 Para niños  
 Pour enfants

CRYER  
**AMG-150S**  
 Fig.150 S



CRYER  
**AMG-151**  
 Fig. 151

Für Erwachsene  
 For adults  
 Per adulti  
 Para adultos  
 Pour adults

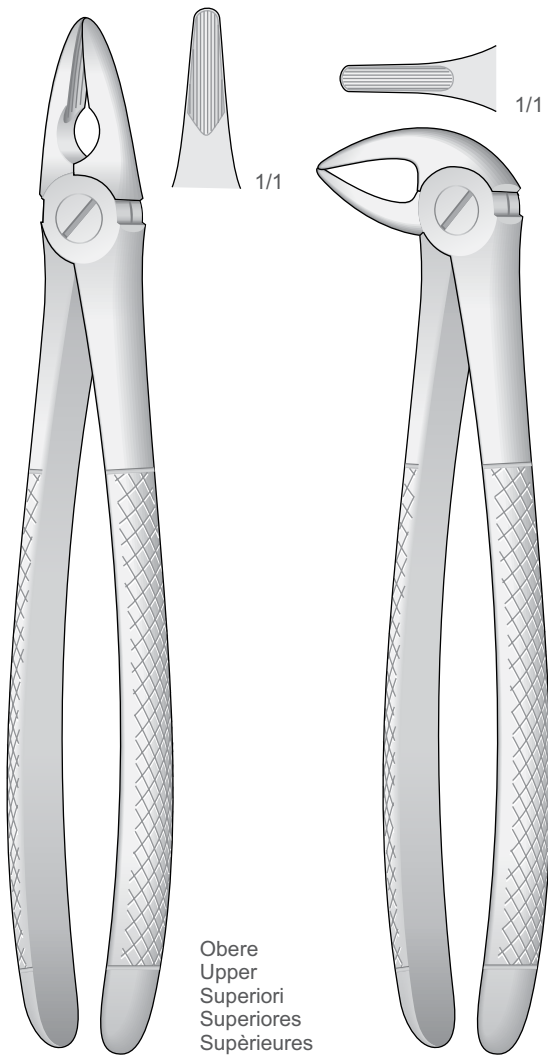
Für Kinder  
 For children  
 Per bambini  
 Para niños  
 Pour enfants

CRYER  
**AMG-151S**  
 Fig.151 S

Zahnzangen  
 Extracting Forceps  
 Pinze per estrazione  
 Pinzas da extracción  
 Daviers

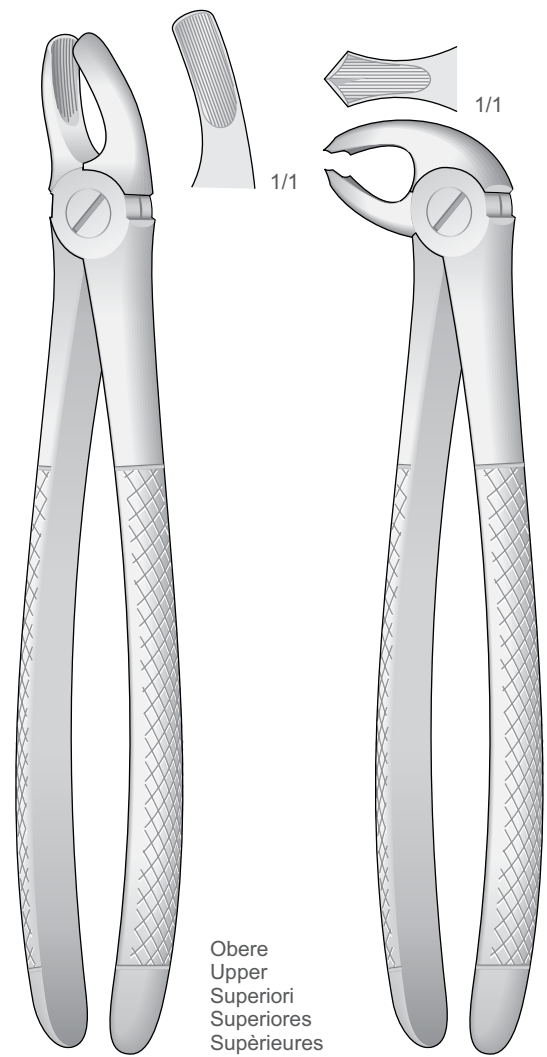
Schneidezähne, Eckzähne, Wurzeln  
 Incisors, bicuspids and roots  
 Incisivi, canini e radici  
 Incisivos, caninos y raíces  
 Incisives, canines et racines

Molaren  
 Molars  
 Molari  
 Molares  
 Molaires



Obere  
 Upper  
 Superiori  
 Supérieures

Untere  
 Lower  
 Inferiori  
 Inférieures



Obere  
 Upper  
 Superiori  
 Supérieures

Untere  
 Lower  
 Inferiori  
 Inférieures

MEAD  
 MD-1

MEAD  
 MD-3

MEAD  
 MD-2

MEAD  
 MD-4



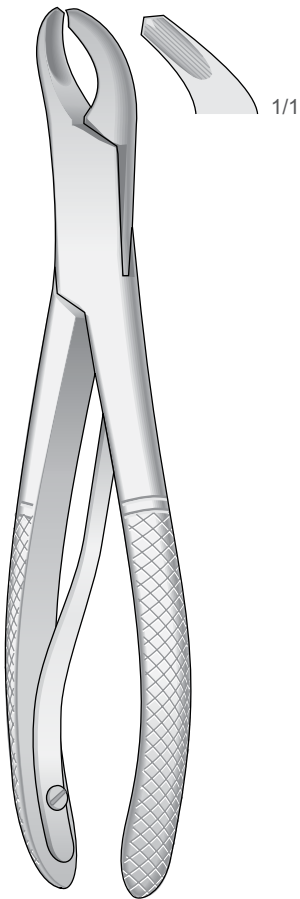
Kinderzahnzangen, Amerikanische Form  
 Extracting Forceps for children, American Pattern  
 Pinze per estrazione per bambini, Forma Americana  
 Forceps dentales para niños, Forma Americana  
 Daviers pour enfants, Forme Américaine

Molaren  
 Pedo Lower Molars  
 Molari  
 Molares  
 Molaires

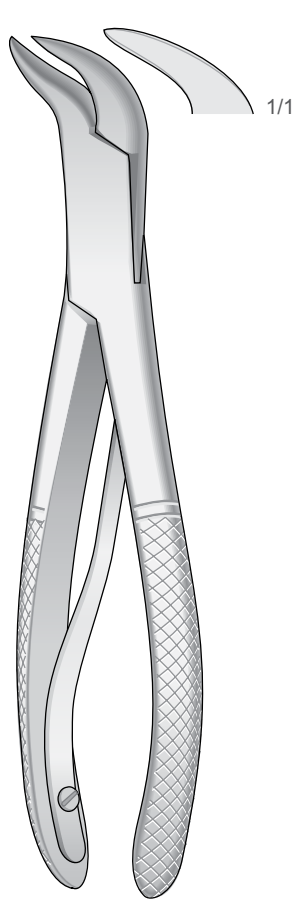
Molaren  
 Pedo Lower Molars  
 Molari  
 Molares  
 Molaires

Zähne und wurzeln  
 Pedo upper incisors  
 Bicuspid and roots  
 Denti e radici  
 Dientes y raíces  
 Dentes et racines

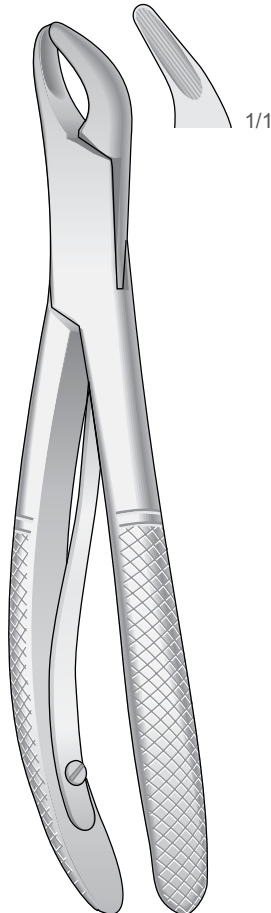
Zähne und wurzeln  
 Pedo lower incisors  
 Bicuspid and roots  
 Denti e radici  
 Dientes y raíces  
 Dentes et racines



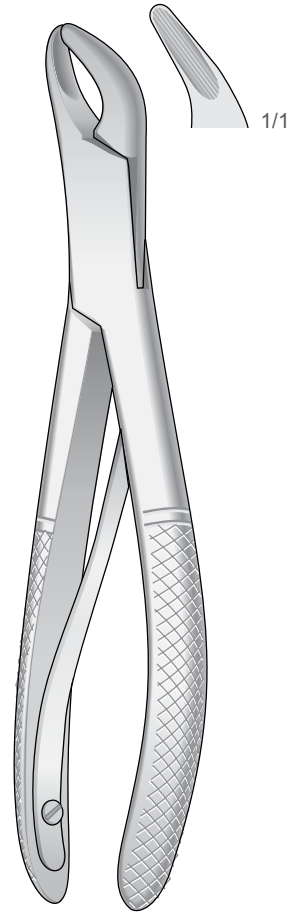
**PEB-17S**  
 Fig. 17SK



**PEB-23S**  
 Fig. 23SK



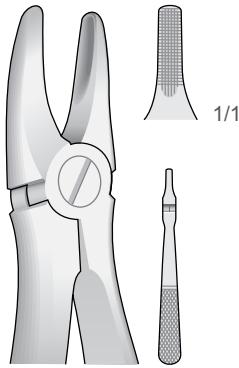
**PEB-150S**  
 Fig. 150SK



**PEB-151S**  
 Fig. 151SK

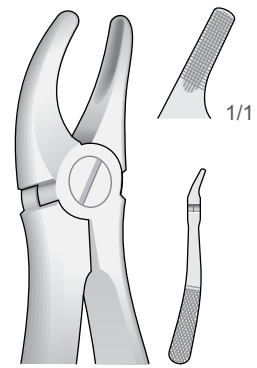


Kinderzahnzangen  
 Extracting Forceps for children  
 Pinze per estrazione per bambini  
 Forceps dentales para niños  
 Daviers pour enfants



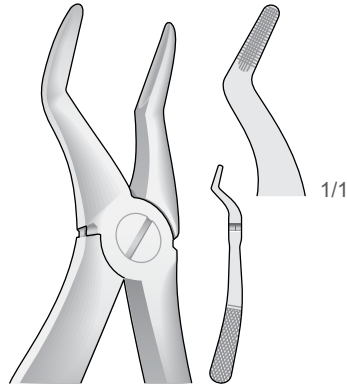
**PEB-1**  
 Fig. 137

Obere Schneidezähne  
 Upper Incisors  
 Incisivi superiori  
 Incisivos superiores  
 Incisives supérieures



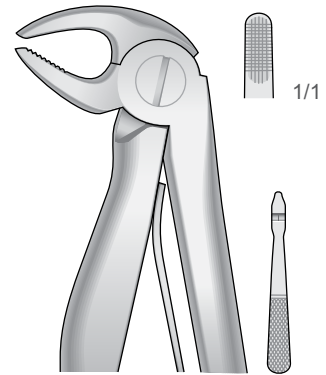
**PEB-2**  
 Fig. 139

Obere Prämolaren  
 Upper Premolars  
 Premolari superiori  
 Premolares superiores  
 Prémolaires supérieures



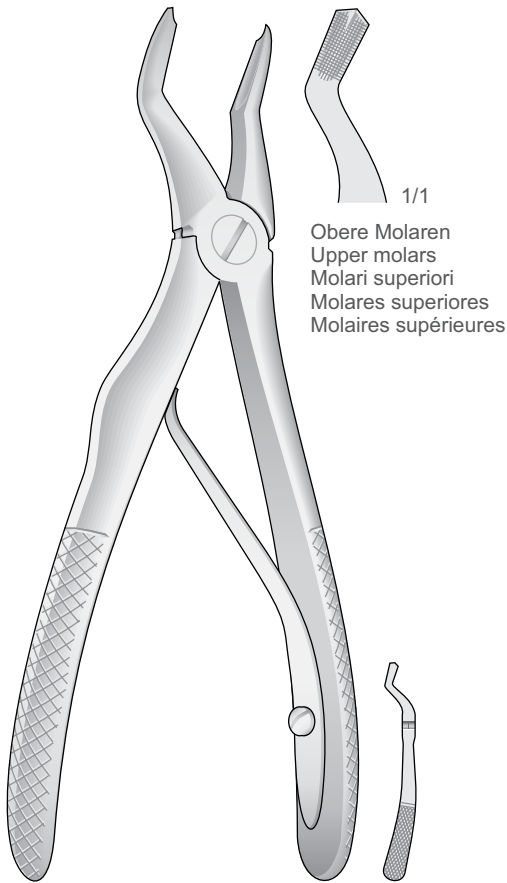
**PEB-4**  
 Fig. 51S

Obere Wurzeln  
 Upper roots  
 Radici superiori  
 Raíces superiores  
 Racines supérieures



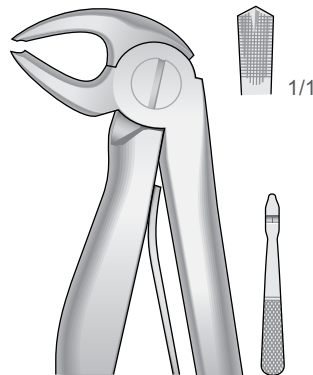
**PEB-5**  
 Fig. 5

Untere Schneidezähne  
 Lower incisors  
 Incisivi inferiori  
 Incisivos inferiores  
 Incisives inférieures



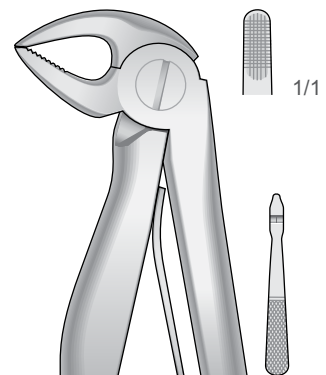
**PEB-3**

Obere Molaren  
 Upper molars  
 Molari superiori  
 Molares superiores  
 Molaires supérieures



**PEB-6**  
 Fig. 6

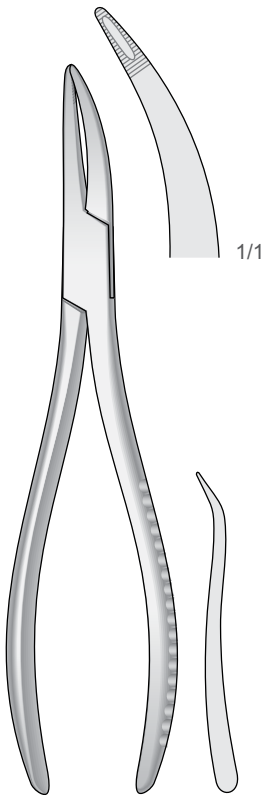
Untere Molaren  
 Lower Molars  
 Molari inferiori  
 Molares inferiores  
 Molaires inférieures



**PEB-7**  
 Fig. 7

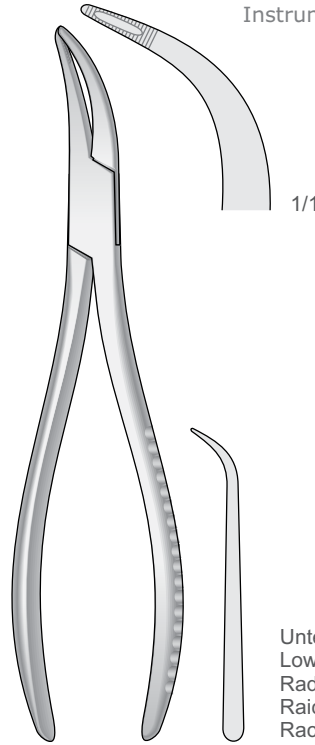
Untere Wurzeln  
 Lower roots  
 Radici inferiori  
 Raíces inferiores  
 Racines inférieures

Wurzelfragmentinstrumente  
 Root Fragment Forceps  
 Strumenti per frammenti di radici  
 Instrumentos para fragmentos de raíces  
 Instruments pour fragments de racines



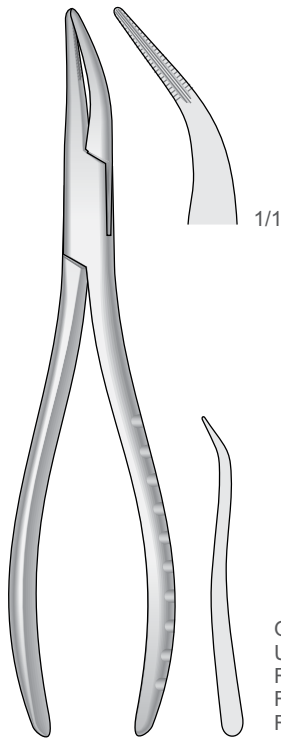
Obere Wurzeln, Universal  
 Upper roots, Universal  
 Radici superiori, Universale  
 Raíces superiores, Universal  
 Racines superieures, Universel

**WITZEL  
 DK-26**  
 170 mm



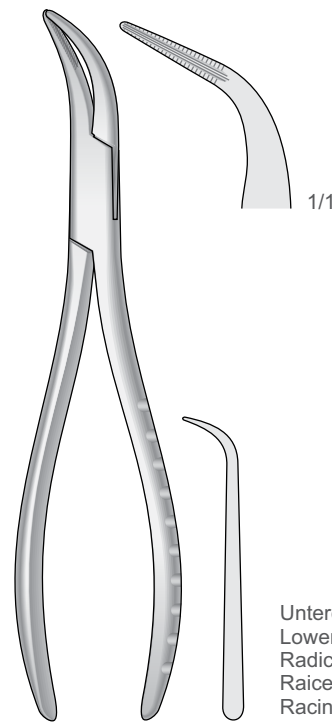
Untere Wurzeln, Universal  
 Lower roots, Universal  
 Radici inferiori, Universale  
 Raíces inferiores, Universal  
 Racines inferieures, Universel

**WITZEL  
 DK-28**  
 165 mm



Obere Wurzeln, Universal  
 Upper roots, Universal  
 Radici superiori, Universale  
 Raíces superiores, Universal  
 Racines superieures, Universel

**S-400**  
 # 400 (300)  
 165 mm

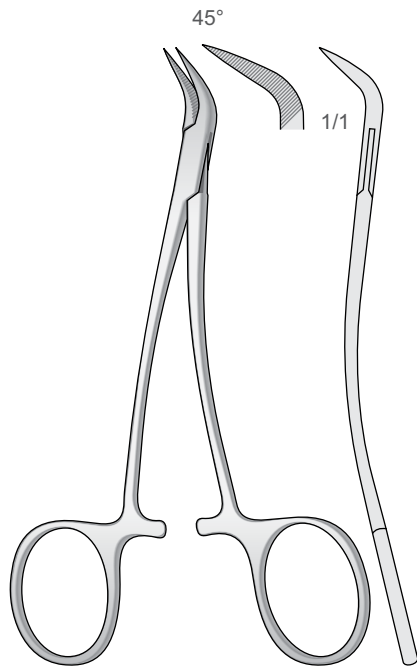


Untere Wurzeln, Universal  
 Lower roots, Universal  
 Radici inferiori, Universale  
 Raíces inferiores, Universal  
 Racines inferieures, Universel

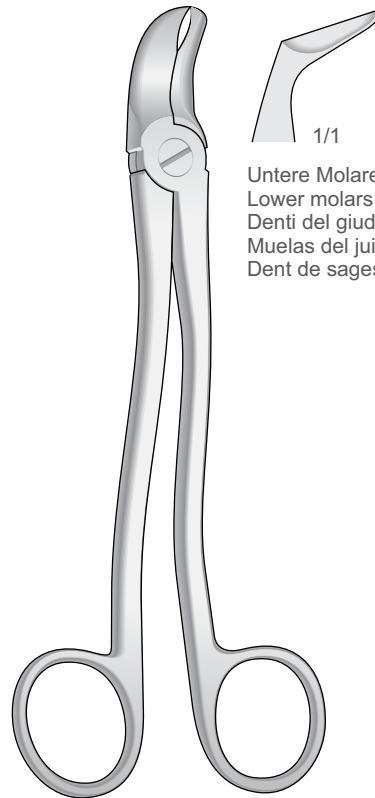
**I-401**  
 # 401 (301)  
 160 mm



Wurzelfragmentinstrumente  
 Root Fragment Forceps  
 Strumenti per frammenti di radici  
 Instrumentos para fragmentos de raíces  
 Instruments pour fragments de racines



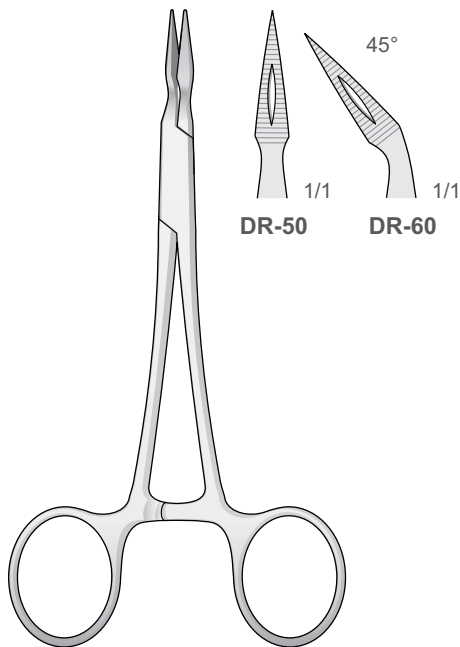
PEET  
**DR-40**  
 120 mm



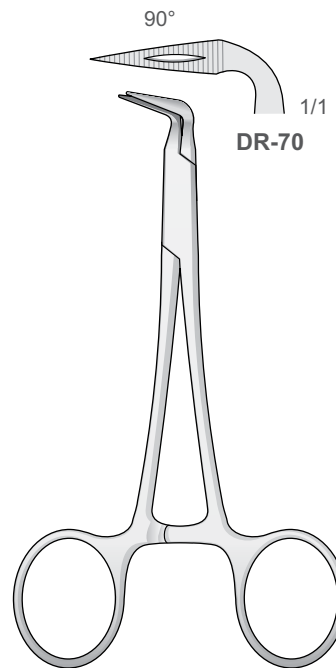
Untere Molaren und Weisheitszähne  
 Lower molars and wisdom teeth  
 Denti del giudizio e molari inferiori  
 Muelas del juicio y molares inferiores  
 Dent de sagesse et molaires inférieures

**RO-1**  
 175 mm

Wurzelfragmente  
 Root fragments  
 Frammenti di radici  
 Fragmentos de raíces  
 Fragments de racines

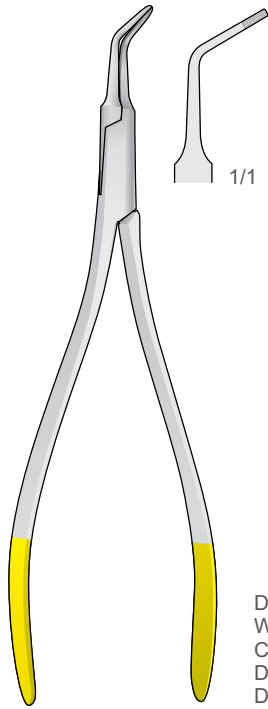


STIEGLITZ  
**DR-50/DR-60**  
 140 mm



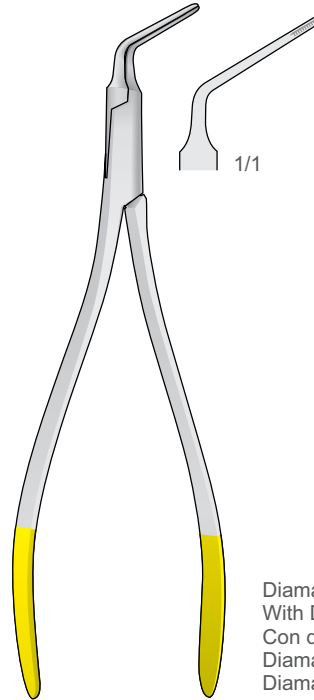
STIEGLITZ  
**DR-70**  
 120 mm

Wurzelfragmentinstrumente  
 Root Fragment Forceps  
 Strumenti per frammenti di radici  
 Instrumentos para fragmentos de raíces  
 Instruments pour fragments de racines



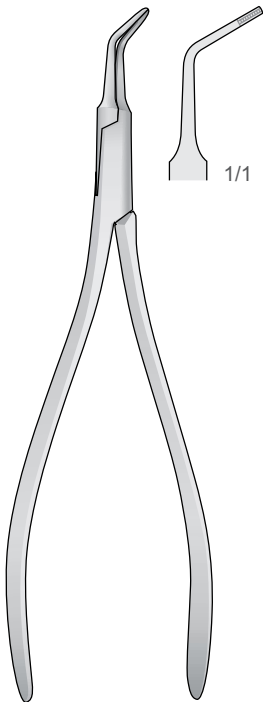
**DA-01M**  
130 mm

Diamantiert  
 With Diamond  
 Con diamante  
 Diamantada  
 Diamantées

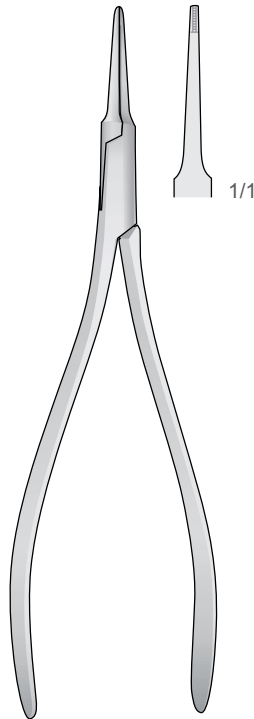


**DA-10**  
130 mm

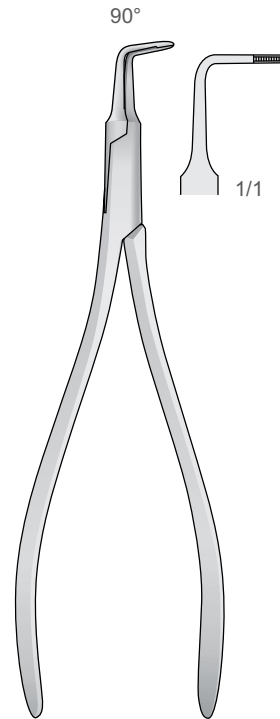
Diamantiert  
 With Diamond  
 Con diamante  
 Diamantada  
 Diamantées



**DA-01**  
130 mm



**DA-02**  
130 mm



**DA-03**  
125 mm







we take a closer look

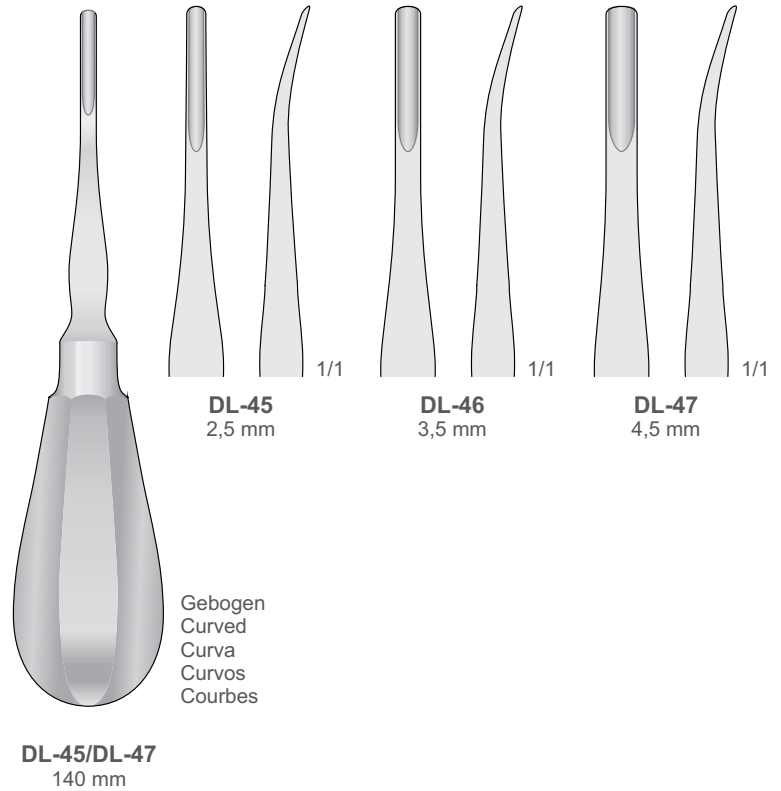
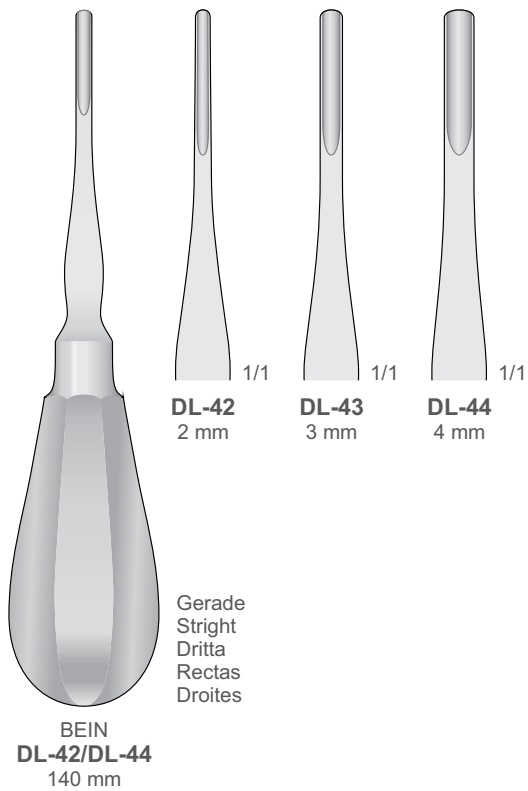
# + ELEVATORS



| Roots & Luxating Elevators

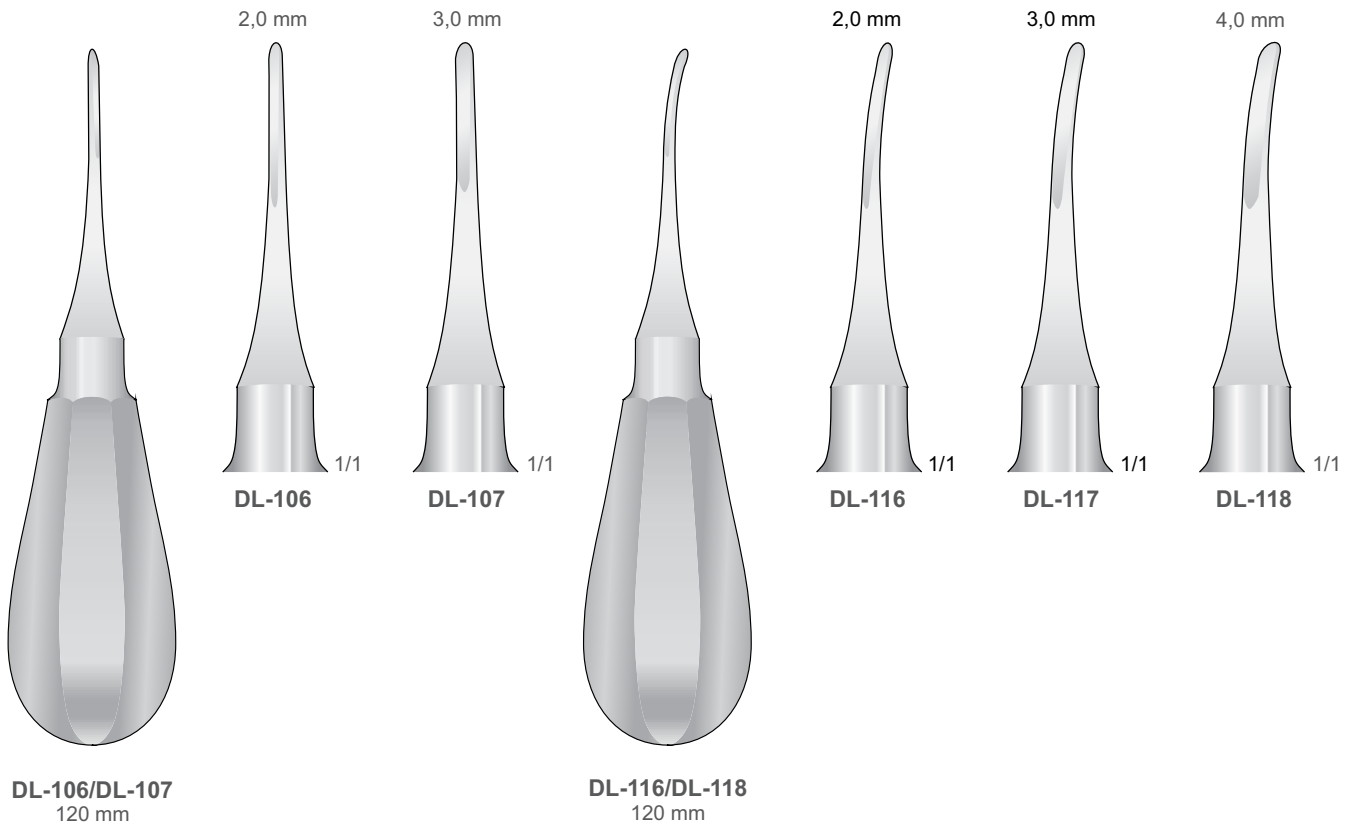


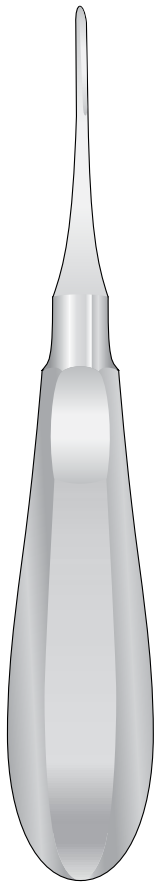
Wurzelheber  
 Root Elevators  
 Leve per radici  
 Elevadores para raíces  
 Elevateurs à racines



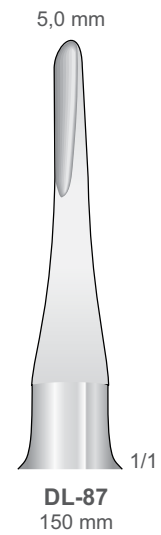
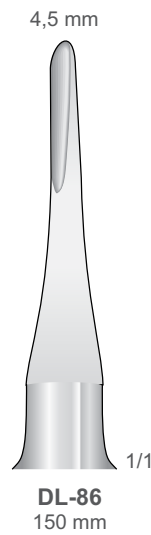
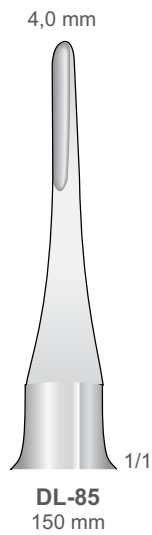
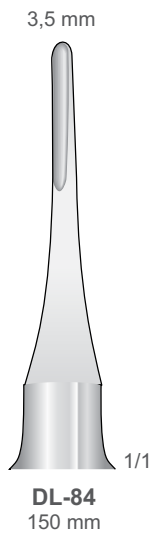
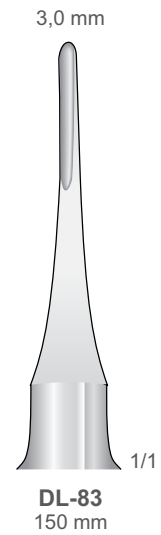
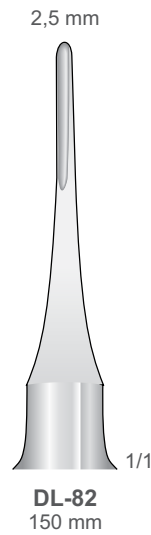
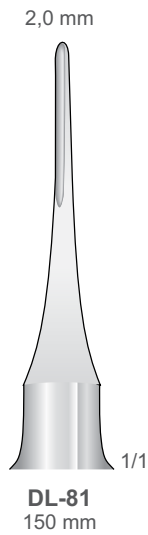
SMALL HANDLE

Luxierinstrumente | Luxating Elevators | Elevatori di lussazione | Elevadores de luxación | Élévateurs de luxation

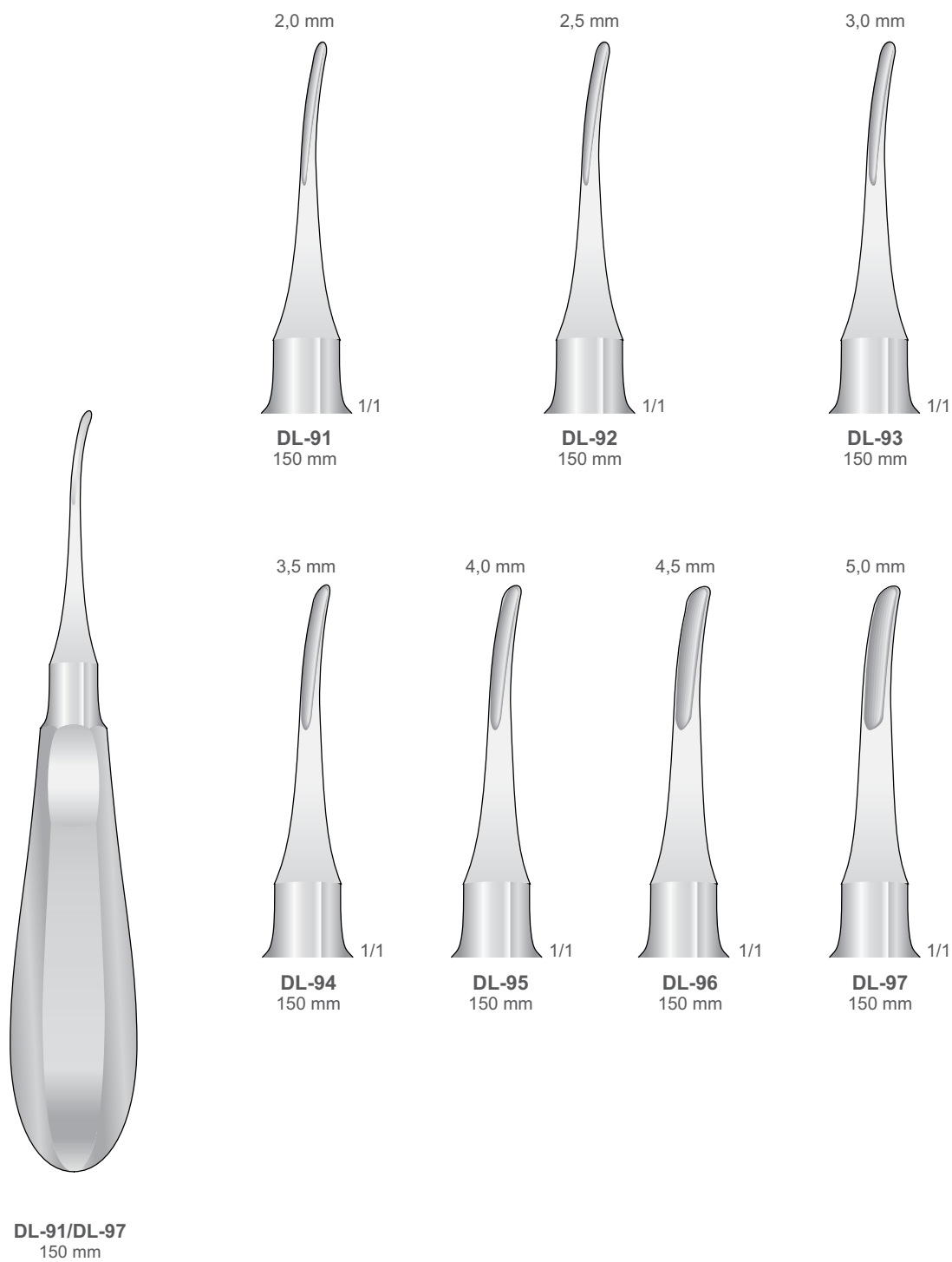




**DL-81/DL-87**  
150 mm

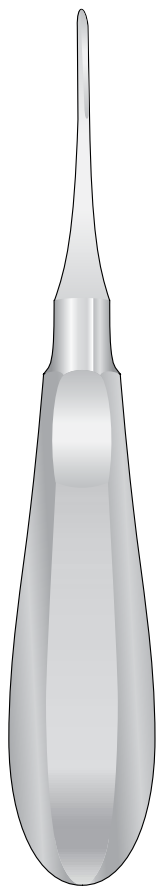
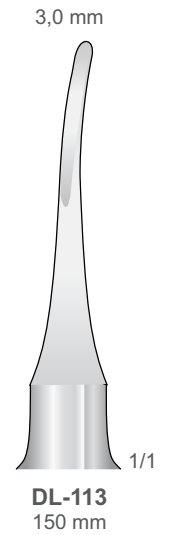
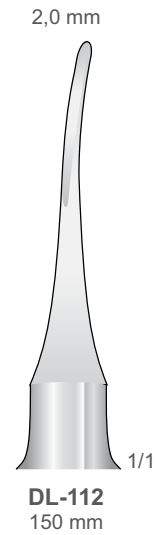
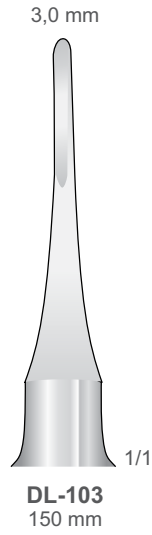
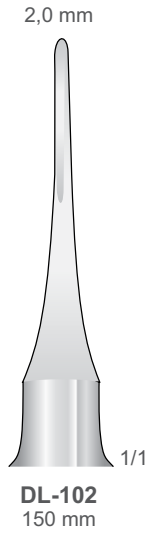


Wurzelheber  
Root Elevators  
Leve per radici  
Elevadores para raíces  
Elevateurs à racines

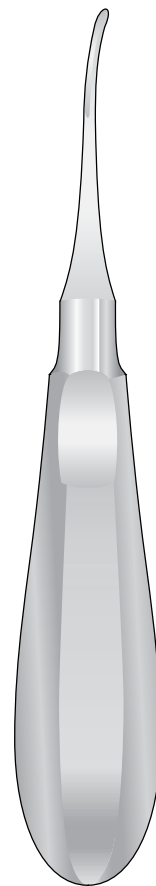
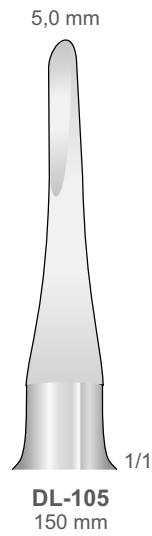
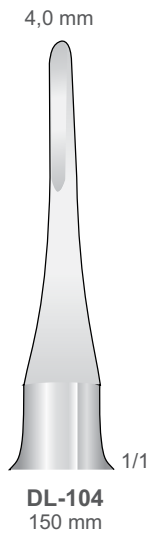


**SMALL HANDLE**

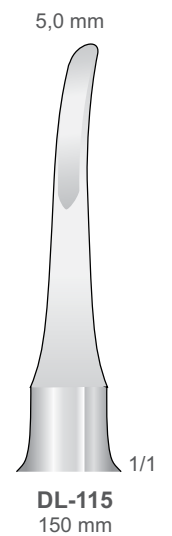
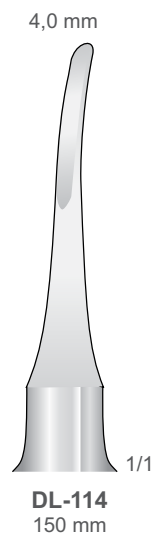
Luxierinstrumente | Luxating Elevators | Elevatori di lussazione | Elevadores de luxación | Élévateurs de luxation



**DL-102/DL-105**  
150 mm



**DL-112/DL-115**  
150 mm

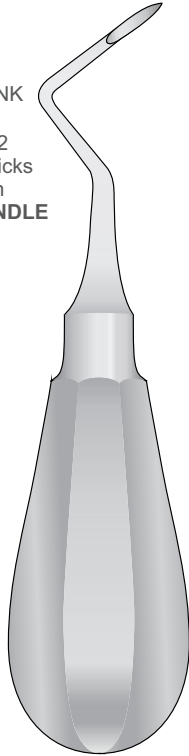


Wurzelheber  
 Root Elevators  
 Leve per radici  
 Elevadores para raíces  
 Elevateurs à racines

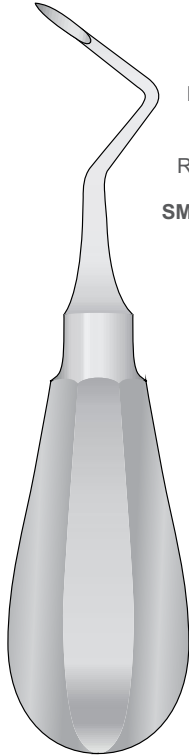
Wurzelspitzenheber  
 Root fragment Elevators  
 Leve per frammenti di radice  
 Elevadores para fragmentos de raíces  
 Elévateurs de fragments de racines

**ELEVATORS**

HEIDBRINK  
**HE-2S**  
 Right # 2  
 Root Tip Picks  
 140 mm  
**SMALL HANDLE**



HEIDBRINK  
**HE-3S**  
 Left # 3  
 Root Tip Picks  
 140 mm  
**SMALL HANDLE**



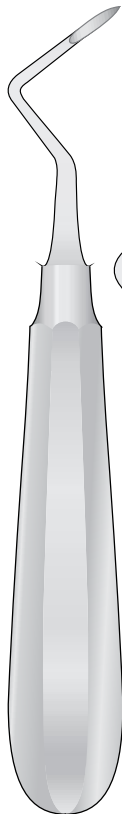
Gezähnt  
 Serrated  
 Dentellata  
 Dentada  
 Dentelé



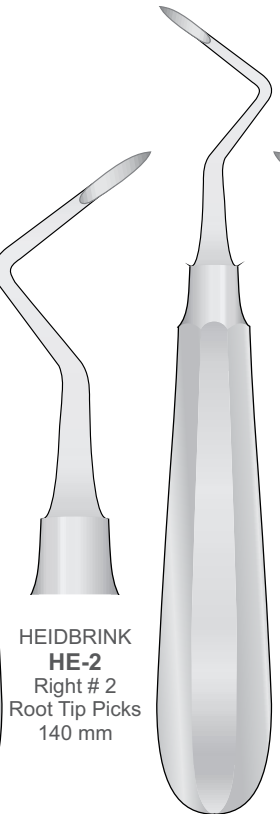
HEIDBRINK  
**HE-1**  
 Straight # 1  
 Root Tip Picks  
 140 mm



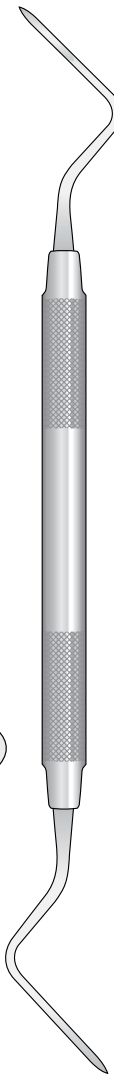
HEIDBRINK  
**HE-2**  
 Right # 2  
 Root Tip Picks  
 140 mm



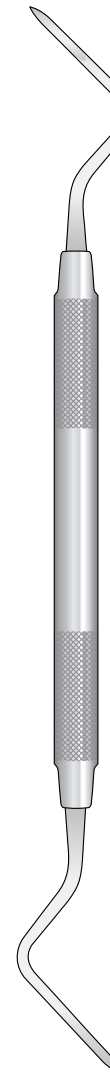
HEIDBRINK  
**HE-3**  
 Left # 3  
 Root Tip Picks  
 140 mm



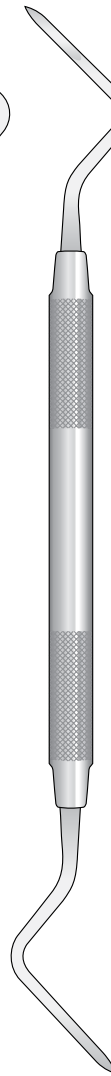
HEIDBRINK  
**725-1/2**  
 195 mm



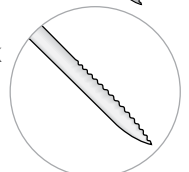
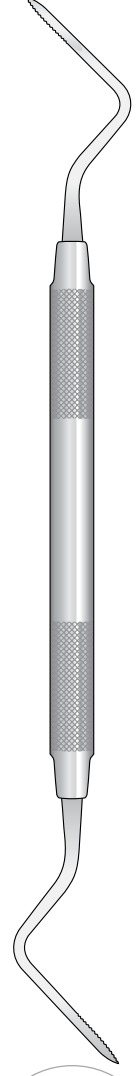
HEIDBRINK  
**725-3/4**  
 195 mm



HEIDBRINK  
**725-5/6**  
 195 mm



HEIDBRINK  
**725-3/4S**  
 195 mm

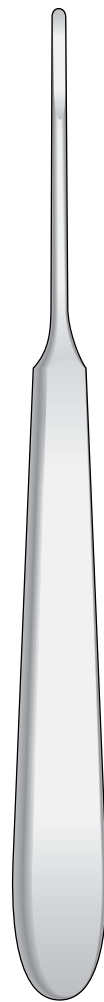


Extraktionshebel für obere Weisheitszähne  
 Root Elevator for upper wisdom teeth  
 Leva per estrazione dente del giudizio superiore  
 Elevador de extracción de muelas del juicio superiores  
 Élévateur à racines pour les dents de sagesse supérieures

Wurzelheber  
 Root Elevators  
 Leve per radici  
 Elevadores para raíces  
 Élevateurs de racines



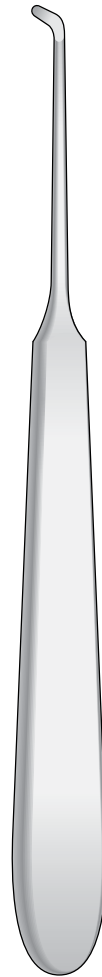
ROSIN  
**DL-58**  
 160 mm



WARWICK-JAMES  
**DL-20**  
 160 mm



WARWICK-JAMES  
**DL-21**  
 155 mm



WARWICK-JAMES  
**DL-22**  
 155 mm

Obere  
 Upper  
 Superiori  
 Supérieures

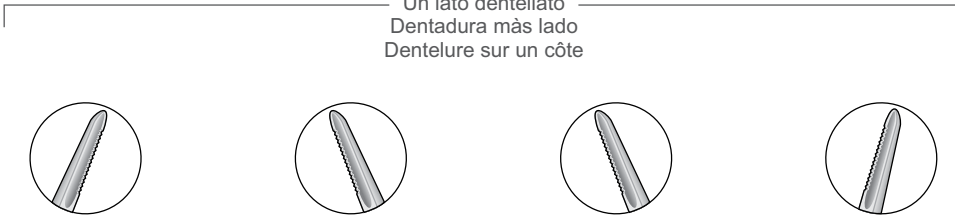
Untere  
 Lower  
 Inferiori  
 Inférieures

Untere  
 Lower  
 Inferiori  
 Inférieures



Wurzelheber  
 Root Elevators  
 Leve per radici  
 Elevadores para raíces  
 Elevateurs à racines

Eine seite gezahnt  
 One side serrated  
 Un lato dentellato  
 Dentadura mäs lado  
 Dentelure sur un côté



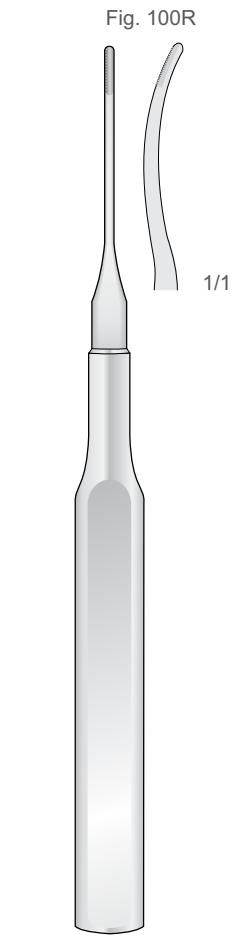
**DL-76**  
155 mm



**DL-77**  
155 mm



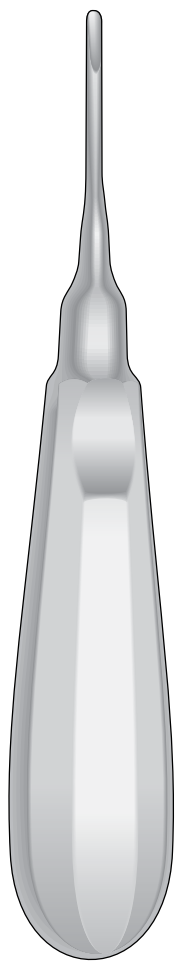
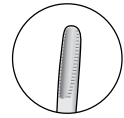
**DL-78**  
155 mm



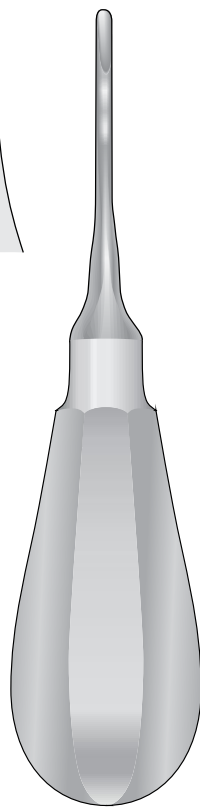
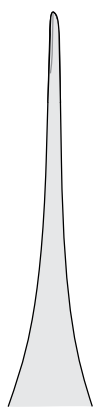
**DL-79**  
155 mm



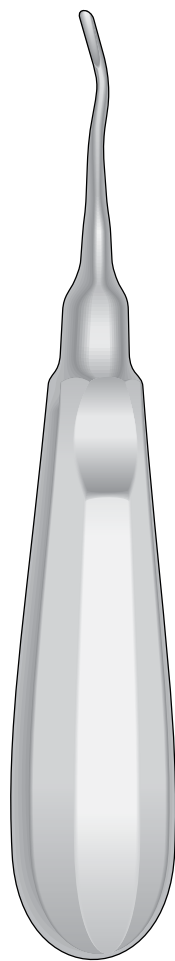
Gezahnt  
 Serrated  
 Dentellate  
 Dentadas  
 Dentelé



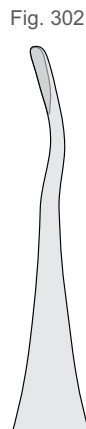
APEXO  
**DL-34S**  
 # 301  
 155 mm



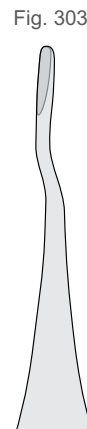
APEXO  
**DL-34S**  
 # 301  
 130 mm  
**SMALL HANDLE**



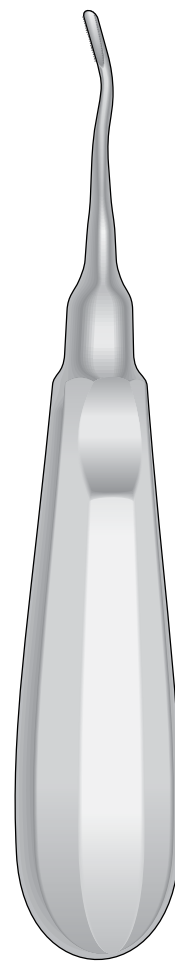
APEXO  
**DL-35/DL-36**  
 155 mm



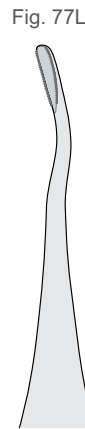
DL-35



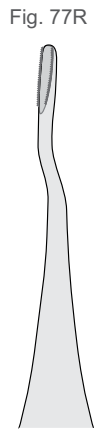
DL-36



APEXO  
**DL-37/DL-38**  
 155 mm

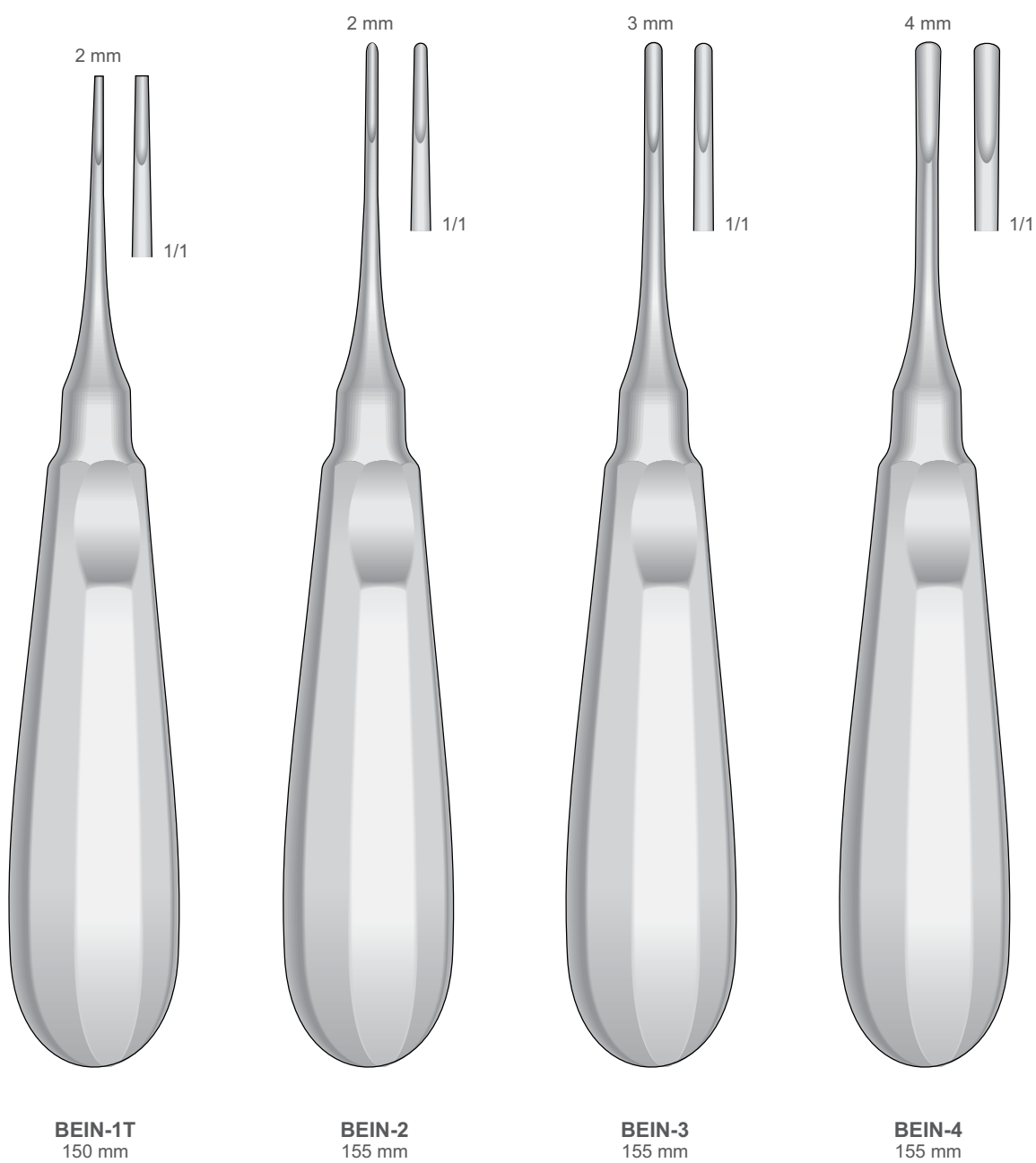


DL-37



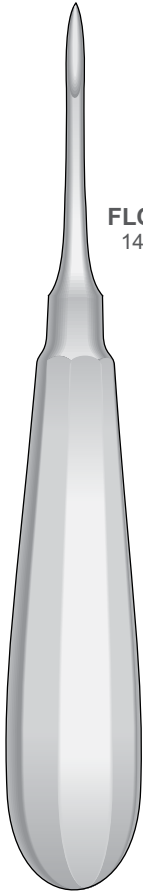
DL-38

Wurzelheber  
Root Elevators  
Leve per radici  
Elevadores para raíces  
Elevateurs à racines

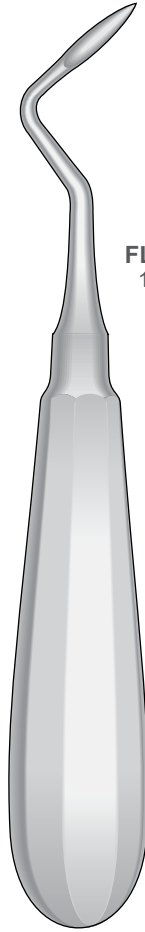


Wurzelheber  
Root Elevators  
Leve per radici  
Elevadores para raíces  
Elevateurs à racines

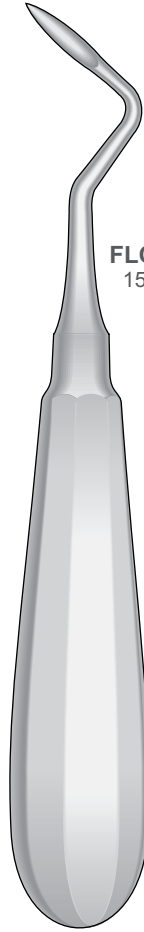
**FLOHR-1**  
140 mm



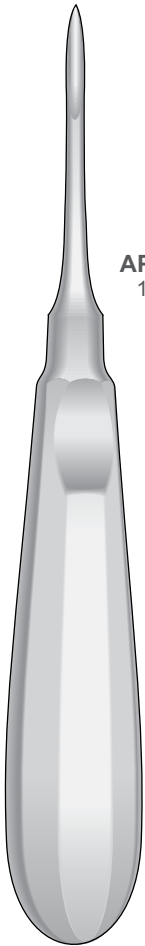
**FLOHR-2**  
150 mm



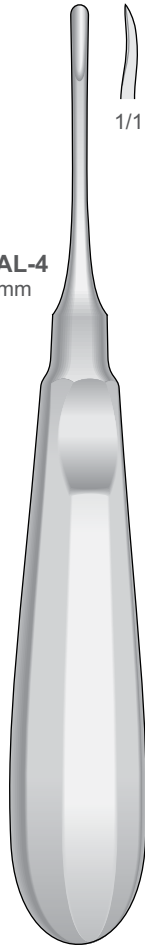
**FLOHR-3**  
150 mm



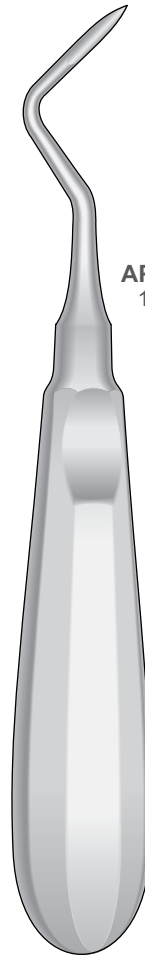
**APICAL-1**  
155 mm



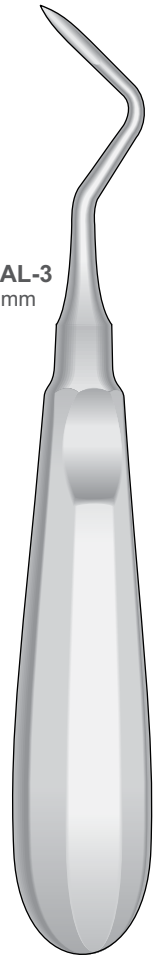
**APICAL-4**  
155 mm



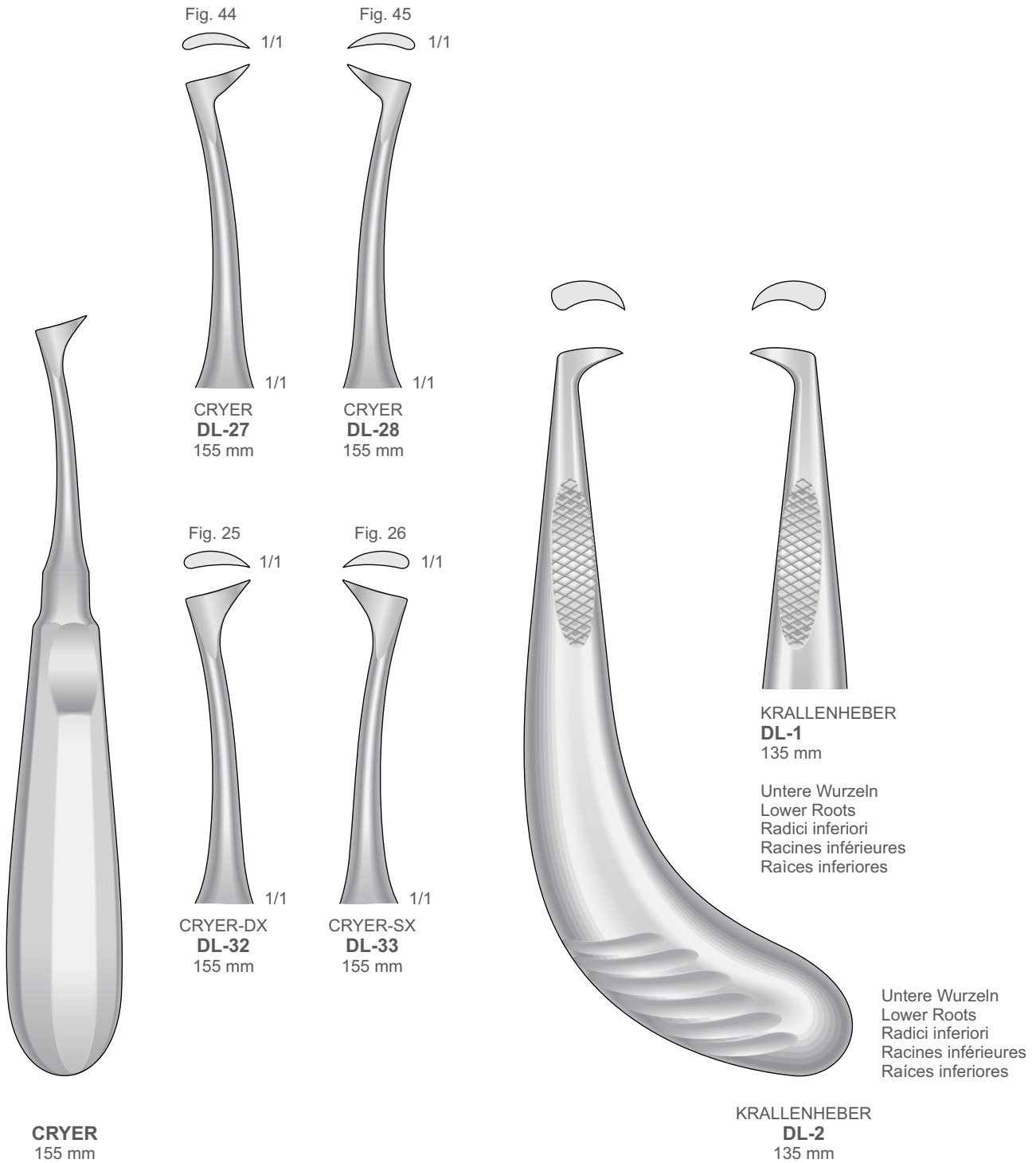
**APICAL-2**  
155 mm



**APICAL-3**  
155 mm



Wurzelheber  
 Root Elevators  
 Leve per radici  
 Elevadores para raíces  
 Elevateurs à racines



**ELEVATORS**

Wurzelheber  
 Root Elevators  
 Leve per radici  
 Elevadores para raíces  
 Elevateurs à racines



**MIR-20**  
 Large  
 160 mm  
 Angled IN



**MIR-24**  
 Large  
 160 mm  
 Angled OUT



**MIR-23**  
 Small  
 160 mm  
 Angled IN



**MIR-21**  
 Small  
 160 mm  
 Angled OUT



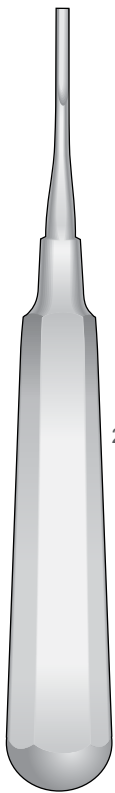
**MIR-22**  
 Straight  
 160 mm



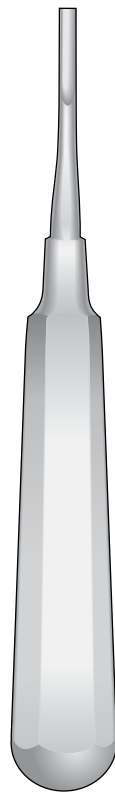
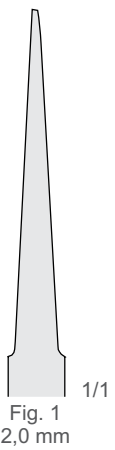
**MIR-25**  
 Bayonet  
 160 mm



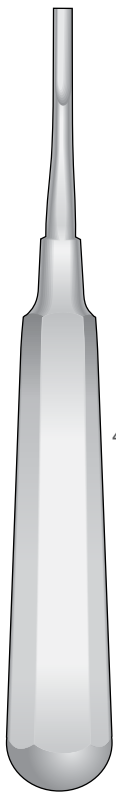
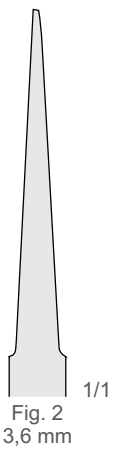
**MIR-26**  
 Curved  
 160 mm



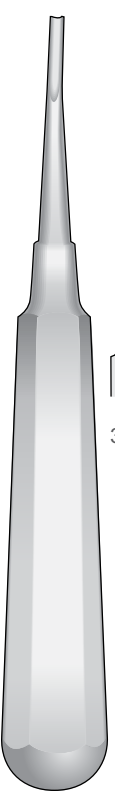
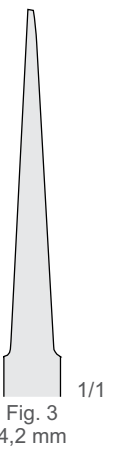
**COUPLAND CO-1**  
 155 mm



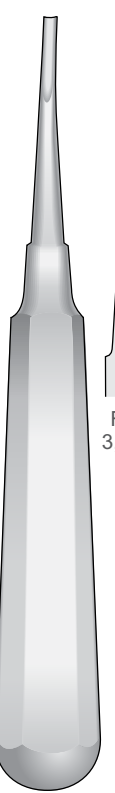
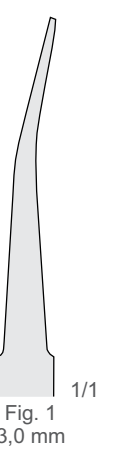
**COUPLAND CO-2**  
 155 mm



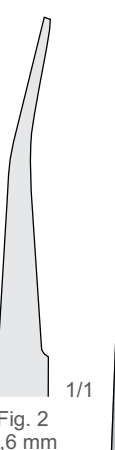
**COUPLAND CO-3**  
 155 mm



**COUPLAND CO-11**  
 155 mm



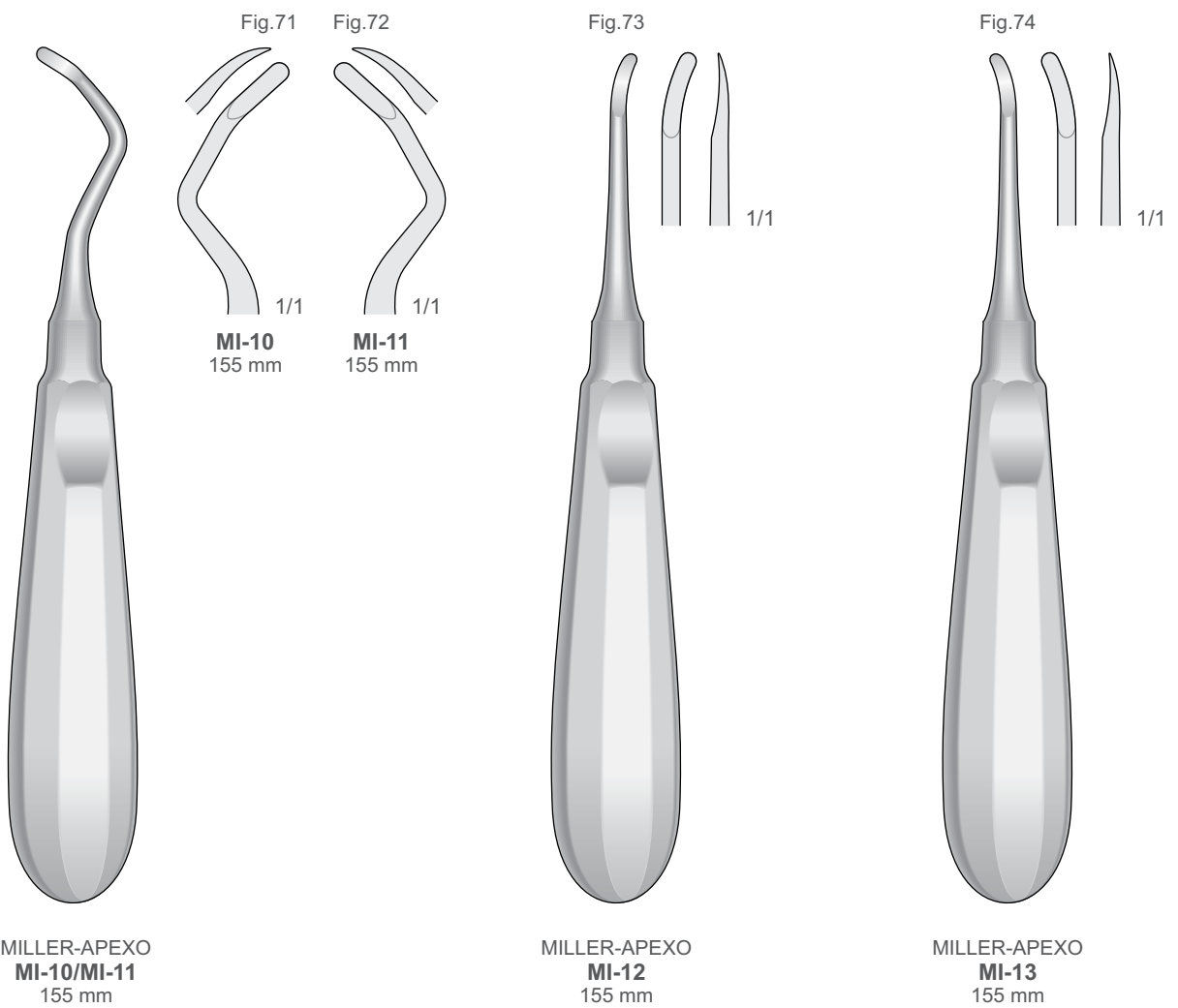
**COUPLAND CO-12**  
 155 mm

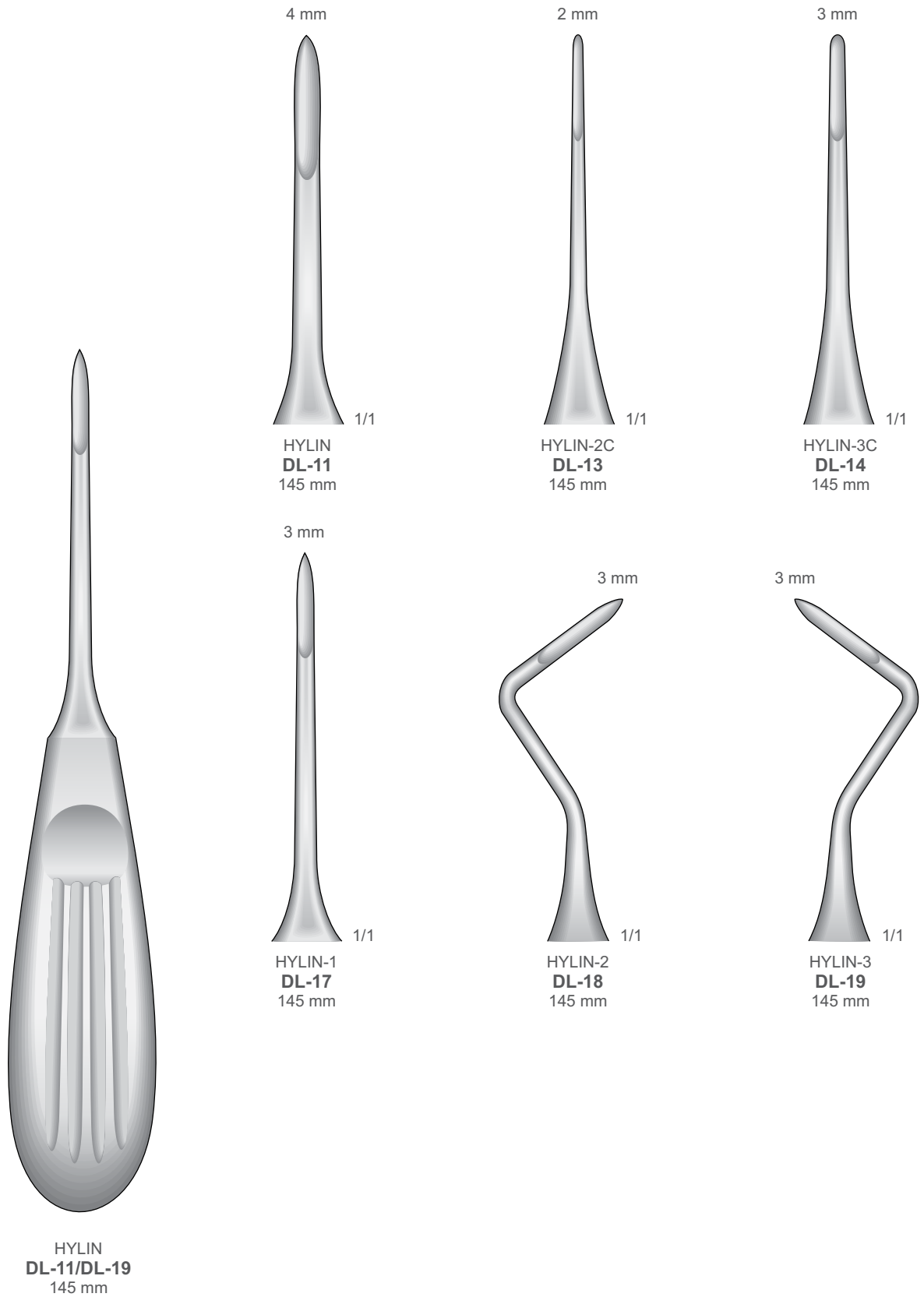


**COUPLAND CO-13**  
 155 mm



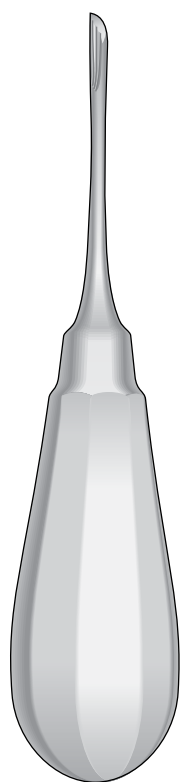
Wurzelheber  
Root Elevators  
Leve per radici  
Elevadores para raíces  
Elevateurs à racines



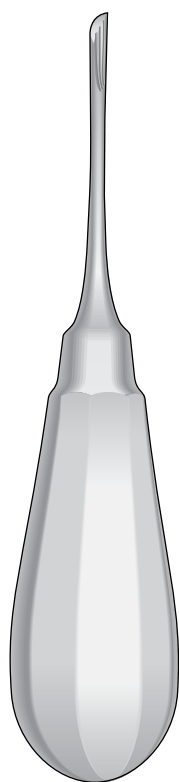




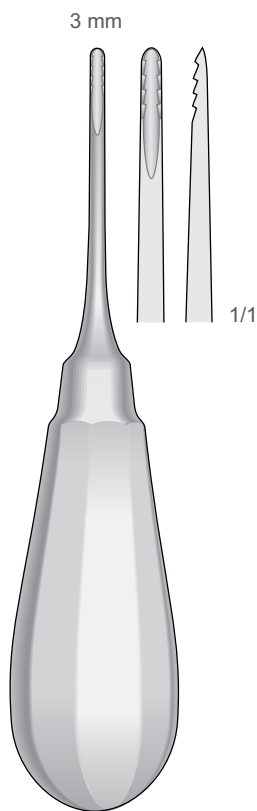
Wurzelheber  
Root Elevators  
Leve per radici  
Elevadores para raíces  
Elevateurs à racines



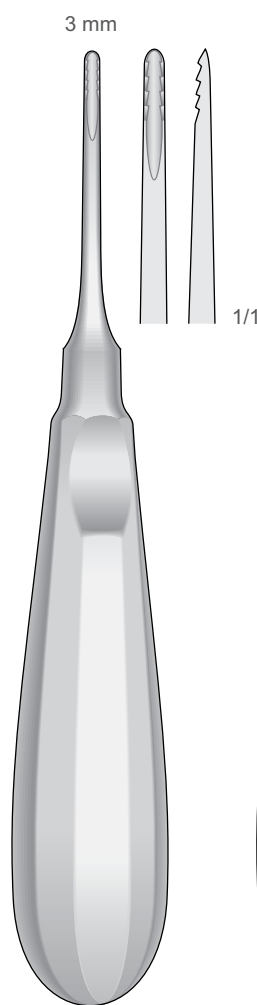
**KOPP  
DL-30**  
130 mm



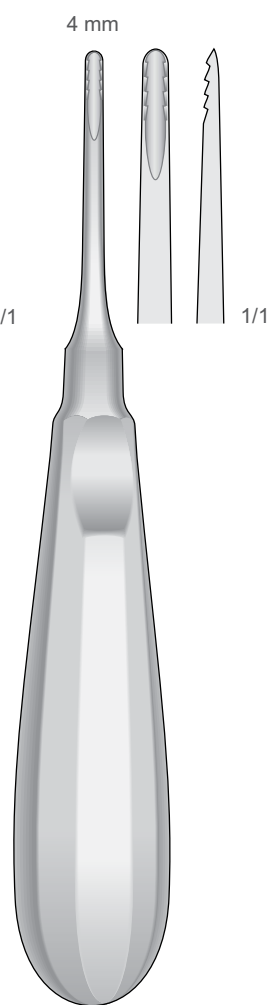
**KOPP  
DL-31**  
130 mm



**BEIN-1Z**  
130 mm

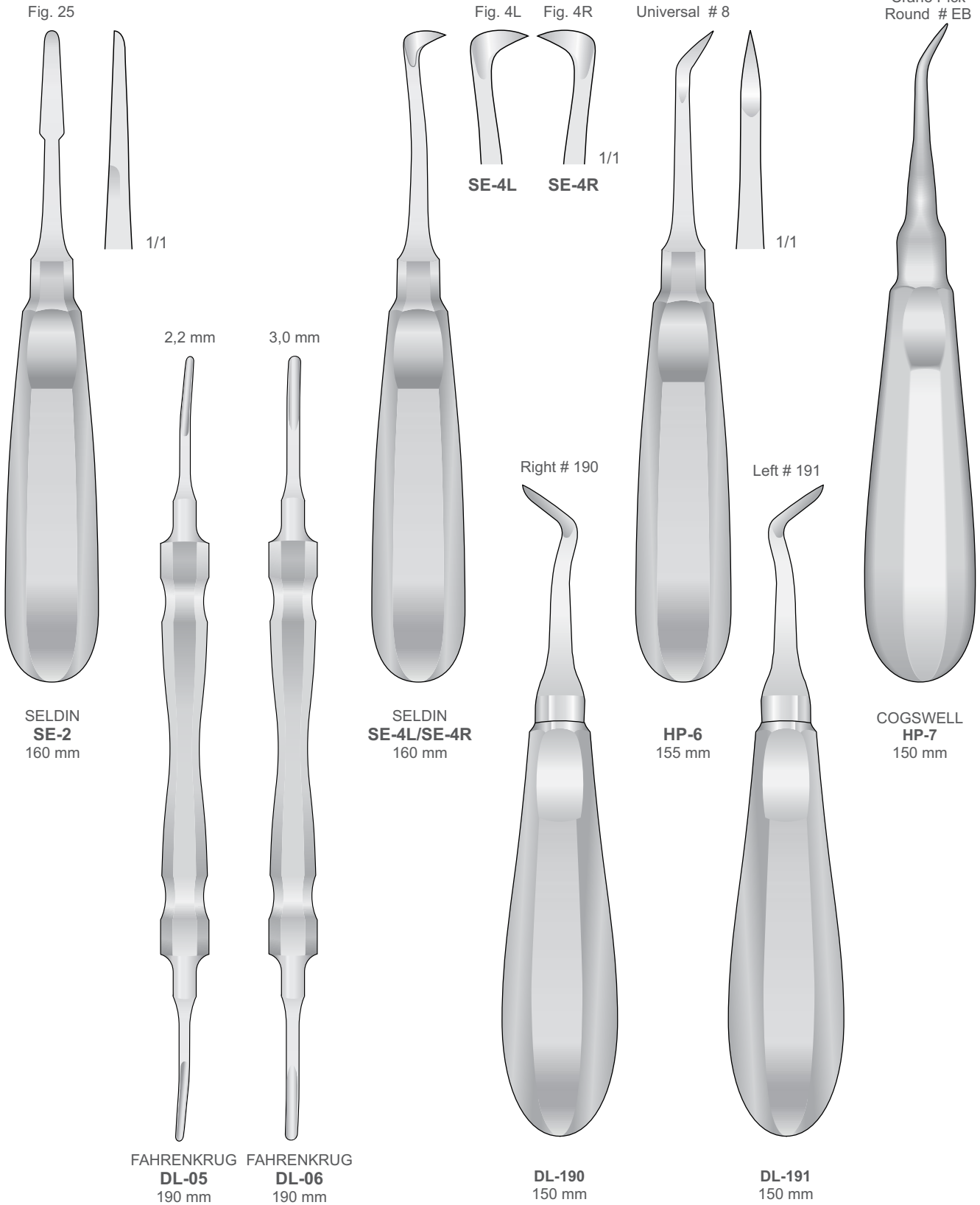


**BEIN-2Z**  
155 mm



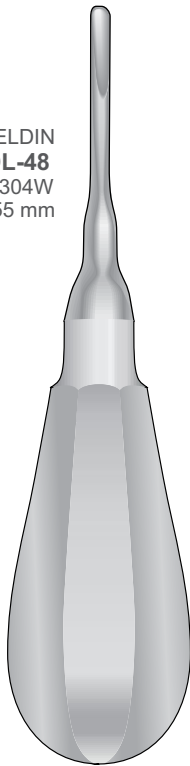
**LINDO-LEVIEN  
BEIN-4Z**  
155 mm



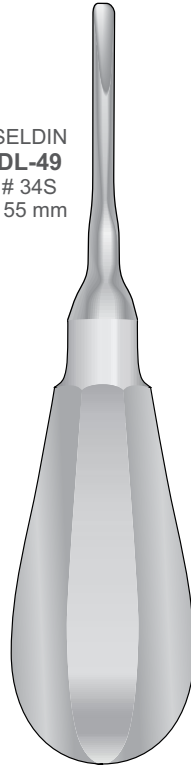


Wurzelheber  
Root Elevators  
Leve per radici  
Elevadores para raíces  
Elevateurs à racines

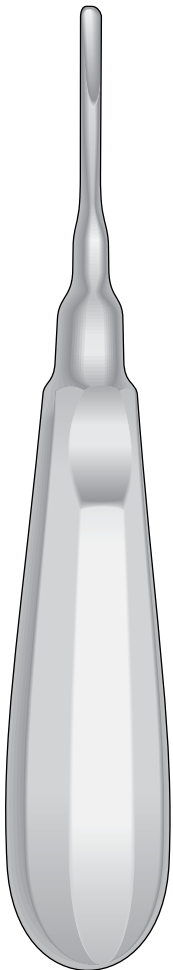
SELDIN  
**DL-48**  
# 304W  
155 mm



SELDIN  
**DL-49**  
# 34S  
155 mm

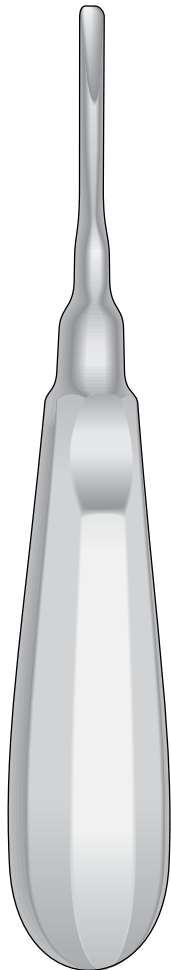


# 304W

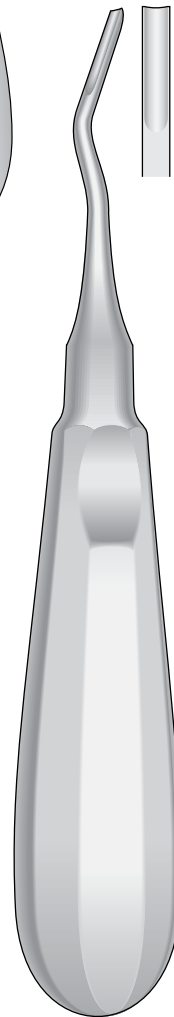
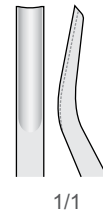


SELDIN  
**DL-48**  
# 304W  
155 mm

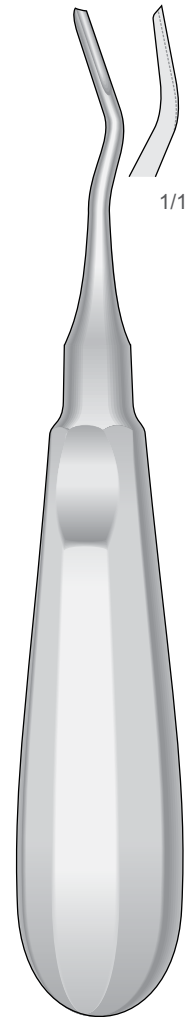
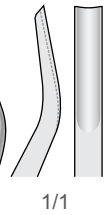
# 34S



SELDIN  
**DL-49**  
# 34S  
155 mm



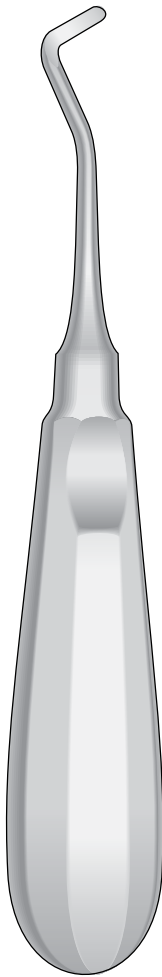
**DL-54**  
160 mm



**DL-55**  
160 mm

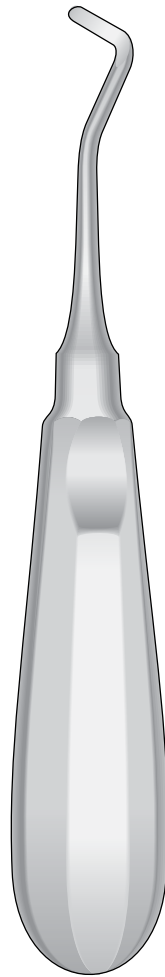


Fig. 6

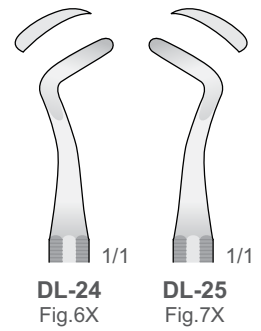


POTT  
DL-98  
160 mm

Fig. 7

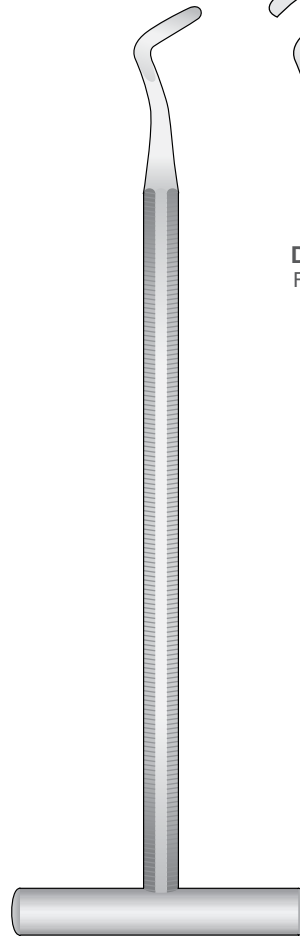


POTT  
DL-99  
160 mm



DL-24  
Fig.6X

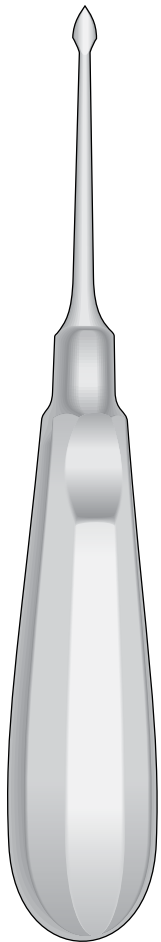
DL-25  
Fig.7X



POTT  
DL-24/DL-25  
155 mm

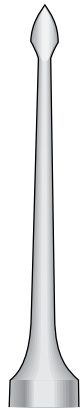
Wurzelheber  
 Root Elevators  
 Leve per radici  
 Elevadores para raíces  
 Elevateurs à racines

Syndesmotome  
 Syndesmotomes  
 Sindesmotomi  
 Syndesmôtomos  
 Syndesmotomes



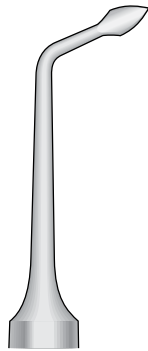
BERNARD  
 DL-73/DL-124

Gerade  
 Straight  
 Diritto  
 Rectas  
 Droites



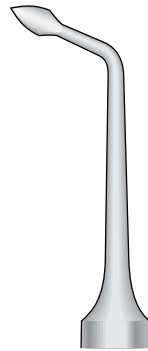
BERNARD  
 DL-73  
 150 mm

Links  
 Left  
 Sinistra  
 A la izquierda  
 À gauche



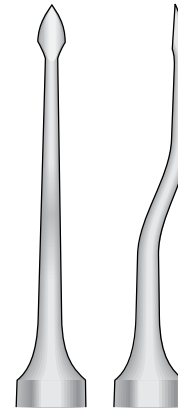
BERNARD  
 DL-74  
 140 mm

Rechts  
 Right  
 Destro  
 A la derecha  
 À droite

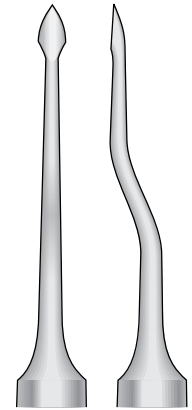


BERNARD  
 DL-75  
 140 mm

Bajonett - Bayonet  
 Baionetta - Bayoneta  
 Baionnette

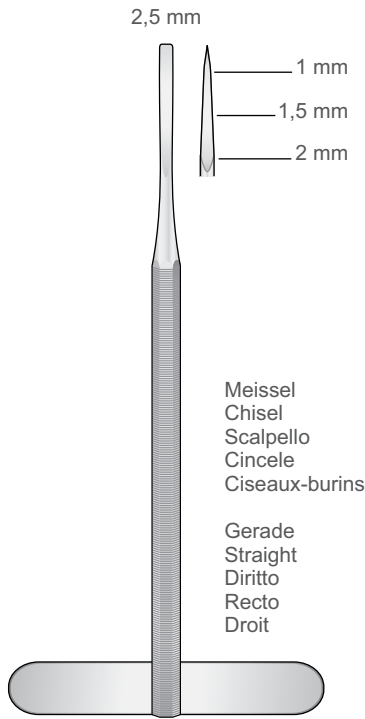


BERNARD  
 DL-123  
 150 mm



BERNARD  
 DL-124  
 150 mm

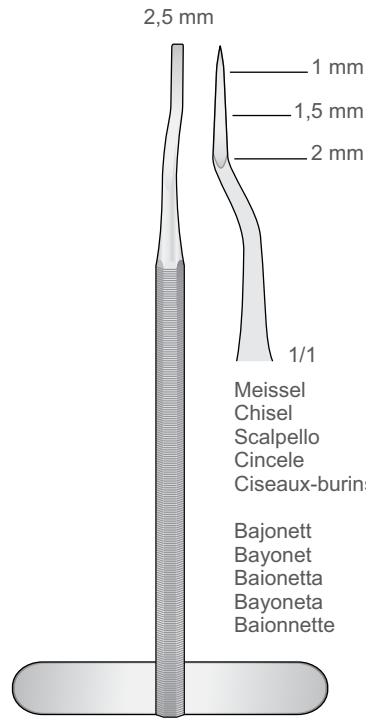
Wurzelheber  
 Root Elevators  
 Leve per radici  
 Elevadores para raíces  
 Elevateurs à racines



**DL-88**  
 130 mm

Meissel  
 Chisel  
 Scalpello  
 Cincele  
 Ciseaux-burins

Gerade  
 Straight  
 Diritto  
 Recto  
 Droit

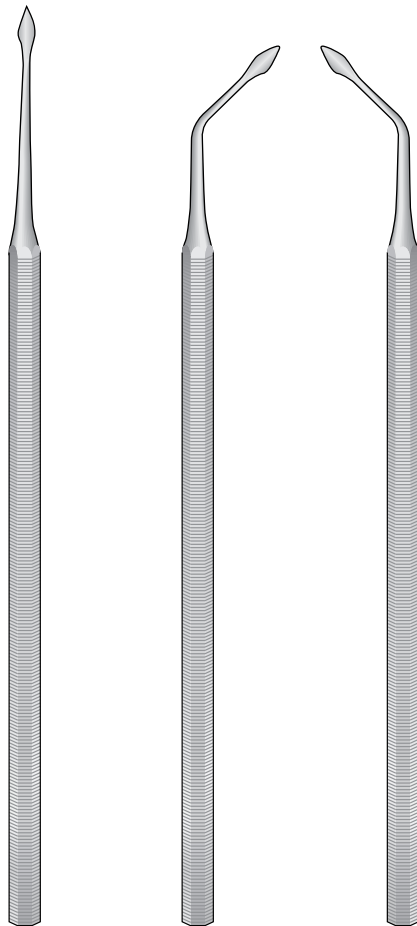


**DL-89**  
 130 mm

Meissel  
 Chisel  
 Scalpello  
 Cincele  
 Ciseaux-burins

Bajonett  
 Bayonet  
 Baionetta  
 Bayoneta  
 Baionnette

Syndesmotome  
 Syndesmotomes  
 Sindesmotomo  
 Syndesmôtomos  
 Syndesmotomes

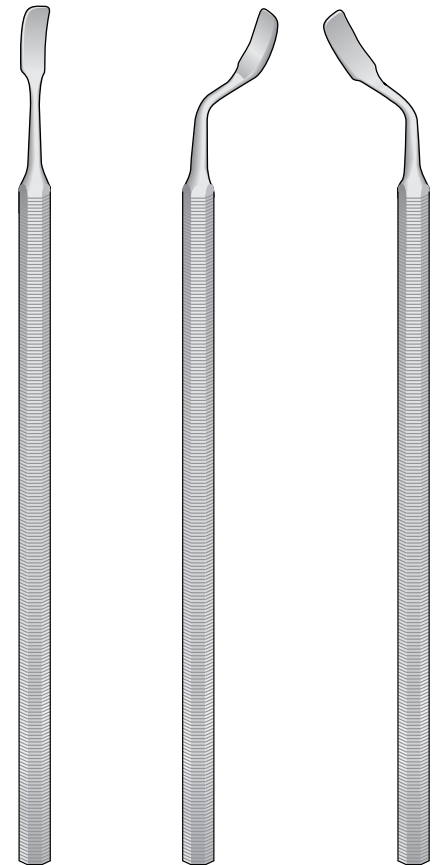


**DL-63**

**DL-62**

**DL-61**

Raspatorien  
 Raspatories  
 Scollaperiosteo  
 Legras  
 Rugines



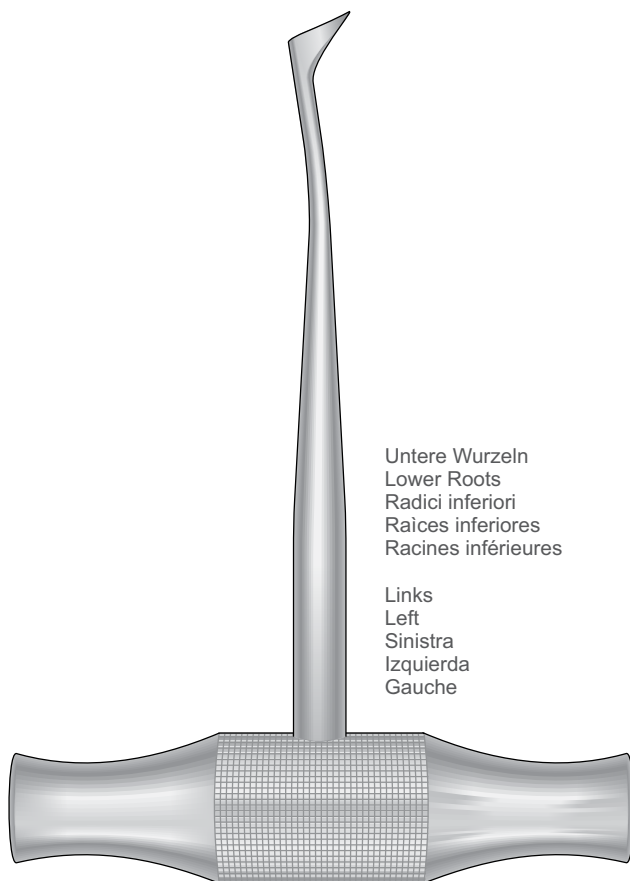
**DL-59**

**DL-68**

**DL-69**



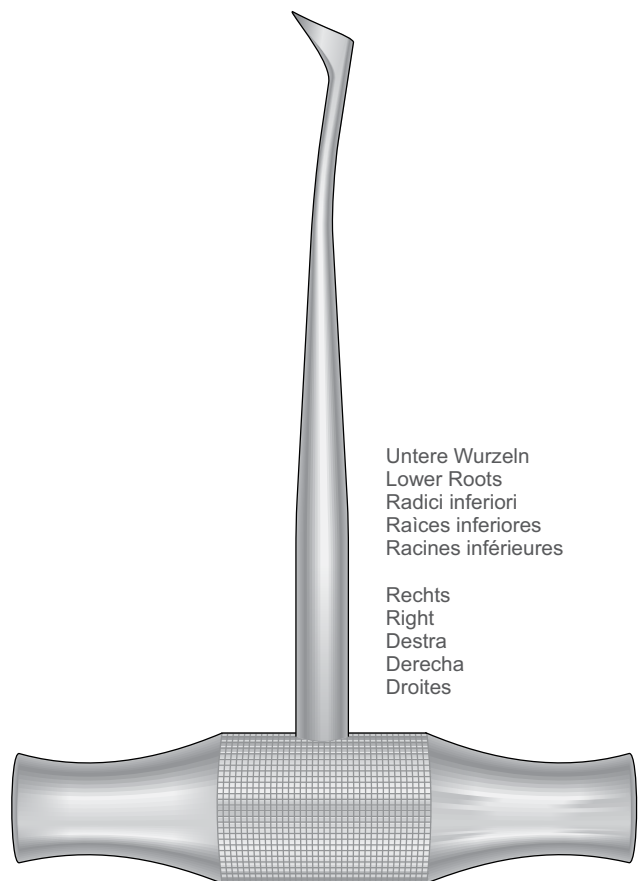
Wurzelheber  
Root Elevators  
Leve per radici  
Elevadores para raíces  
Elevateurs à racines



Untere Wurzeln  
Lower Roots  
Radici inferiori  
Raíces inferiores  
Racines inférieures

Links  
Left  
Sinistra  
Izquierda  
Gauche

WINTER  
**DL-100**  
Fig.1



Untere Wurzeln  
Lower Roots  
Radici inferiori  
Raíces inferiores  
Racines inférieures

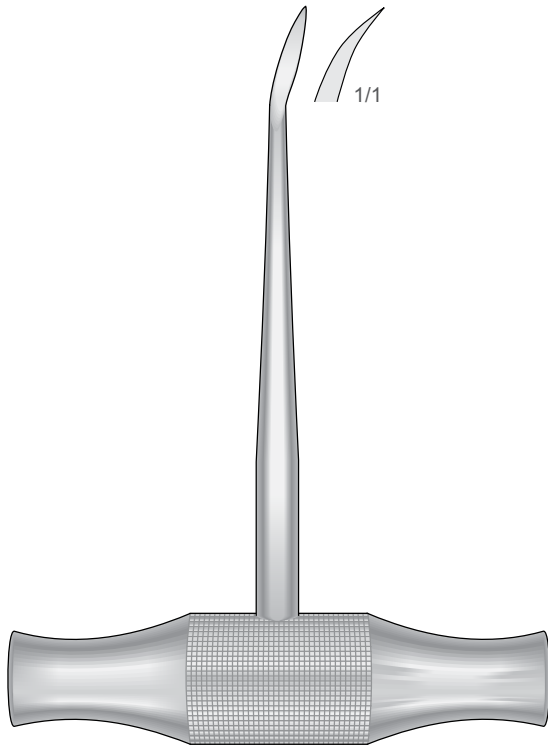
Rechts  
Right  
Destra  
Derecha  
Droites

WINTER  
**DL-101**  
Fig.2



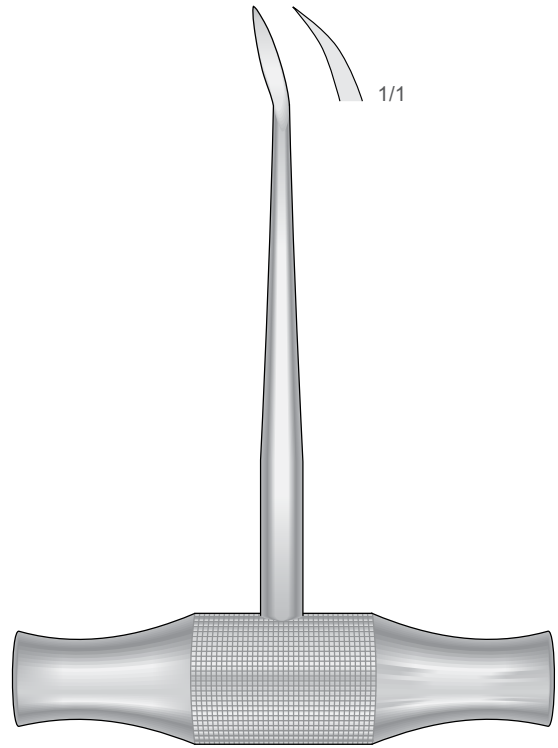
Wurzelheber  
Root Elevators  
Leve per radici  
Elevadores para raíces  
Elevateurs à racines

Fig. 1L



WINTER  
DL-64  
120 mm

Fig. 1R



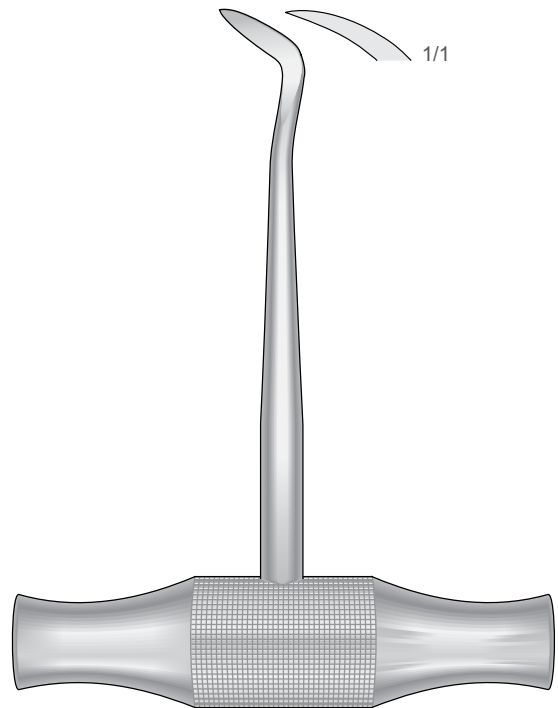
WINTER  
DL-65  
120 mm

Fig. 14L



WINTER  
DL-66  
125 mm

Fig. 14R

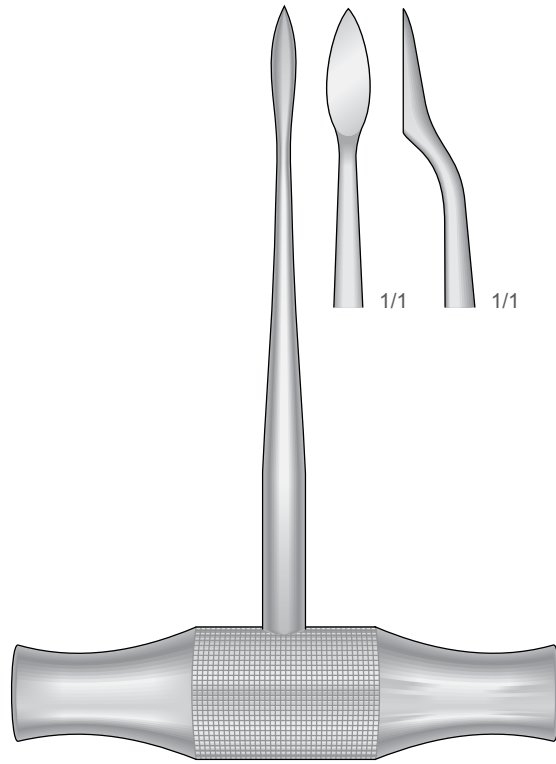


WINTER  
DL-67  
125 mm

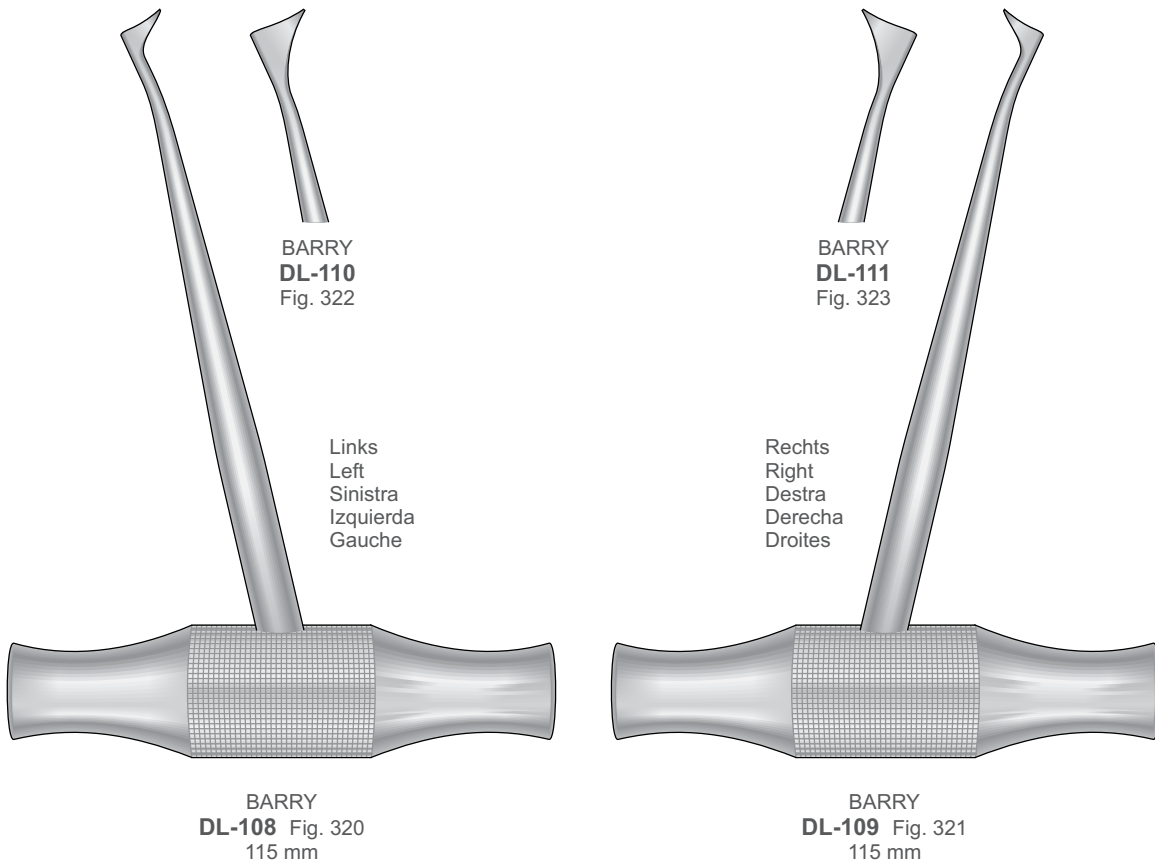




Wurzelheber  
 Root Elevators  
 Leve per radici  
 Elevadores para raíces  
 Elevateurs à racines



LECLUSE  
**DL-90**  
 130 mm



BARRY  
**DL-110**  
 Fig. 322

BARRY  
**DL-111**  
 Fig. 323

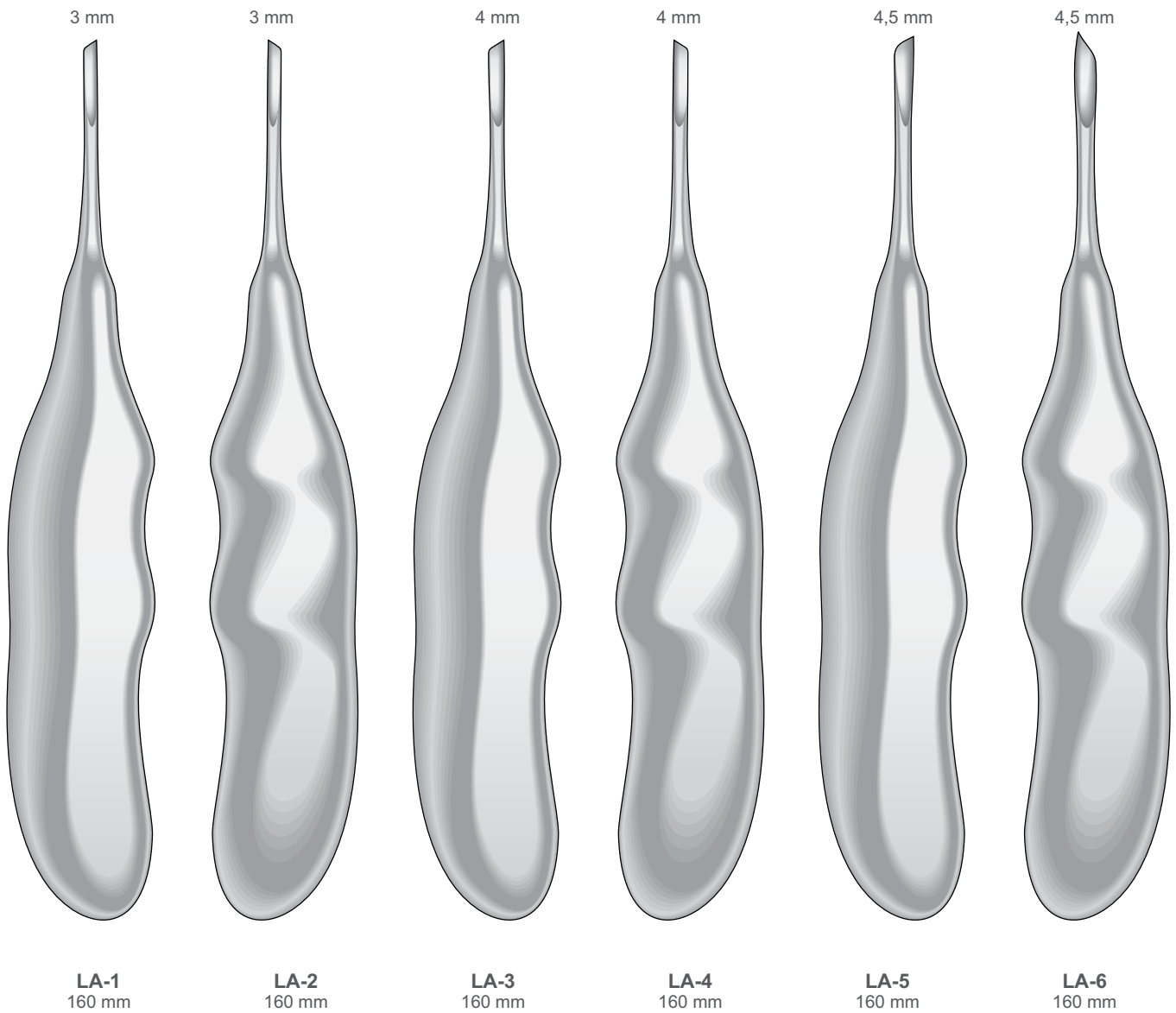
Links  
 Left  
 Sinistra  
 Izquierda  
 Gauche

Rechts  
 Right  
 Destra  
 Derecha  
 Droites

BARRY  
**DL-108** Fig. 320  
 115 mm

BARRY  
**DL-109** Fig. 321  
 115 mm





Wurzelheber  
Root Elevators  
Leve per radici  
Elevadores para raíces  
Elevateurs à racines



**LA-7**  
160 mm



**LA-8**  
160 mm



**LA-9**  
160 mm



**LA-10**  
160 mm



2 mm



**LA-11**  
155 mm

3 mm



**LA-12**  
155 mm

4 mm



**LA-13**  
155 mm



**LA-16**  
160 mm



**LA-17**  
160 mm

Wurzelheber  
Root Elevators  
Leve per radici  
Elevadores para raíces  
Elevateurs à racines



LA-20  
160 mm



LA-21  
160 mm



LA-22  
160 mm



LA-23  
160 mm



Syndesmotome  
Syndesmotomes  
Sindesmotomo  
Syndesmôtomos  
Syndesmotomes



Massiv  
Solid  
Manico  
Pieno  
Massif

CHOMPRET  
**CH-11**  
150 mm



Massiv  
Solid  
Manico  
Pieno  
Massif

CHOMPRET  
**CH-12**  
150 mm



Massiv  
Solid  
Manico  
Pieno  
Massif

CHOMPRET  
**CH-13**  
150 mm



Massiv  
Solid  
Manico  
Pieno  
Massif

CHOMPRET  
**CH-14**  
145 mm



CHOMPRET  
**CH-1**  
165 mm



CHOMPRET  
**CH-2**  
165 mm



CHOMPRET  
**CH-3**  
165 mm



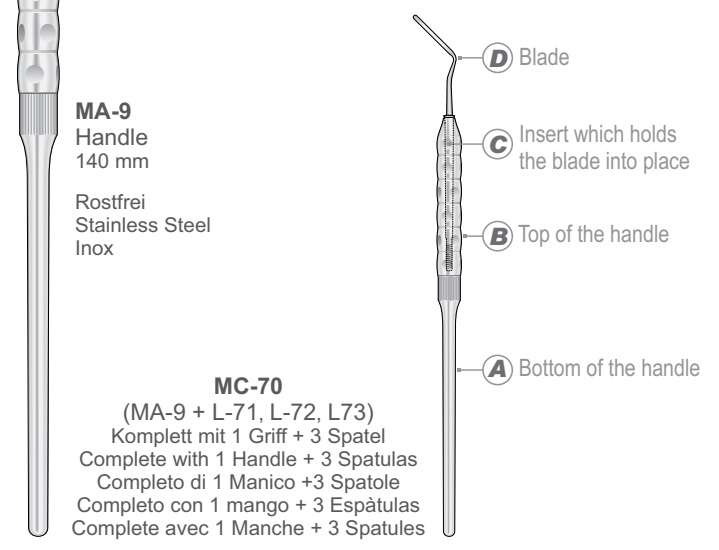
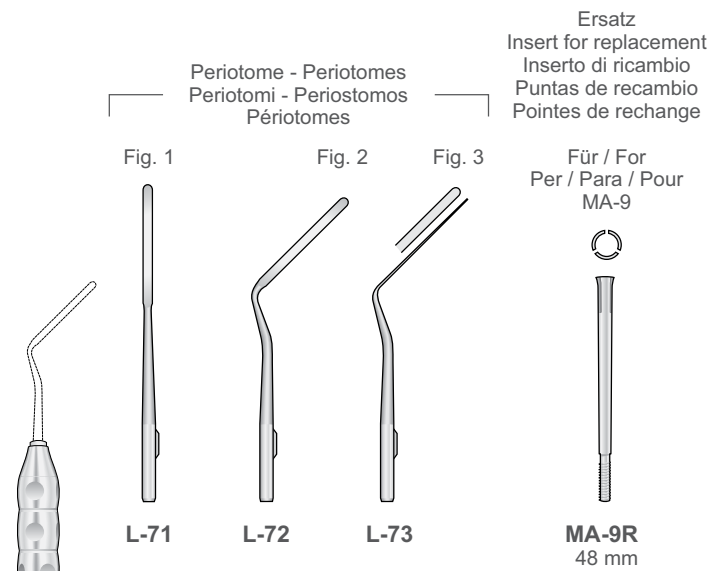
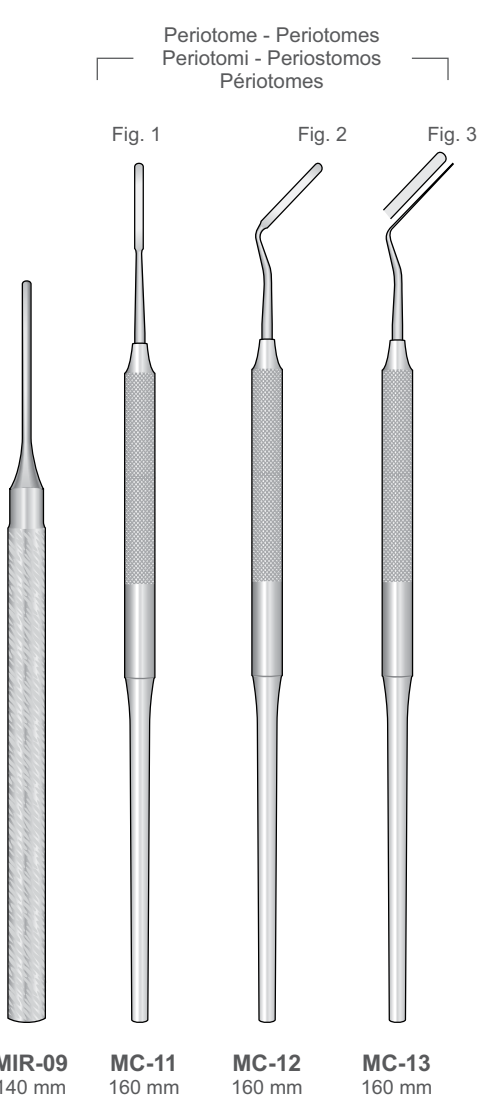
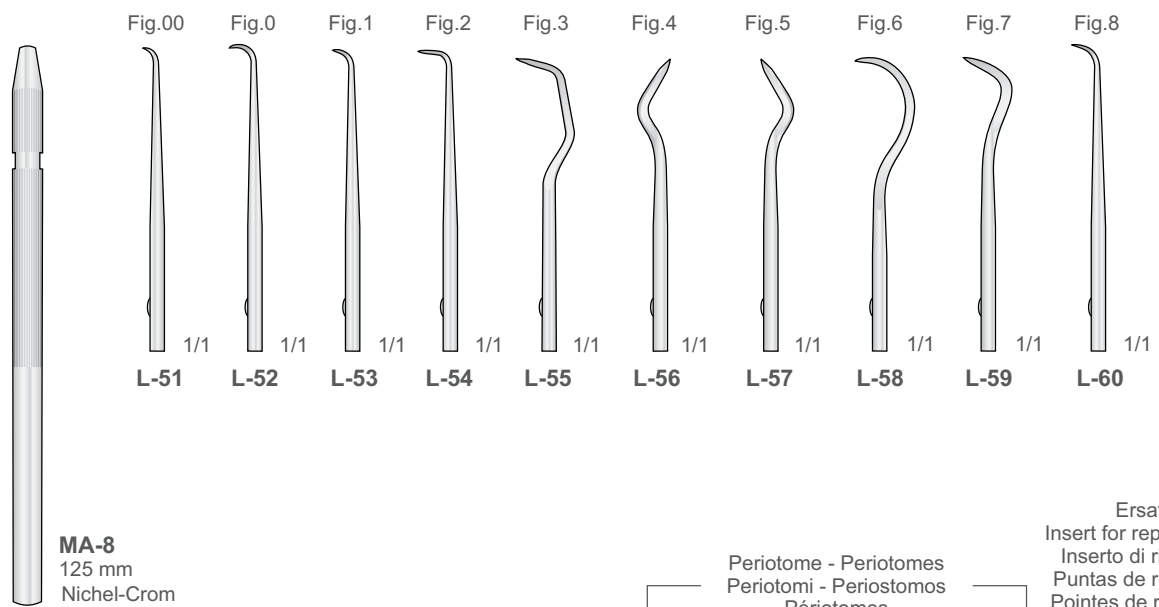
CHOMPRET  
**CH-4**  
160 mm



Zahnreiniger - Periotome  
 Scalers - Periotomes  
 Ablatori di tartaro - Periotomi  
 Limpiadores de sarro - Periotomos  
 Detartreurs - Périotomes

MORSE - SCALERS

ELEVATORS



**SDM-C**

Komplett mit 2 Griffe + 20 Klingen  
 Complete with 2 Handles + 20 Blades  
 Completo di 2 Manici + 20 lame  
 Completo con 2 mangos + 20 hojas  
 Complete avec 2 Manches + 20 lames

**SD-M**

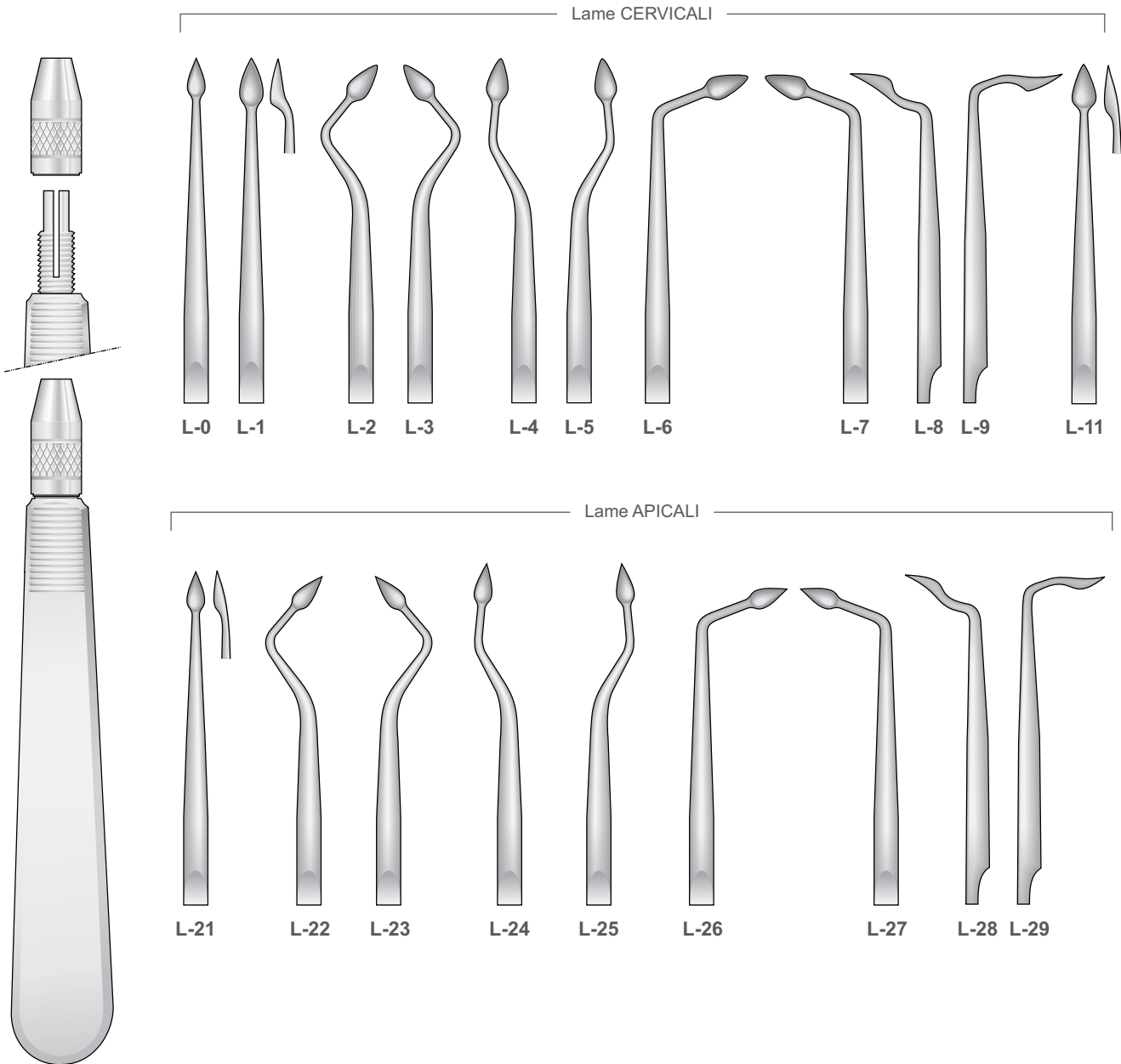
Griff  
 Handle  
 Manico  
 Mango  
 Manche

**SDM-9**

Komplett mit 2 Griffe + 9 Klingen APICALI  
 Complete with 2 Handles + 9 Blades APICALI  
 Completo di 2 Manici + 9 lame APICALI  
 Completo con 2 mangos + 9 hojas APICALI  
 Complete avec 2 Manches + 9 lames APICALI

**SDM-11**

Komplett mit 2 Griffe + 11 Klingen CERVICALI  
 Complete with 2 Handles + 11 Blades CERVICALI  
 Completo di 2 Manici + 11 lame CERVICALI  
 Completo con 2 mangos + 11 hojas CERVICALI  
 Complete avec 2 Manches + 11 lames CERVICALI



SD-M





we take a closer look

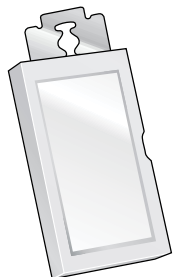
# + SCALPELS



Scalpel Handles & Blades



Skalpelligriffe - Mikro Skalpellklingen  
 Scalpel Handles - Micro Scalpel Blades  
 Manici per bisturi - Micro lame per bisturi  
 Mangos de bisturí - Micro hojas de bisturí  
 Manches pour bistouris - Micro lames de bistouri

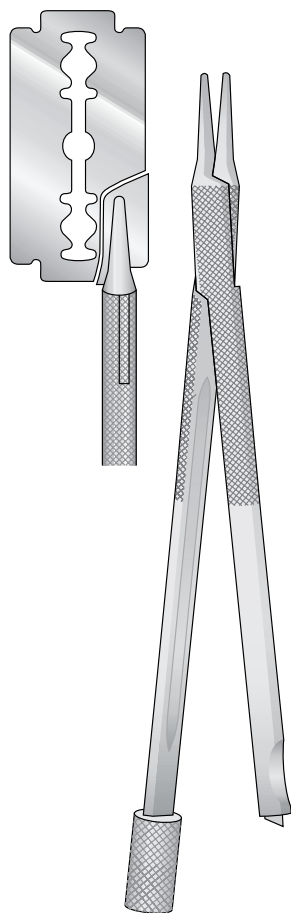


**LB-40**  
 Packung 10 Klingen  
 Package 10 blades  
 Scatola da 10 lame  
 Cajita de 10 hojas  
 Boite de 10 lames

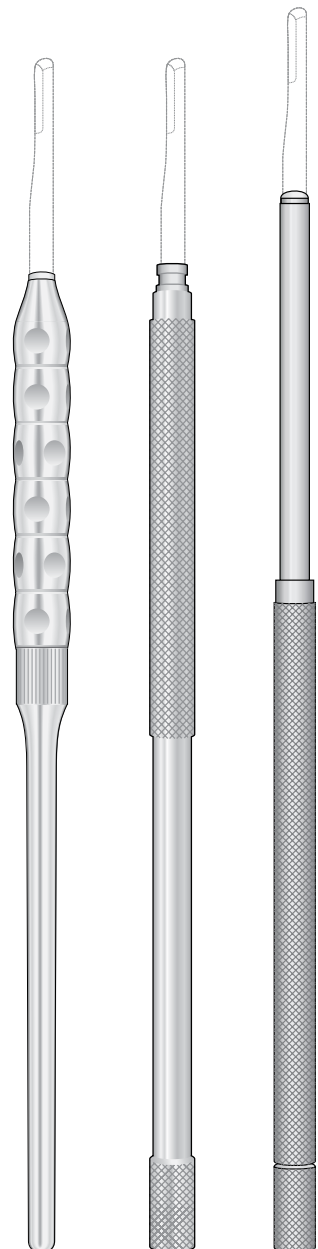
Skalpelligriffe für Mikro-Klingen  
 Scalpel handles for Micro blades  
 Manici per micro lame  
 Mangos de bisturí para micro hojas  
 Manches de bistouris pour micro lames

Micro-Klingen  
 Micro blades  
 Micro lame  
 Micro hojas  
 Micro lames

Rasierklingen-Brecker und halter  
 Razor blade breaker and holder  
 Manico porta lame  
 Mango para Hojas de afeitador  
 Porte lames à rasoir



**NK-12**  
 120 mm



**MA-11**  
 135 mm

**BB-46**  
 135 mm

**BB-48**  
 155 mm



**LB-361**  
 Conf. 10 pz.



**LB-362**  
 Conf. 10 pz.



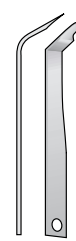
**LB-363**  
 Conf. 1 pz.



**LB-364**  
 Conf. 10 pz.



**LB-365**  
 Conf. 10 pz.



**LB-366**  
 Conf. 1 pz.



**LB-367**  
 Conf. 10 pz.



**LB-368**  
 Conf. 10 pz.

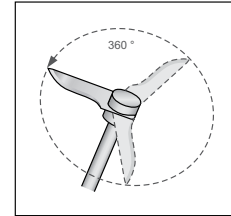


**LB-369**  
 Conf. 1 pz.



Skalpellgriffe  
Scalpel Handles  
Manici porta lame  
Mangos de bisturí  
Manches de bistouri

Für Mikro-Klingen  
For Micro Blades  
Per micro lame  
Para micro Hojas  
Pour Micro-Lame de bistouris



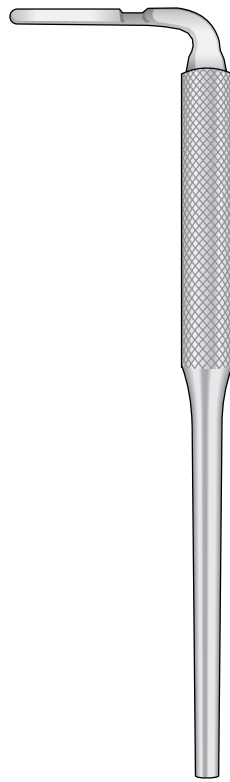
**NK-1**  
100 mm



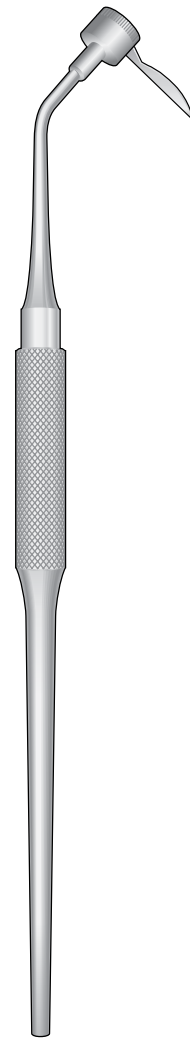
**NK-3**  
130 mm



**NK-2**  
150 mm



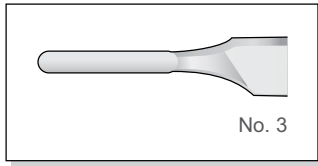
**MA-B16**  
120 mm



**GB-4**  
165 mm



Skalpelle und Skalpellgriffe  
 Scalpel Blades and Handle  
 Lame e manici per bisturi  
 Hojas y mangos de bisturí  
 Lames et manches de bistouri



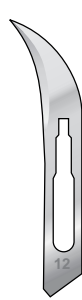
Packungen à 100  
 Packages of 100 ea  
 Scatole da 100 pezzi  
 Cajas de 100 c/u  
 Boîtes de 100 pièces



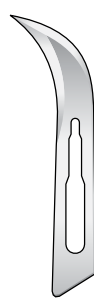
**LB-10**  
Fig. 10



**LB-11**  
Fig. 11



**LB-12**  
Fig. 12



**LB-12D**  
Fig. 12D



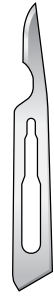
**LB-13**  
Fig. 13



**LB-15**  
Fig. 15



**LB-15A**  
Fig. 15A



**LB-15C**  
Fig. 15C

SCALPELS



**MA-B3**



**MA-B3M**  
Fig. 3M



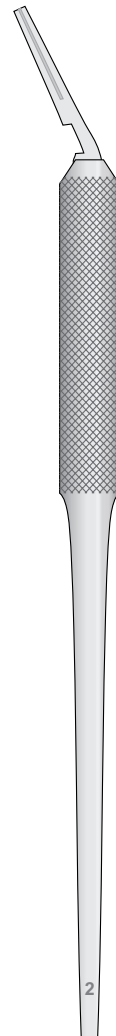
**MA-B7**



**MA-B7K**



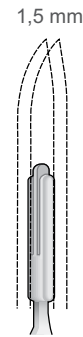
**MA-B1**  
Fig. 5



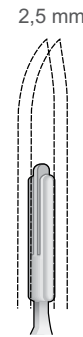
**MA-B2**  
Fig. 5A



**MA-B8/MA-B9**  
155 mm



**MA-B8**



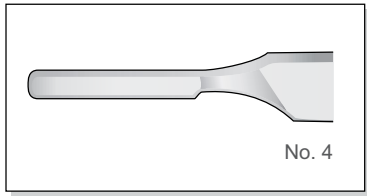
**MA-B9**

Doppelt Skalpellgriff  
 Scalpel Handle double Blade  
 Manico per bisturi a doppia lama  
 Mango de bisturi doble hojas  
 Manche pour bistouri double-lames



**SCALPELS**

Skalpelle  
Scalpel Blades  
Lame per bisturi  
Hojas de bisturí  
Lames de bistouri



No. 4

Packungen à 100  
Packages of 100 ea  
Scatole da 100 pezzi  
Cajas de 100 c/u  
Boîtes de 100 pièces



**LB-18**  
Fig. 18



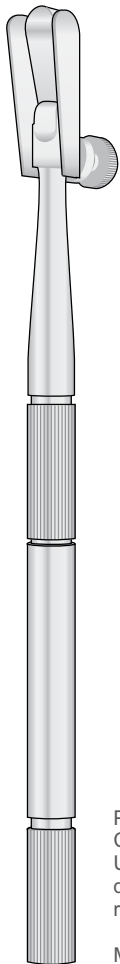
**LB-20**  
Fig. 20



**LB-21**  
Fig. 21



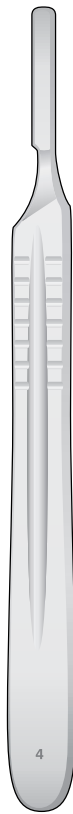
**LB-23**  
Fig. 23



**PAQUETTE  
BLADE HOLDER  
GB-2**  
160 mm

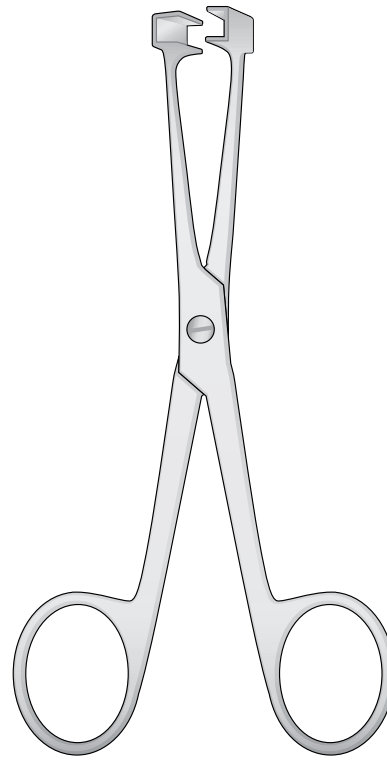
Palatal, Gingival,  
Connective Tissue Grafts  
Uses standard  
double-edged  
razor blade

Mucotomo

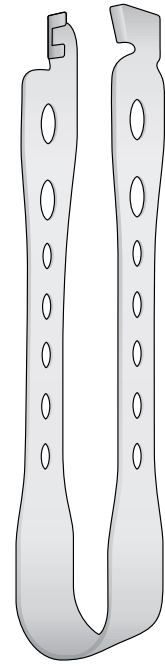


**MA-B4**  
Fig. 4

Klingentfemer  
Scalpel blade removing forceps  
Pinze togilama  
Pinza para quitar hojas de bisturíes  
Pince pour enlever les lames de bistouris



**GS-18**  
135 mm



**GS-16**  
115 mm



Messer  
Knives  
Coltelli  
Cuchillos  
Couteaux



**NK-06**  
5 mm



**NK-08**  
6 mm



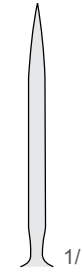
**NK-10**  
7 mm



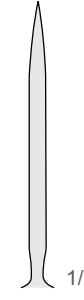
**NK-14**  
125 mm



**NK-16**  
135 mm



**NK-18**  
35 mm

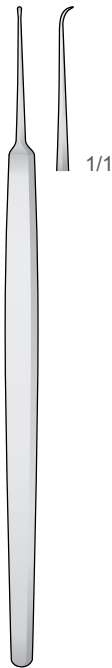


**NK-20**  
35 mm

ZIEGLER  
**NK-06/NK-10**  
115 mm

GRAEFE  
**NK-14/NK-16**

GRAEFE  
**NK-18/NK-20**  
140 mm



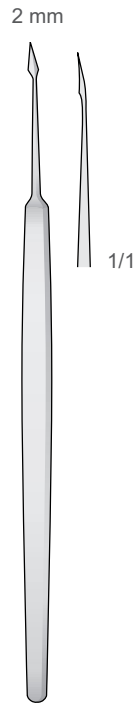
LA FORCE  
**NK-07**  
120 mm



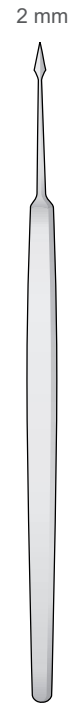
ELLIS  
**NK-09**  
120 mm



**NK-11**  
125 mm



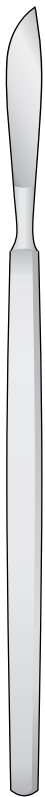
**NK-17**  
125 mm



**NK-39**  
125 mm

SCALPELS





NK-30/NK-40



**NK-30**  
120 mm



**NK-32**  
125 mm



**NK-34**  
130 mm



**NK-36**  
120 mm



**NK-38**  
125 mm



**NK-40**  
130 mm

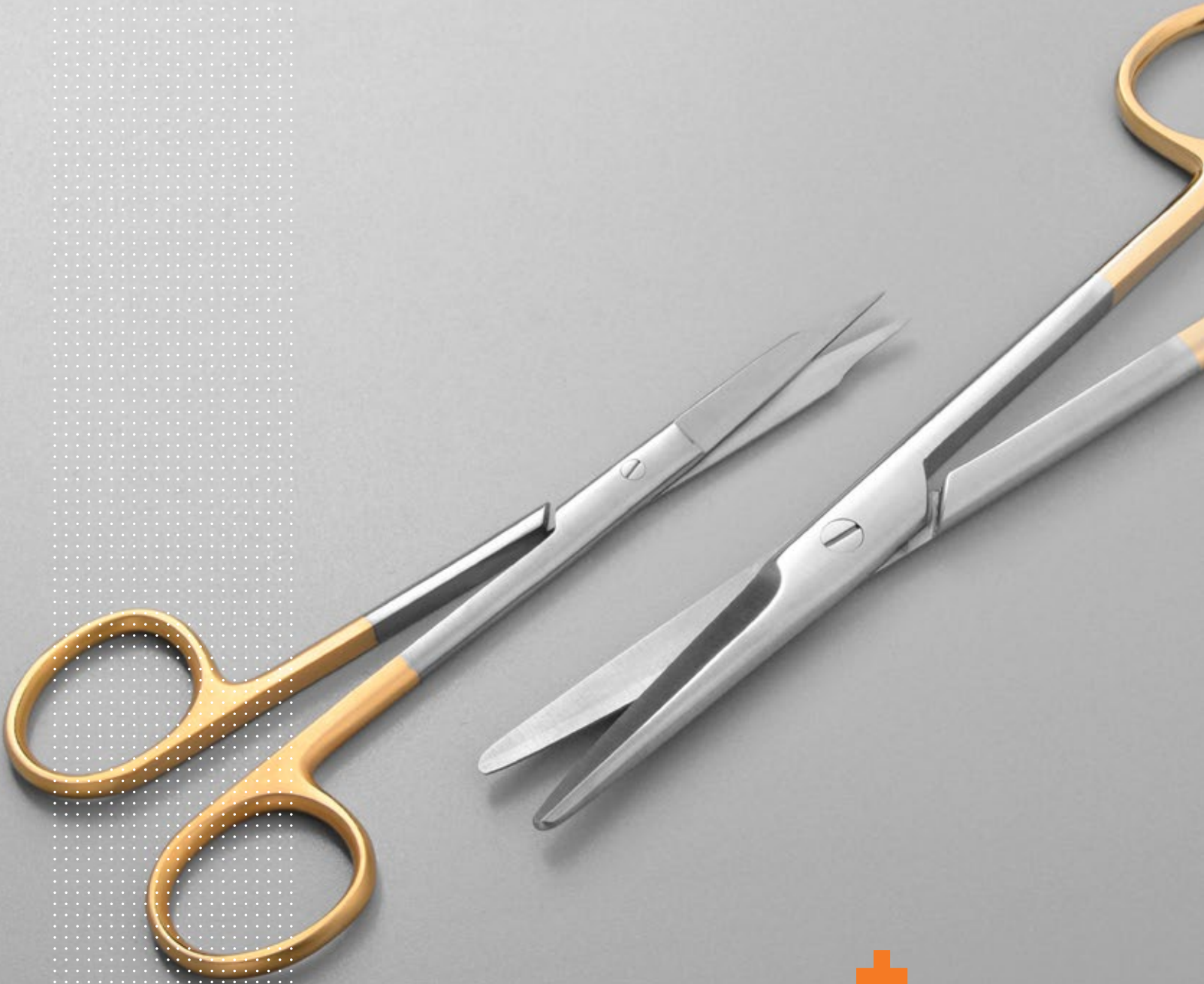






we take a closer look

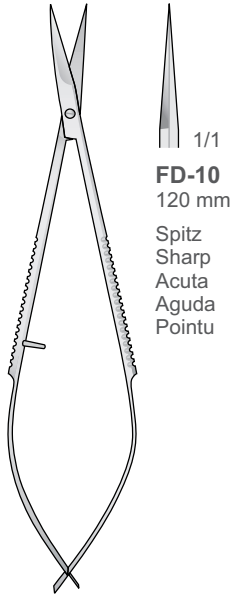
# + SCISSORS



Micro Scissors  
Surgical Scissors  
Ligature Scissors  
Wire & Plate

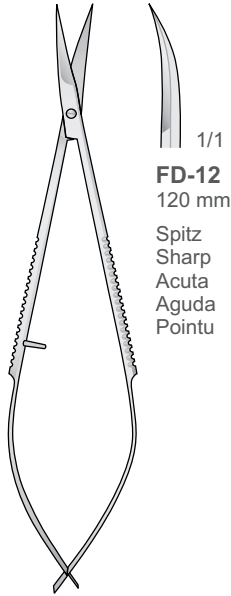


Mikro-Scheren  
 Micro Scissors  
 Micro Forbici  
 Micro Tijeras  
 Micro Ciseaux



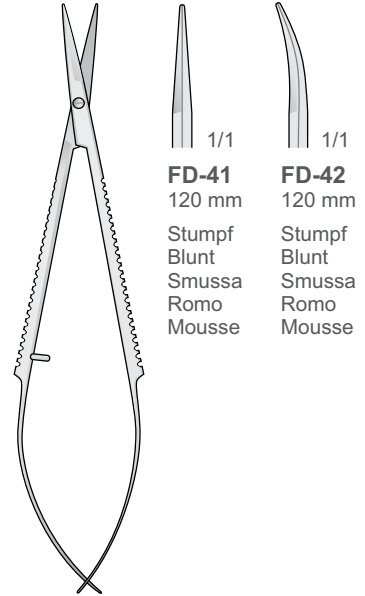
1/1  
**FD-10**  
 120 mm  
 Spitz  
 Sharp  
 Acuta  
 Aguda  
 Pointu

NOYES  
**FD-10**  
 120 mm



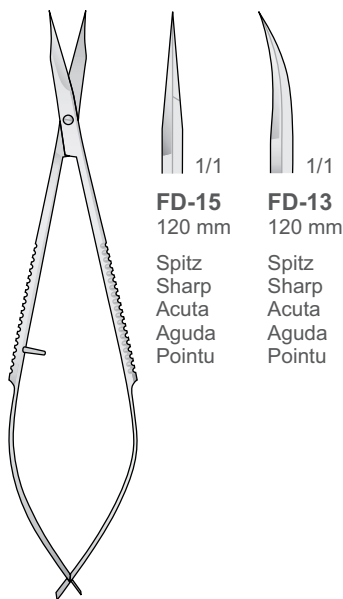
1/1  
**FD-12**  
 120 mm  
 Spitz  
 Sharp  
 Acuta  
 Aguda  
 Pointu

NOYES  
**FD-12**  
 120 mm



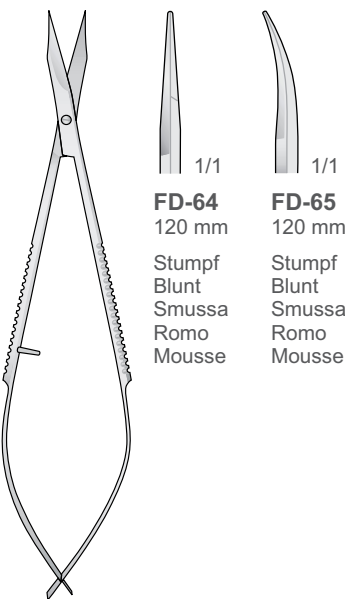
1/1 1/1  
**FD-41** **FD-42**  
 120 mm 120 mm  
 Stumpf  
 Blunt  
 Smussa  
 Romo  
 Mousse

**FD-41/FD-42**  
 120 mm



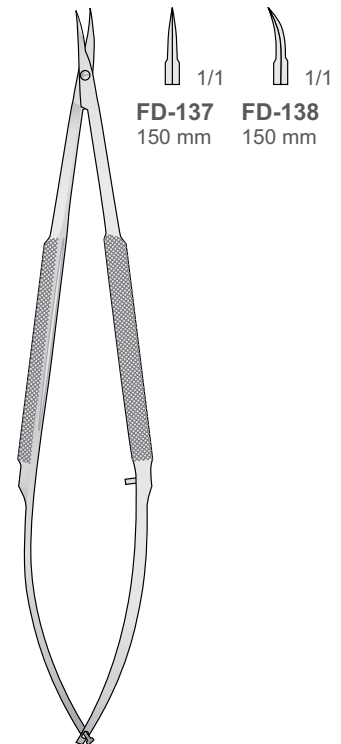
1/1 1/1  
**FD-15** **FD-13**  
 120 mm 120 mm  
 Spitz  
 Sharp  
 Acuta  
 Aguda  
 Pointu

WESTCOTT  
**FD-13/FD-15**  
 120 mm



1/1 1/1  
**FD-64** **FD-65**  
 120 mm 120 mm  
 Stumpf  
 Blunt  
 Smussa  
 Romo  
 Mousse

WESTCOTT  
**FD-64/FD-65**  
 120 mm

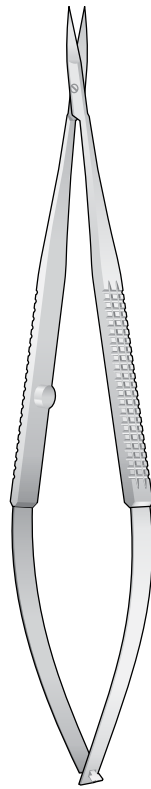


1/1 1/1  
**FD-137** **FD-138**  
 150 mm 150 mm

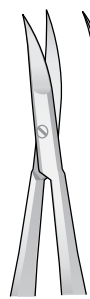
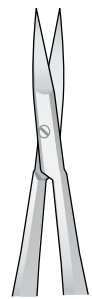
**FD-137/FD-138**  
 150 mm

SCISSORS



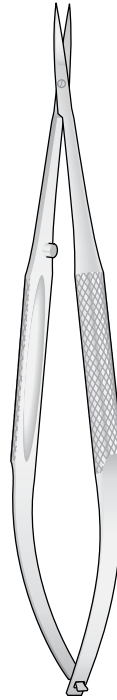


**FD-182**  
160 mm  
Spitz  
Sharp  
Acuta  
Aguda  
Pointu



**FD-183**  
160 mm  
Spitz  
Sharp  
Acuta  
Aguda  
Pointu

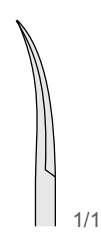
1/1



**FD-224**  
145 mm  
Spitz  
Sharp  
Acuta  
Aguda  
Pointu



1/1

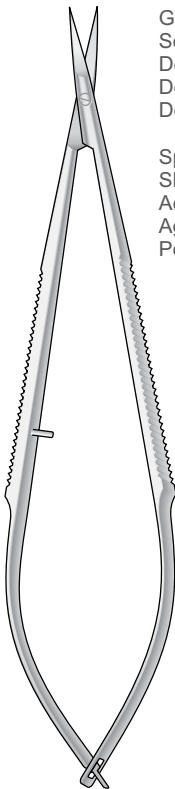


1/1

**FD-225**  
145 mm  
Spitz  
Sharp  
Acuta  
Aguda  
Pointu

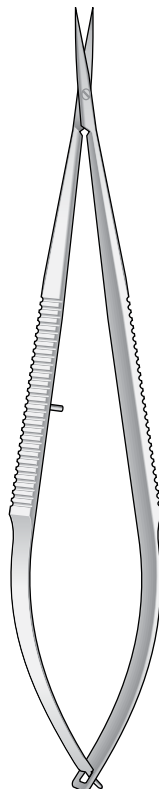
**FD-182/FD-183**  
160 mm

**FD-224/FD-225**  
145 mm



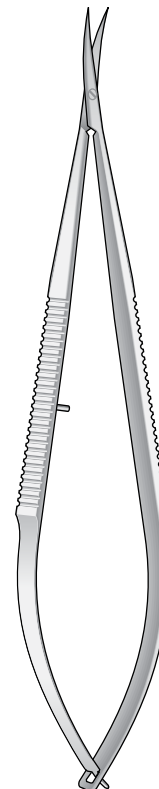
Gezahnt  
Serrated  
Dentellata  
Dentada  
Dentelé  
  
Spitz  
Sharp  
Acuta  
Aguda  
Pointu

**FD-145**  
160 mm



1/1  
**FD-06**  
160 mm  
Spitz  
Sharp  
Acuta  
Aguda  
Pointu

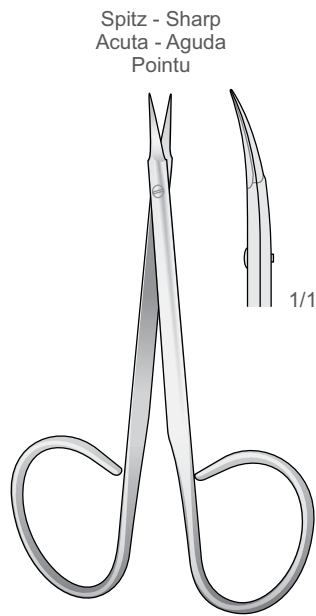
**FD-06**  
160 mm



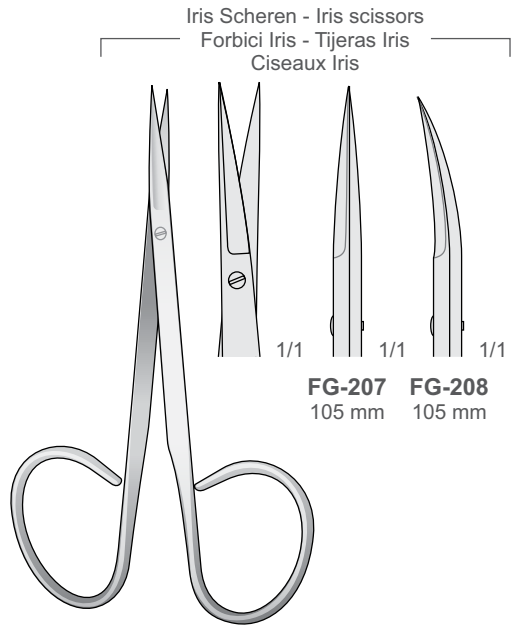
1/1  
**FD-08**  
160 mm  
Spitz  
Sharp  
Acuta  
Aguda  
Pointu

**FD-08**  
160 mm

Scheren  
Scissors  
Forbici  
Tijeras  
Ciseaux

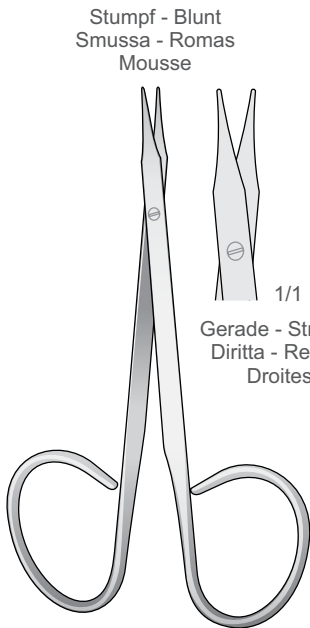


STITCH  
**FG-216**  
115 mm

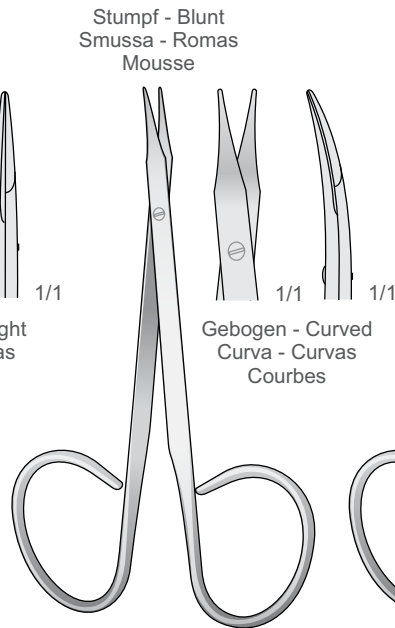


**FG-207/FG-208**  
105 mm

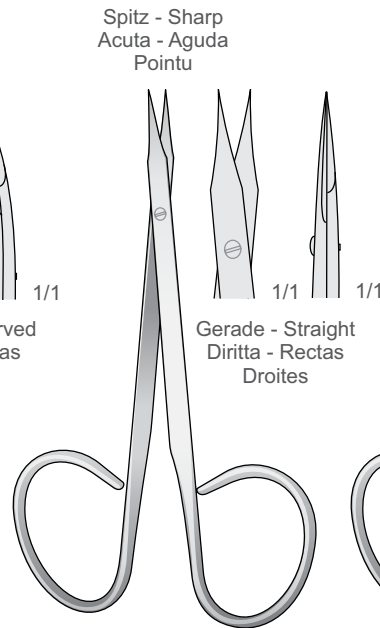
SCISSORS



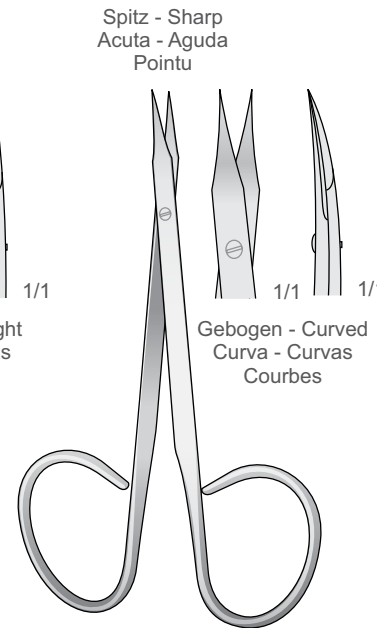
STEVENS  
**FG-209**  
100 mm



STEVENS  
**FG-210**  
100 mm



WALTON  
**FG-211**  
100 mm

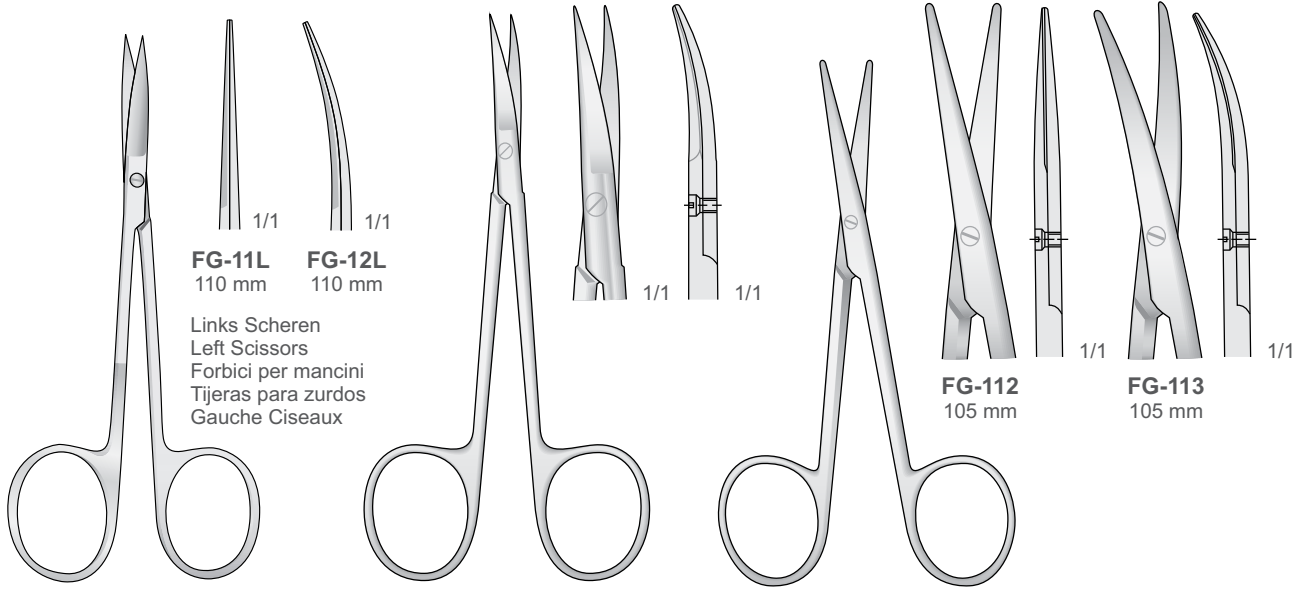


WALTON  
**FG-212**  
100 mm



L = links  
left  
mancini  
izquierdo  
gauche

SCISSORS



**FG-11L**  
110 mm

**FG-12L**  
110 mm

Links Scheren  
Left Scissors  
Forbici per mancini  
Tijeras para zurdos  
Gauche Ciseaux

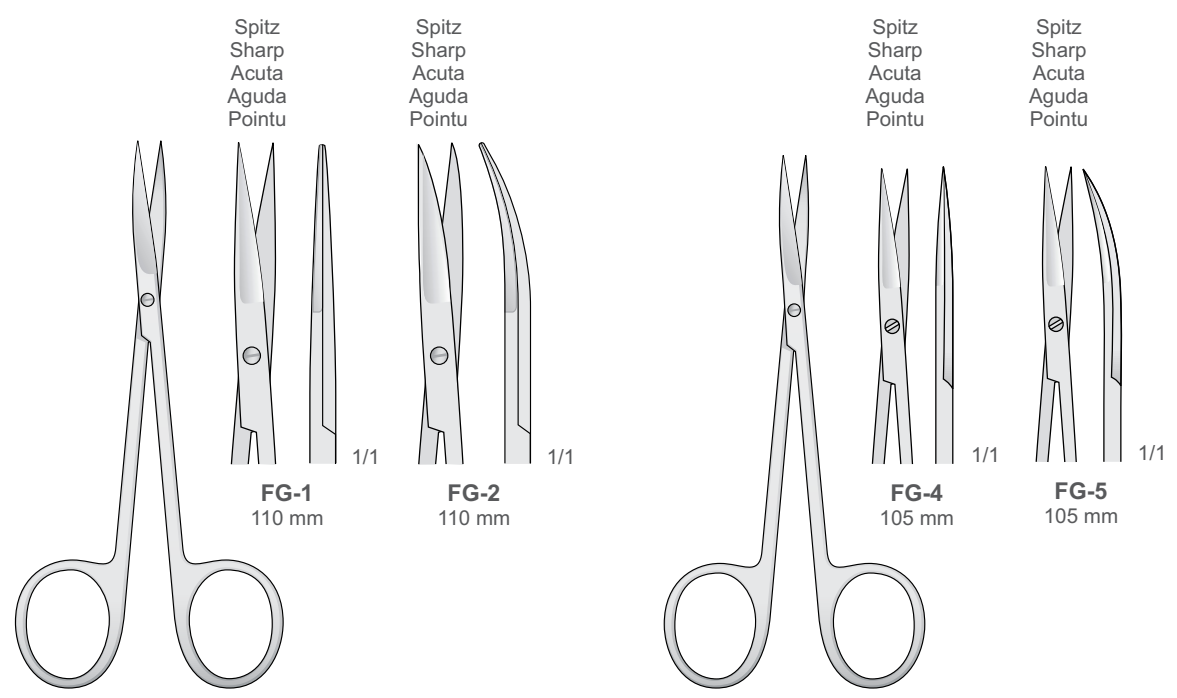
**FG-112**  
105 mm

**FG-113**  
105 mm

IRIS  
**FG-11L/FG-12L**  
110 mm

COTTLE  
**FG-59**  
115 mm

COTTLE-KNAPP  
**FG-112/FG-113**  
105 mm



Spitz  
Sharp  
Acuta  
Aguda  
Pointu

Spitz  
Sharp  
Acuta  
Aguda  
Pointu

Spitz  
Sharp  
Acuta  
Aguda  
Pointu

Spitz  
Sharp  
Acuta  
Aguda  
Pointu

**FG-1**  
110 mm

**FG-2**  
110 mm

**FG-4**  
105 mm

**FG-5**  
105 mm

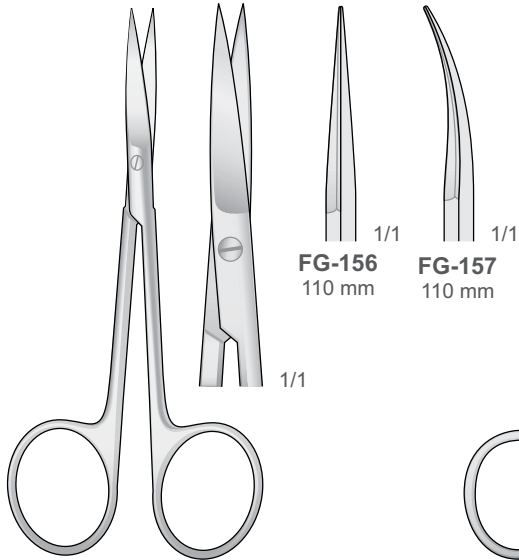
IRIS  
**FG-1/FG-2**  
110 mm

IRIS  
**FG-4/FG-5**  
105 mm



Scheren  
Scissors  
Forbici  
Tijeras  
Ciseaux

Gezahnt - Serrated  
Dentellata - Dentelé - Dentadas

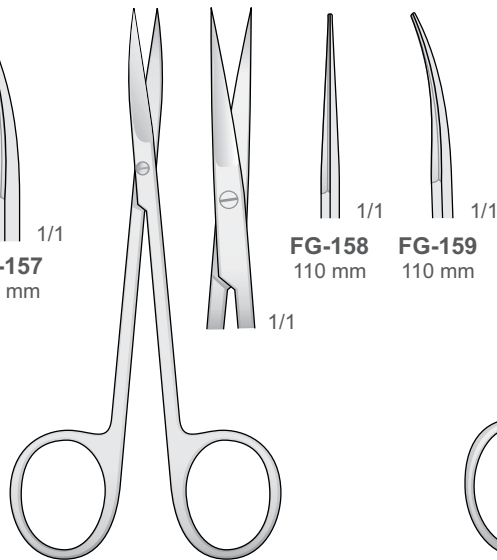


**FG-156**  
110 mm

**FG-157**  
110 mm

**FG-156/FG-157**  
110 mm

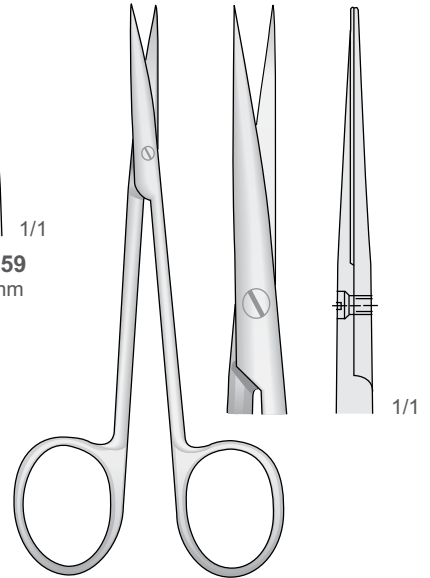
Gezahnt - Serrated  
Dentellata - Dentelé - Dentadas



**FG-158**  
110 mm

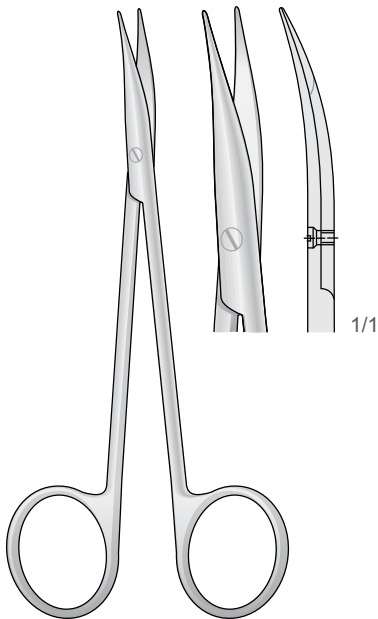
**FG-159**  
110 mm

**FG-158/FG-159**  
110 mm

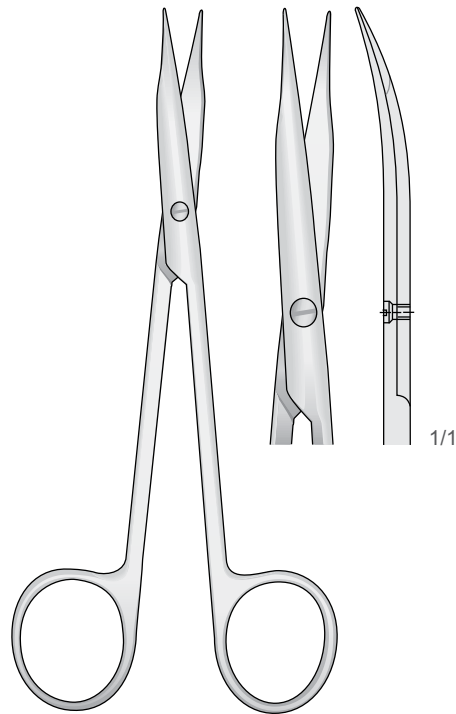


**KILNER**  
**FG-58**  
115 mm

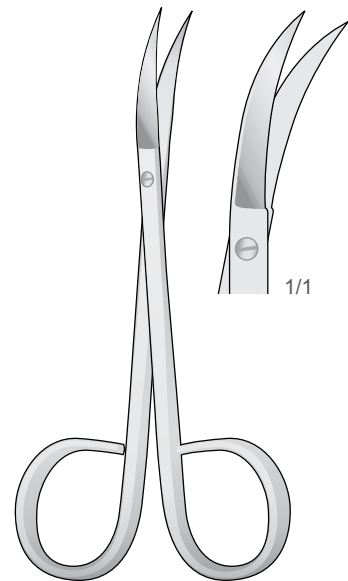
SCISSORS



**JAMESON-WERBER**  
**FG-123**  
130 mm

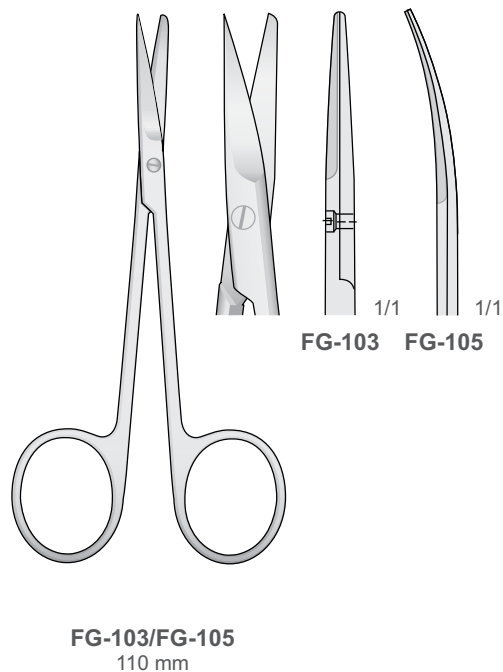
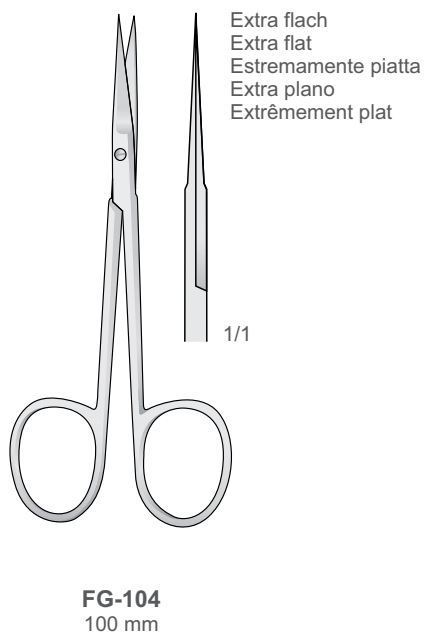
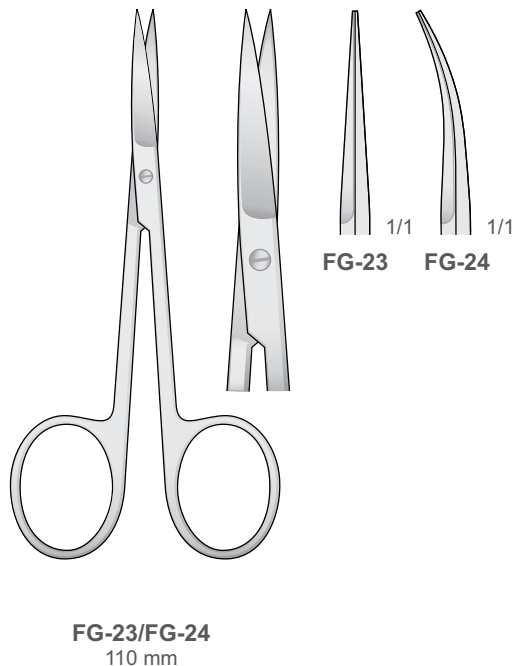
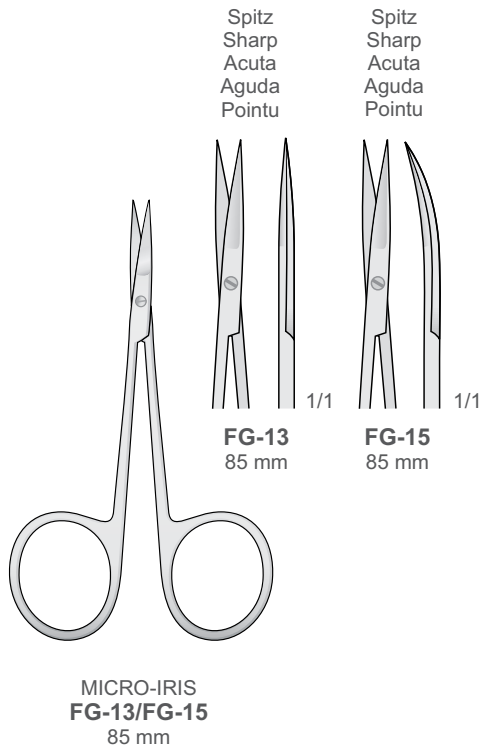


**JAMESON**  
**FG-124**  
145 mm



**FG-3**  
115 mm



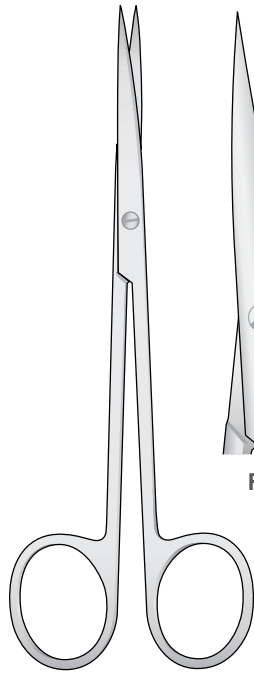




Scheren  
Scissors  
Forbici  
Tijeras  
Ciseaux

Spitz - Sharp  
Acuta - Agudo  
Aigu

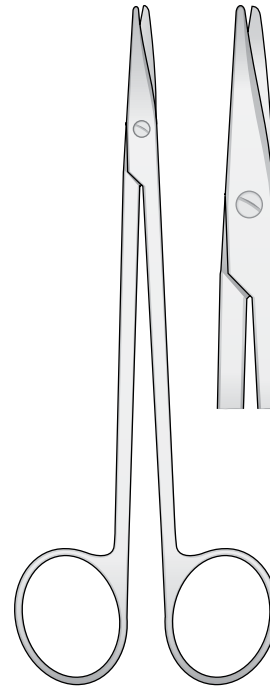
Spitz - Sharp  
Acuta - Agudo  
Aigu



**FM-126**

**FM-127**

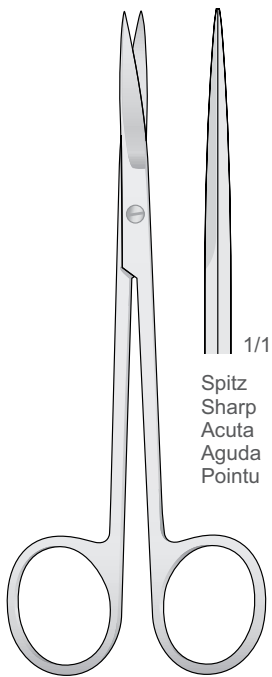
**METZENBAUM  
FM-126/FM-127**  
145 mm



**FM-12 FM-109**

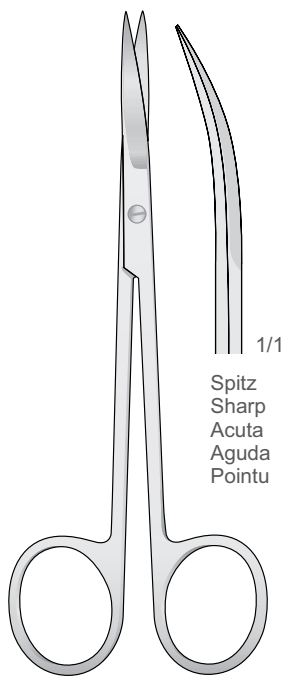
**METZENBAUM  
FM-12/FM-109**  
150 mm

SCISSORS



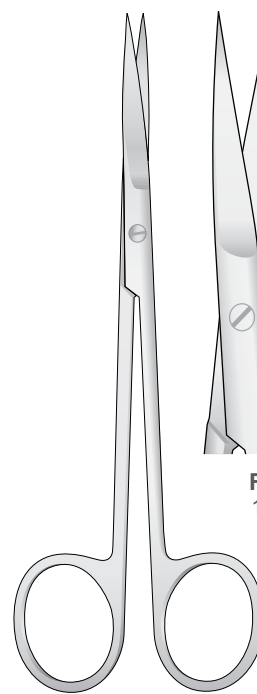
1/1  
Spitz  
Sharp  
Acuta  
Aguda  
Pointu

**METZENBAUM  
FG-28**  
145 mm



1/1  
Spitz  
Sharp  
Acuta  
Aguda  
Pointu

**METZENBAUM  
FG-14**  
145 mm



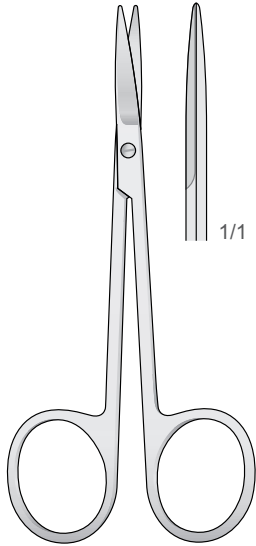
**FG-147**  
150 mm

**FG-148**  
150 mm

**JOSEPH  
FG-147/FG-148**  
150 mm

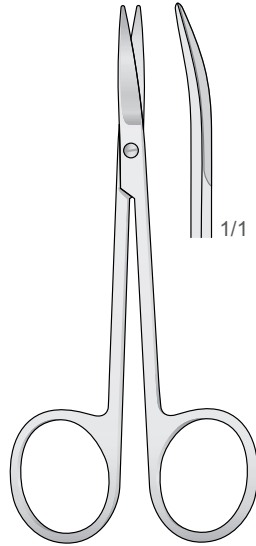


Stumpf  
Blunt  
Smussa  
Romas  
Mousse



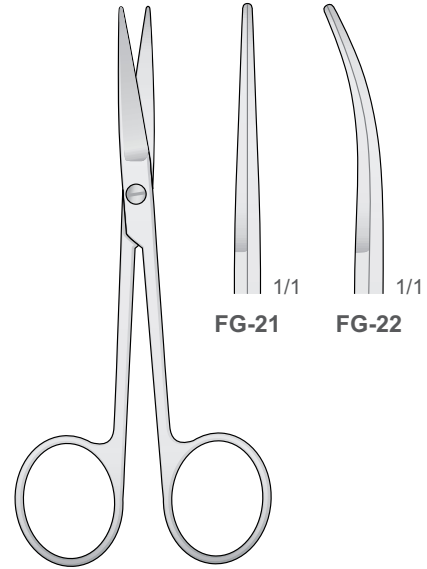
**FG-101**  
110 mm

Stumpf  
Blunt  
Smussa  
Romas  
Mousse



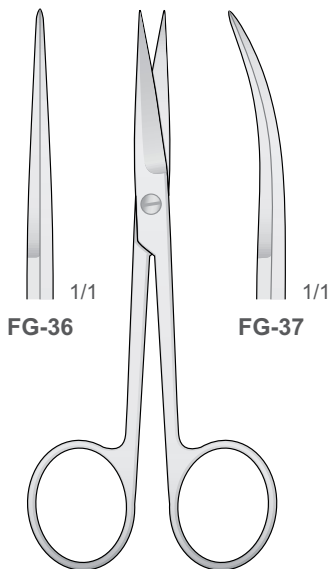
**FG-102**  
110 mm

Stumpf  
Blunt  
Smussa  
Romas  
Mousse



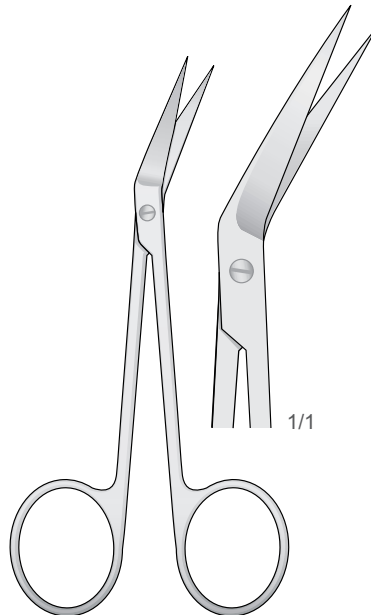
**FG-21/FG-22**  
115 mm

Spitz  
Sharp  
Acute  
Agudas  
Pointu

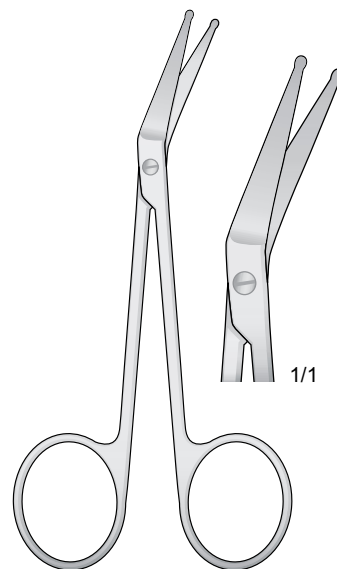


**FG-36/FG-37**  
115 mm

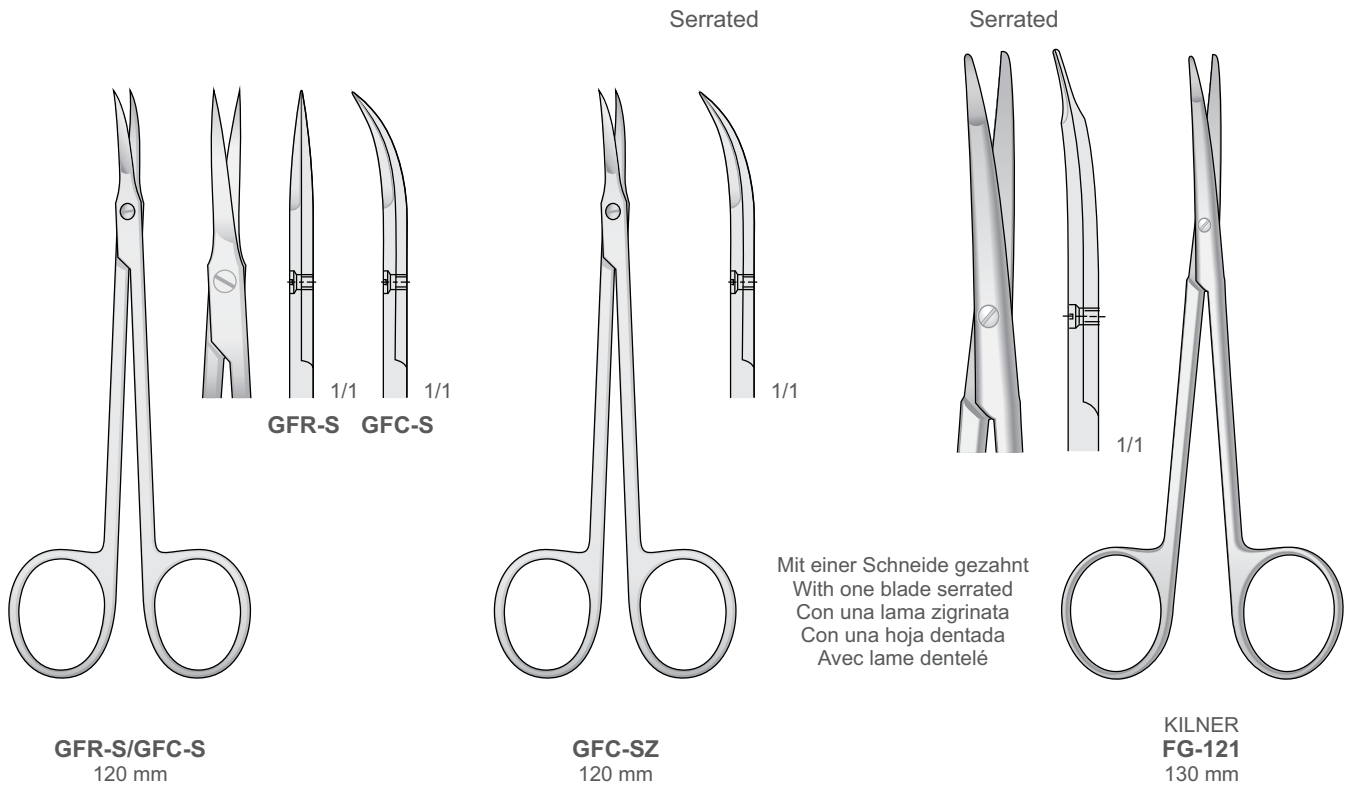
LOCKLIN  
**LK-1**  
115 mm



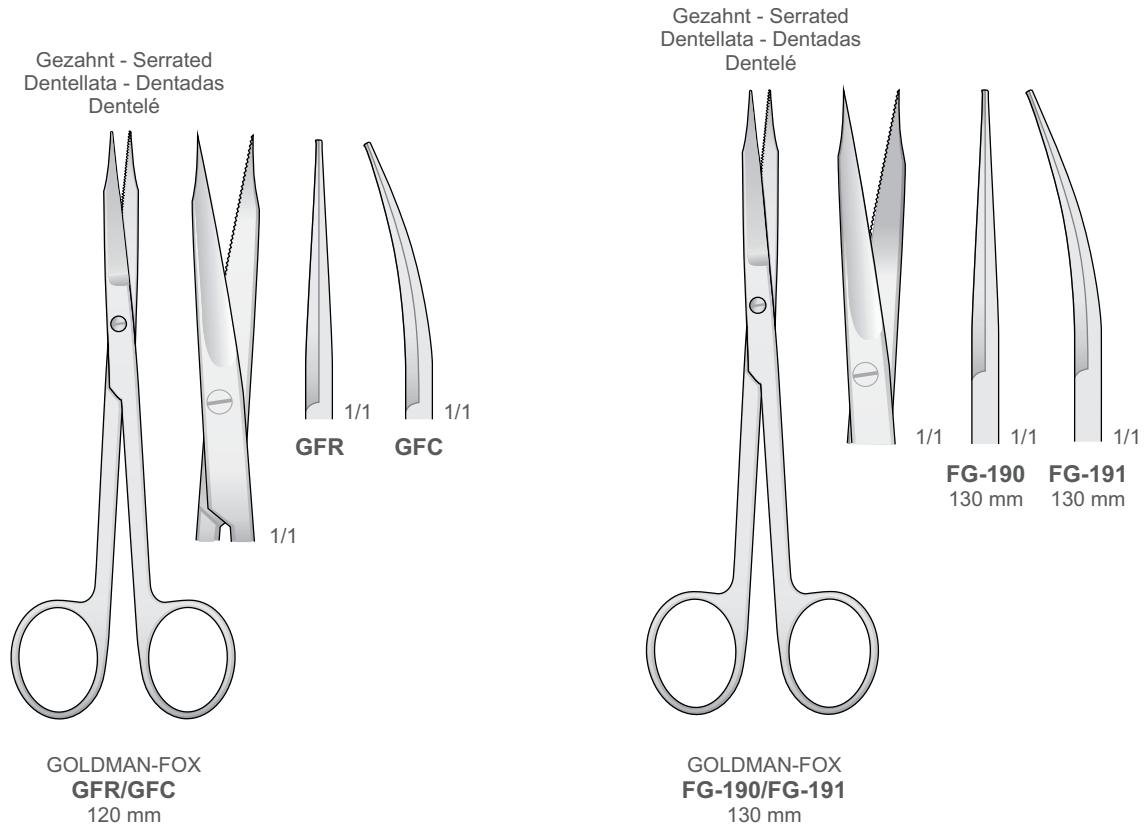
LOCKLIN MOD.  
**LK-3**  
110 mm



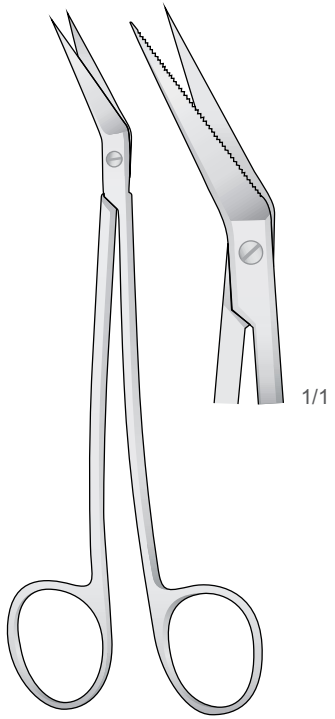
Scheren  
Scissors  
Forbici  
Tijeras  
Ciseaux



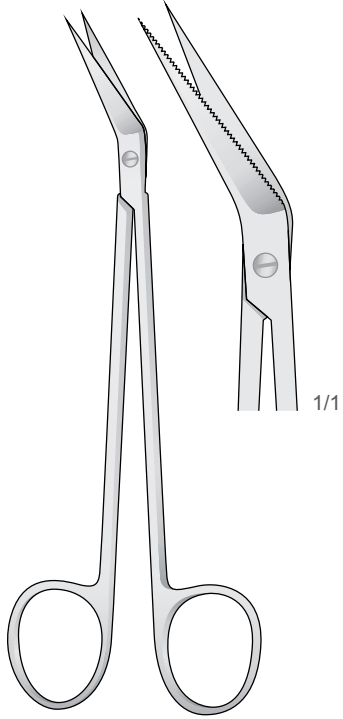
SCISSORS



Gezahnt - Serrated  
Dentellata - Dentadas  
Dentelé

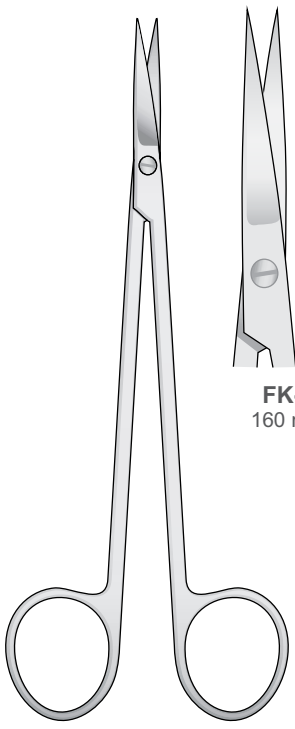


LOCKLIN  
**LK-2**  
160 mm

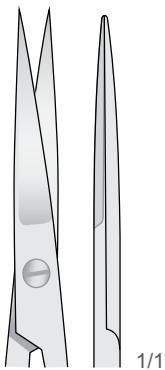


LOCKLIN  
**LK-4**  
160 mm

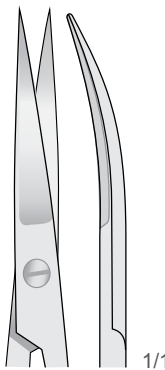
Gezahnt - Serrated  
Dentellata - Dentadas  
Dentelé



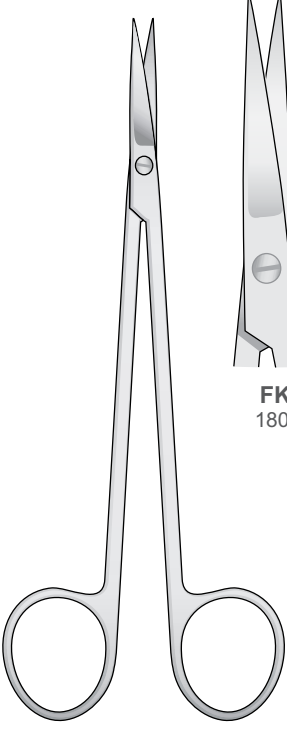
KELLY  
**FK-1/FK-2**  
160 mm



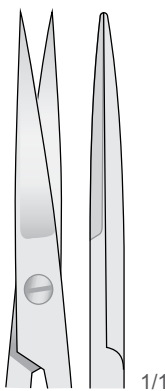
**FK-1**  
160 mm



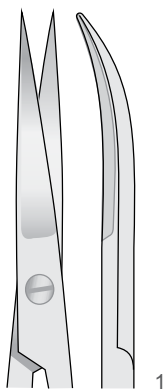
**FK-2**  
160 mm



KELLY  
**FK-87/FK-88**  
180 mm



**FK-87**  
180 mm

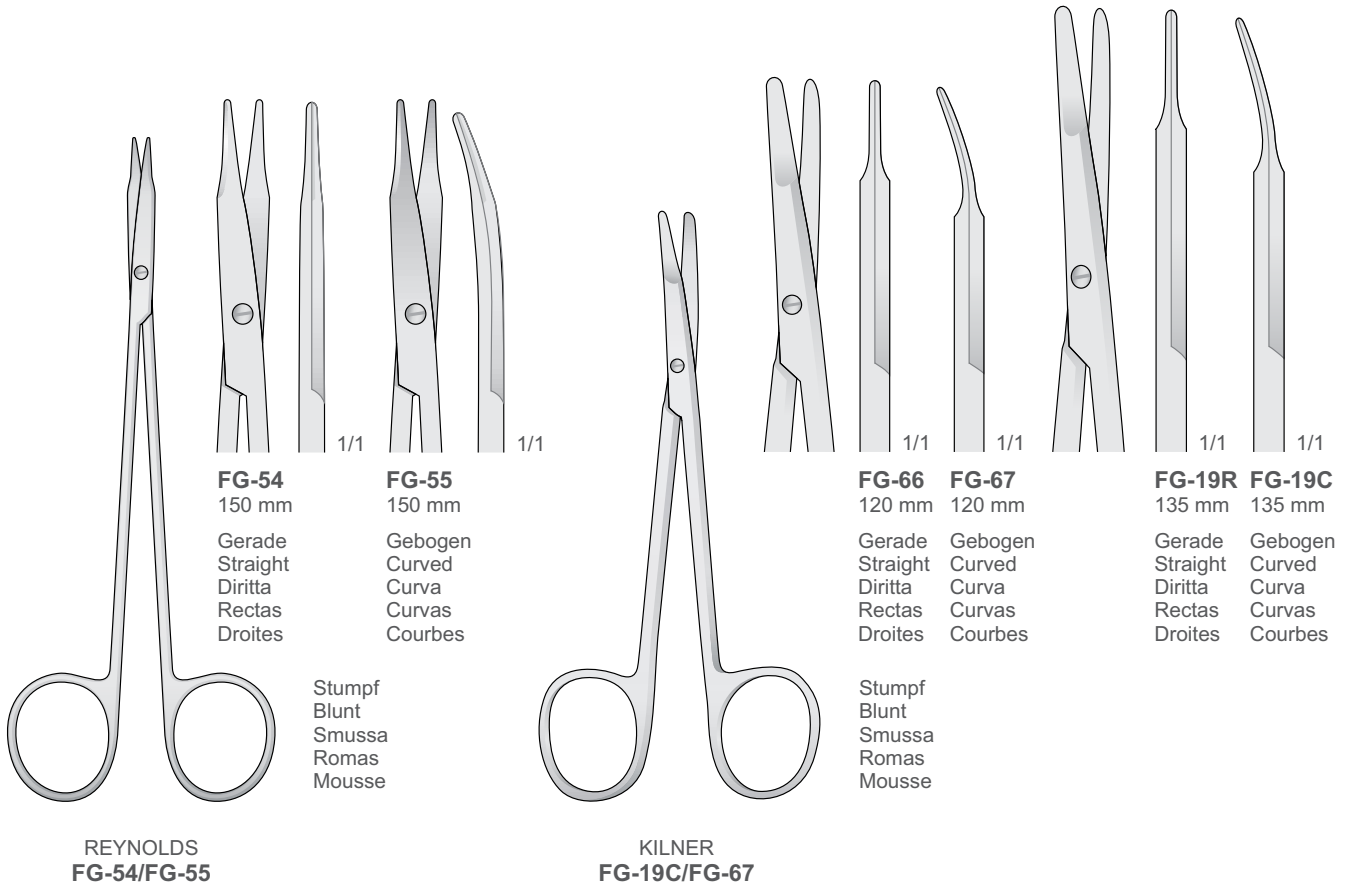
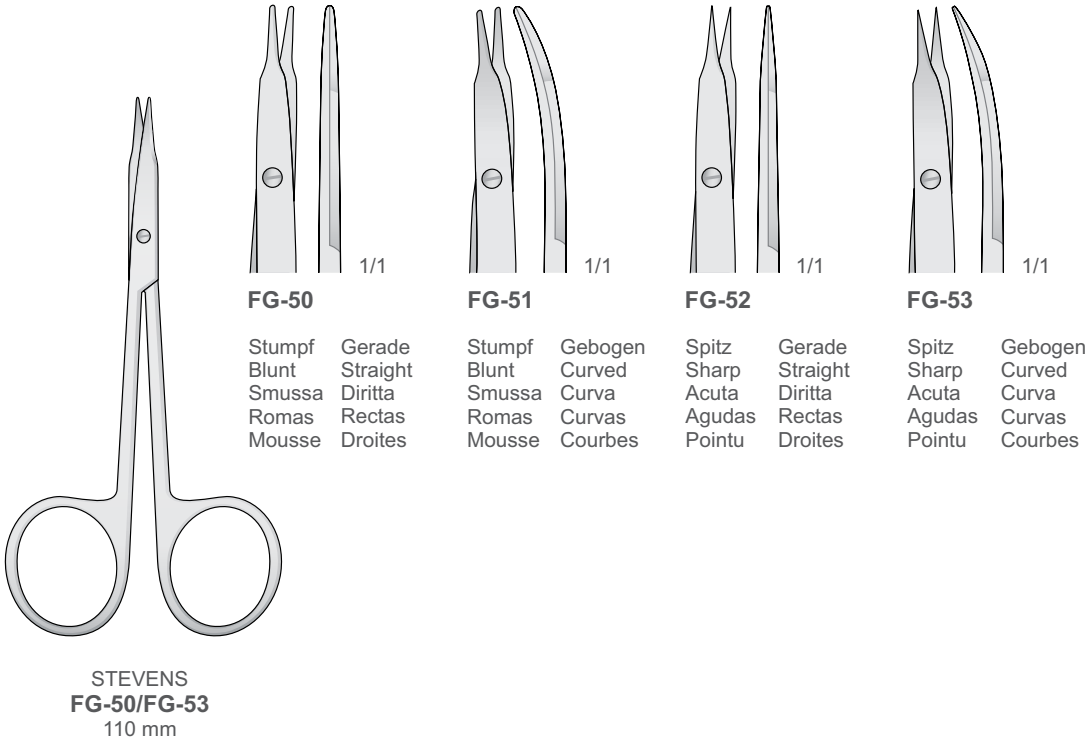


**FK-88**  
180 mm

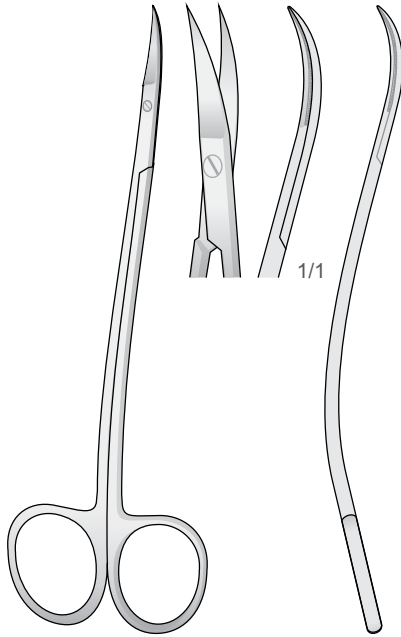


Scheren  
Scissors  
Forbici  
Tijeras  
Ciseaux

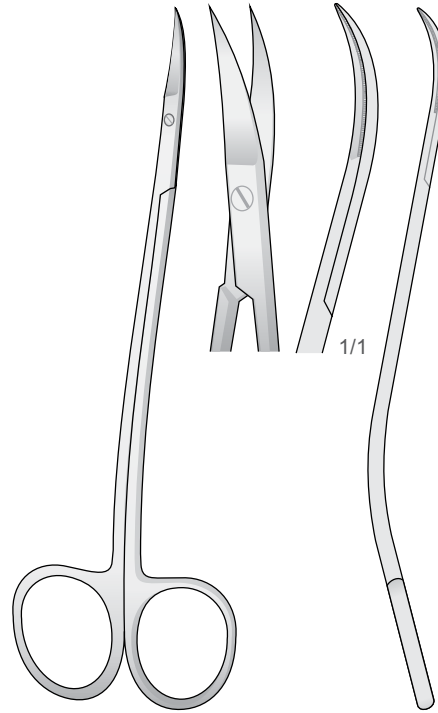
SCISSORS



Gezahnt - Serrated  
Dentellata - Dentadas  
Dentelé

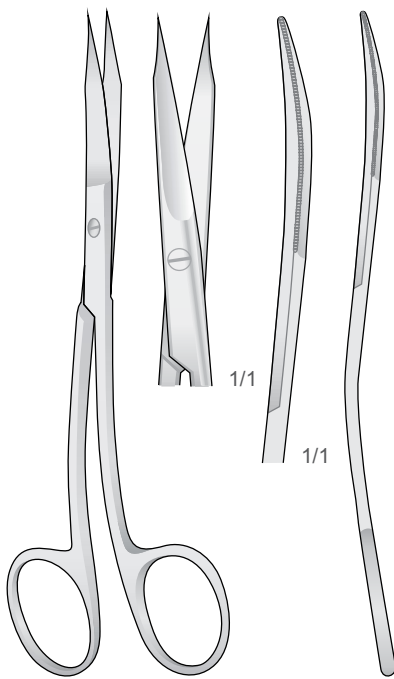


LA GRANGE  
**LG-1**  
115 mm

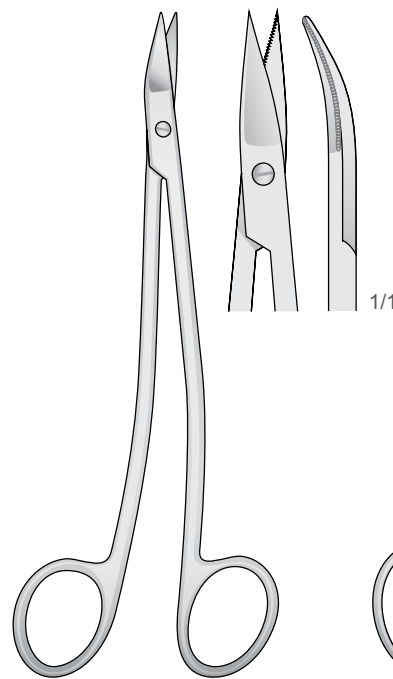


LA GRANGE  
**LG-6**  
155 mm

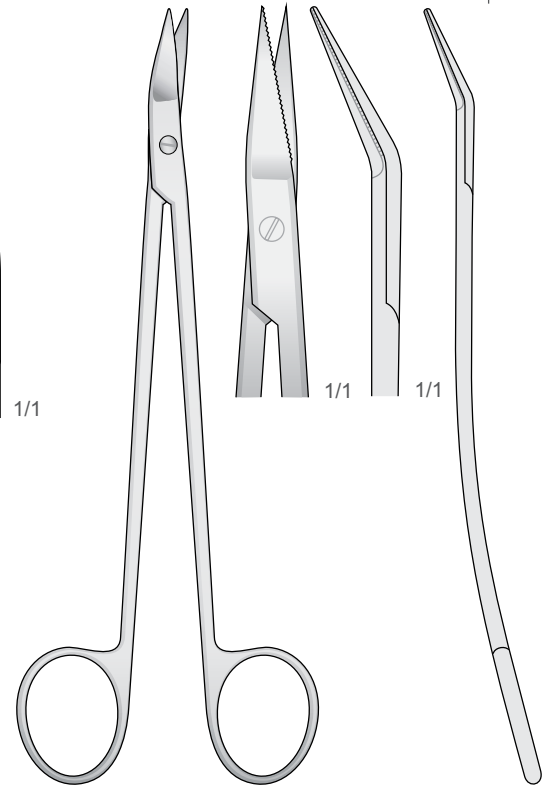
Gezahnt - Serrated  
Dentellata - Dentada  
Dentée



GOLDMAN-FOX S FORM  
**GFS**  
130 mm

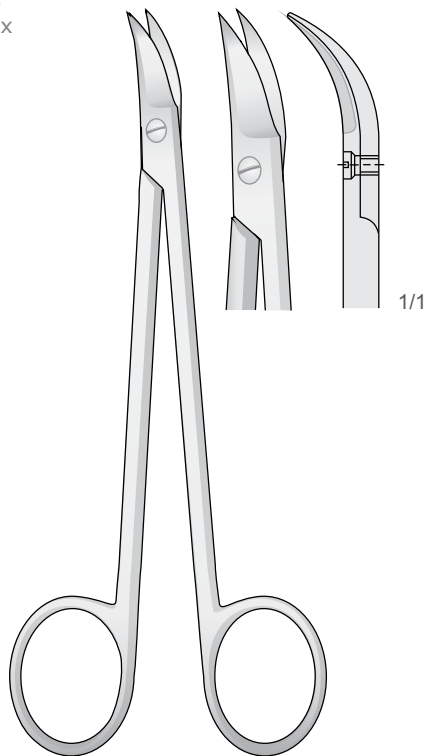


NEUMANN  
**FG-20**  
130 mm

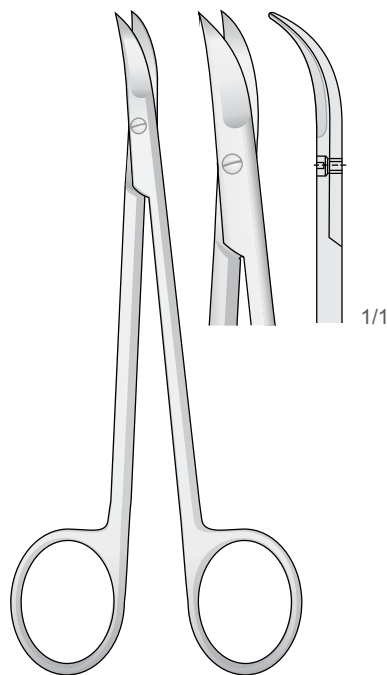


DEAN  
**DEAN**  
180 mm

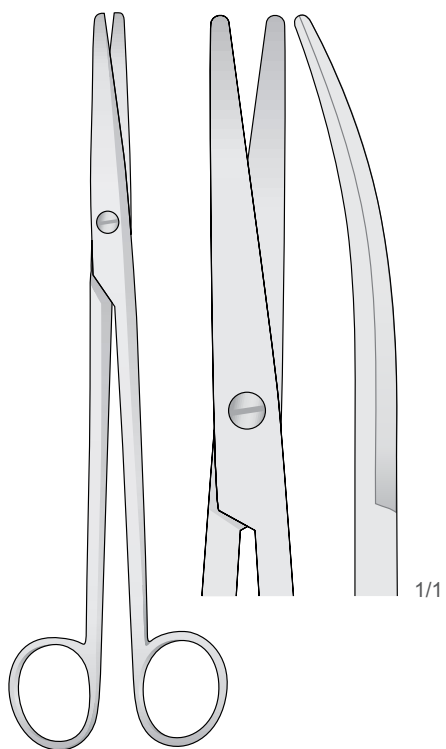
Scheren  
 Scissors  
 Forbici  
 Tijeras  
 Ciseaux



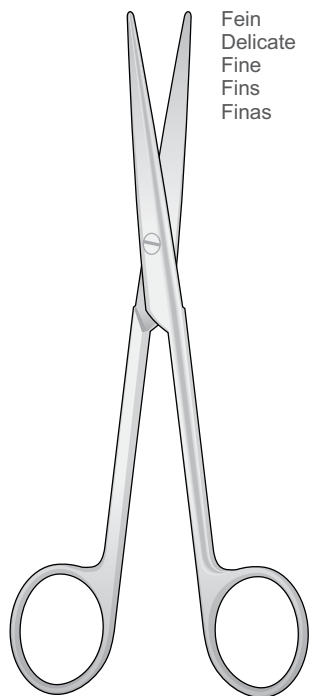
QUINBY  
**FG-38**  
 130 mm



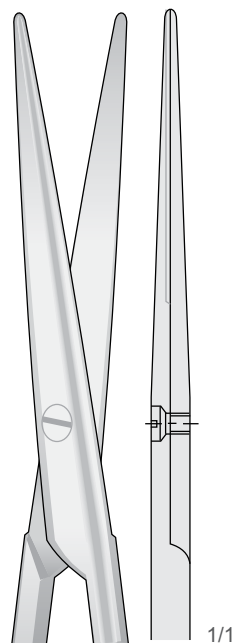
CHADWICK  
**FG-39**  
 115 mm



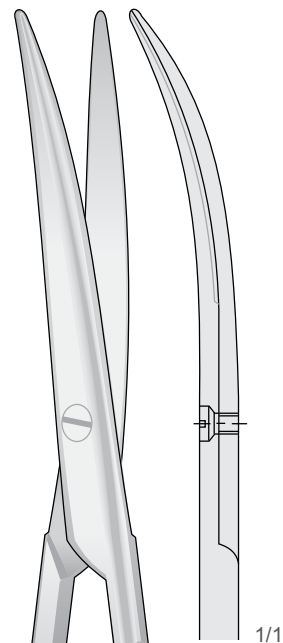
MAYO-LEXER  
**FM-79**  
 165 mm



LEXER  
**FM-180/FM-181**  
 165 mm



**FM-180**



**FM-181**

Fein  
 Delicate  
 Fine  
 Fins  
 Finas

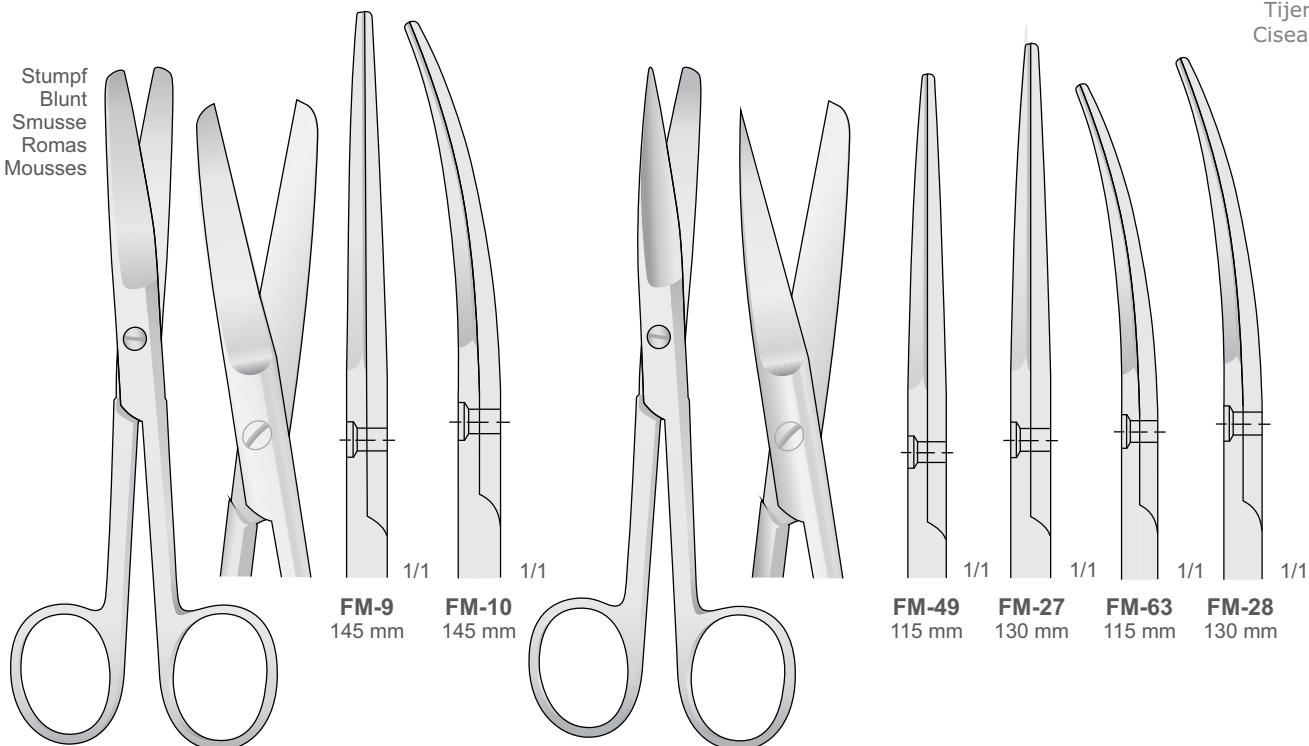
SCISSORS



Scheren  
Scissors  
Forbici  
Tijeras  
Ciseaux

SCISSORS

Stumpf  
Blunt  
Smusse  
Romas  
Mousses



**FM-9**  
145 mm

**FM-10**  
145 mm

**FM-49**  
115 mm

**FM-27**  
130 mm

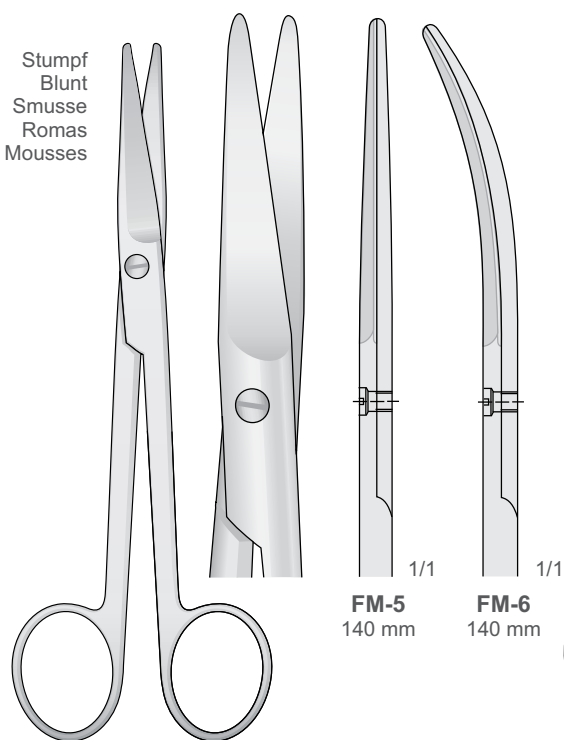
**FM-63**  
115 mm

**FM-28**  
130 mm

**FM-9/FM-10**  
145 mm

**FM-27/FM-63**

Stumpf  
Blunt  
Smusse  
Romas  
Mousses



**FM-5**  
140 mm

**FM-6**  
140 mm

MAYO  
**FM-5/FM-6**  
140 mm

Spitz  
Sharp  
Acute  
Agudo  
Pointu



**FM-41**  
130 mm

**FM-7**  
145 mm

**FM-42**  
130 mm

**FM-8**  
145 mm

**FM-7/FM-42**





Scheren  
Scissors  
Forbici  
Tijeras  
Ciseaux

### SUPER CUT



Regular  
Edge



**SUPER CUT**  
Edge

Super Cut Scissors have specially designed cutting edges.  
One regular edge and **one sharp-knife edge**.

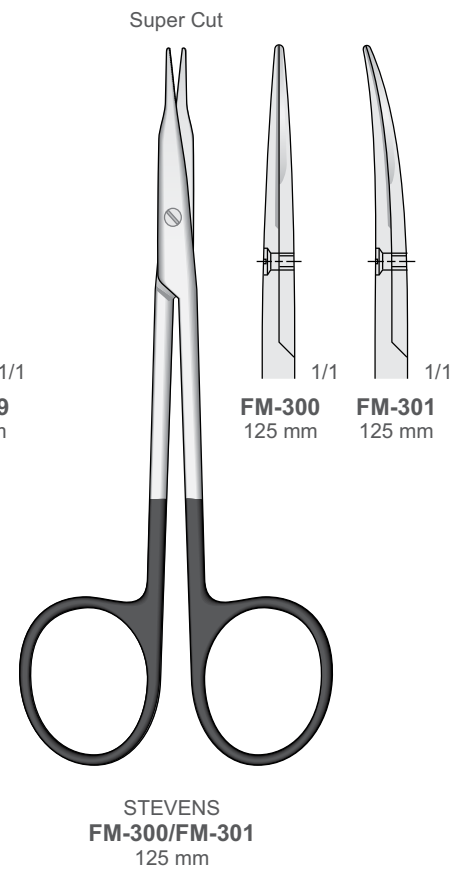
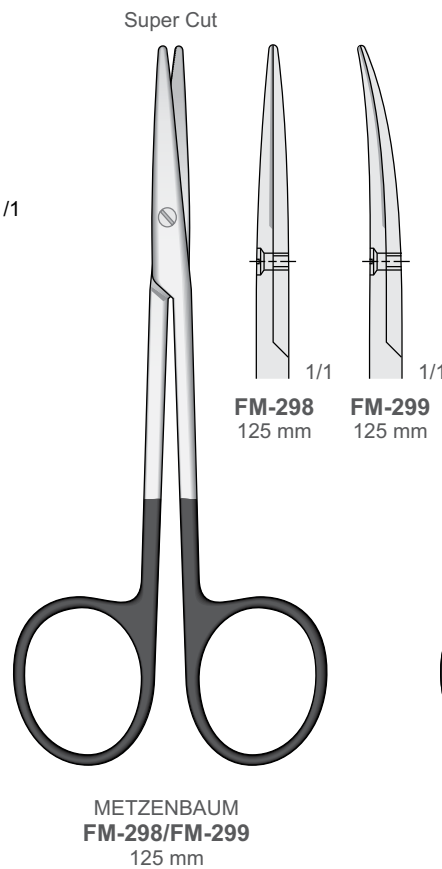
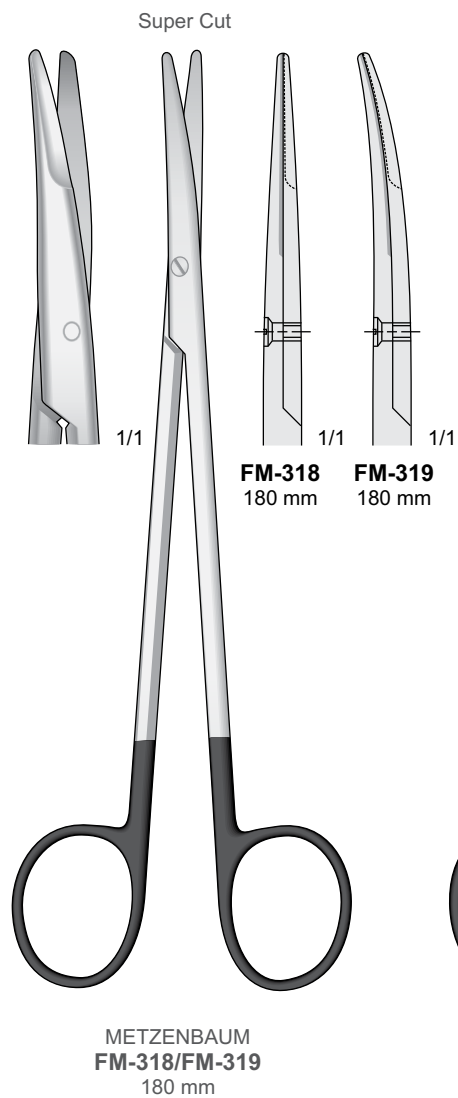


**Extremely Sharp Razor Edge / Atraumatic**  
Extrem Scharfe Spitzer Beck / Atraumatische  
Tranchant extrêmement aiguisée / Atraumatique  
Borde extremadamente afilado / Atraumática  
Taglio estremamente affilato / Atraumatica

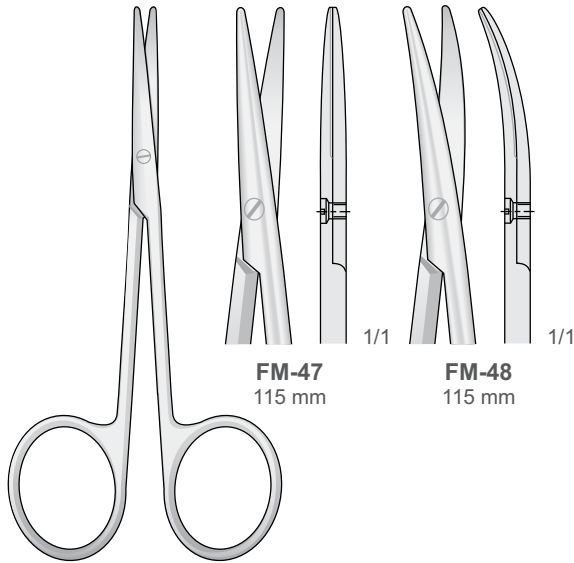


**One side serrated**  
Eine seite gezähnt  
Un côté dentelé  
Un lado dentado  
Un lato dentellato

SCISSORS



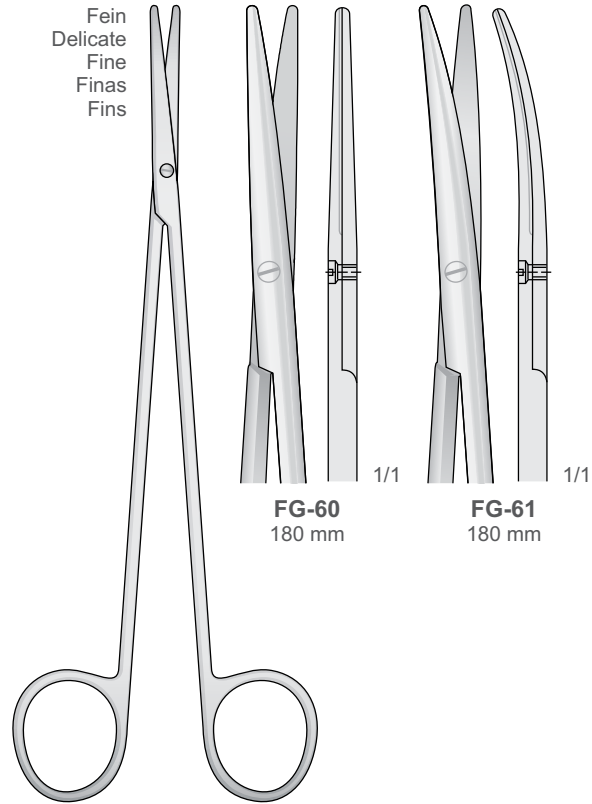
Fein  
Delicate  
Fine  
Finas  
Fins



**FM-47**  
115 mm

**FM-48**  
115 mm

BABY - METZENBAUM  
**FM-47/FM-48**  
115 mm

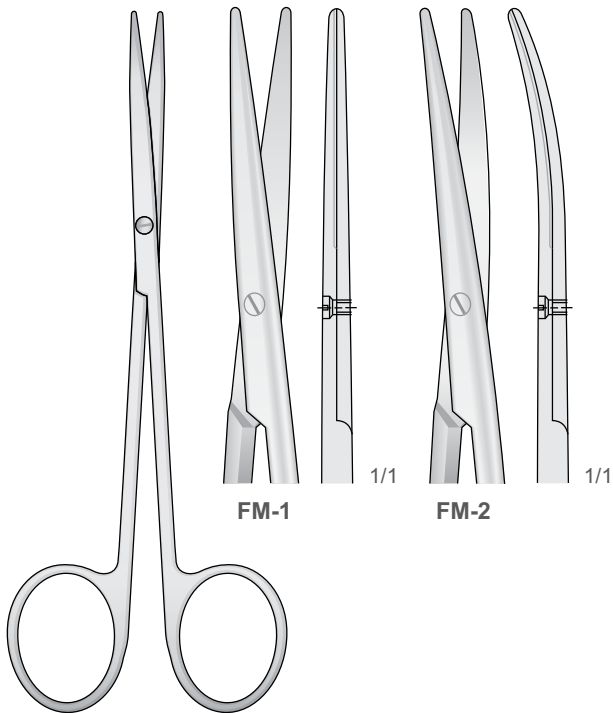


**FG-60**  
180 mm

**FG-61**  
180 mm

TOENNIS-ADSON  
**FG-60/FG-61**  
180 mm

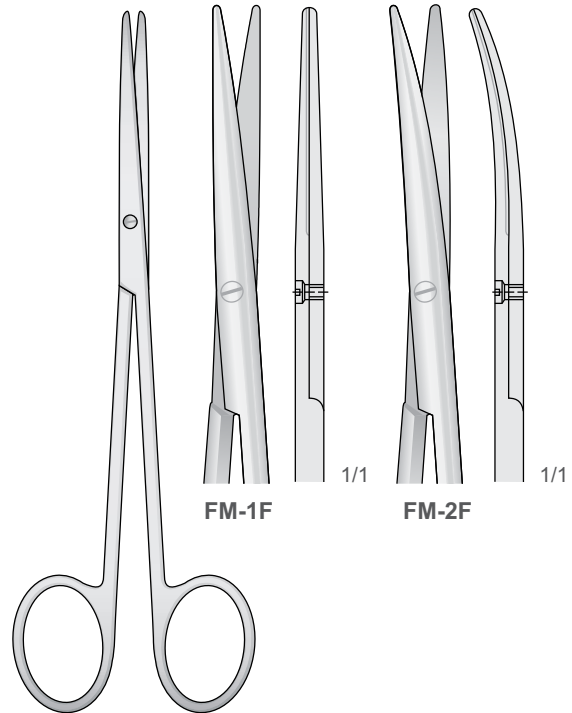
Präparierscheren - Dissecting Scissors  
Forbici per dissezione - Tijeras de disección - Ciseaux à dissection



**FM-1**

**FM-2**

METZENBAUM  
**FM-1/FM-2**  
145 mm

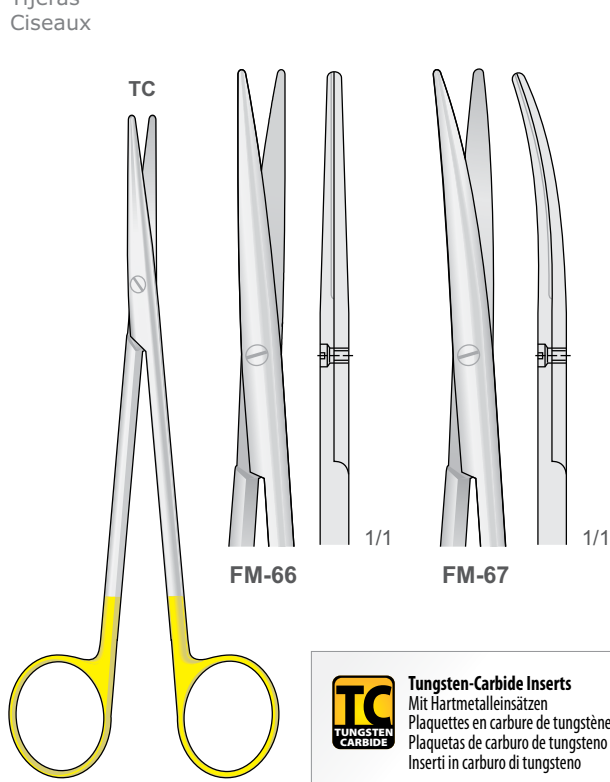


**FM-1F**

**FM-2F**

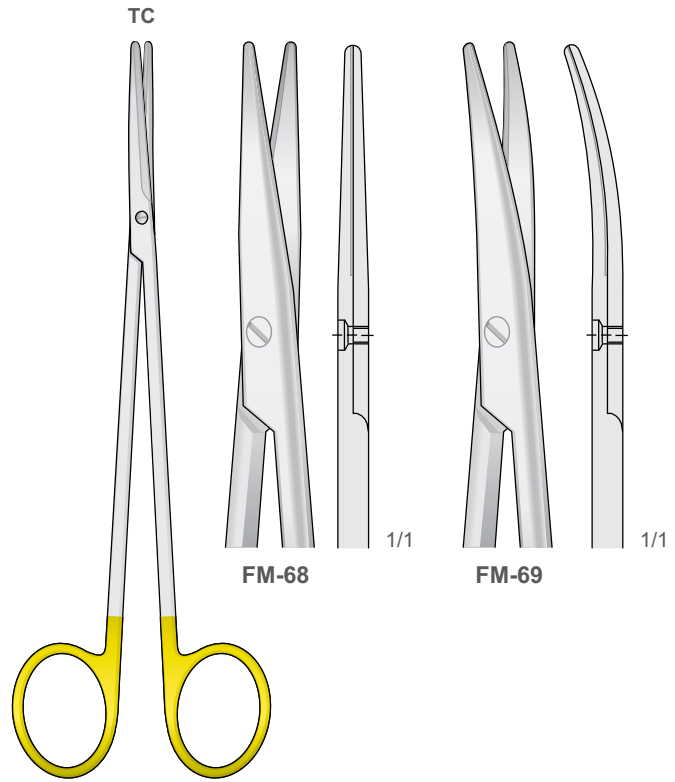
METZENBAUM-FINO  
**FM-1F/FM-2F**  
145 mm

Scheren  
Scissors  
Forbici  
Tijeras  
Ciseaux

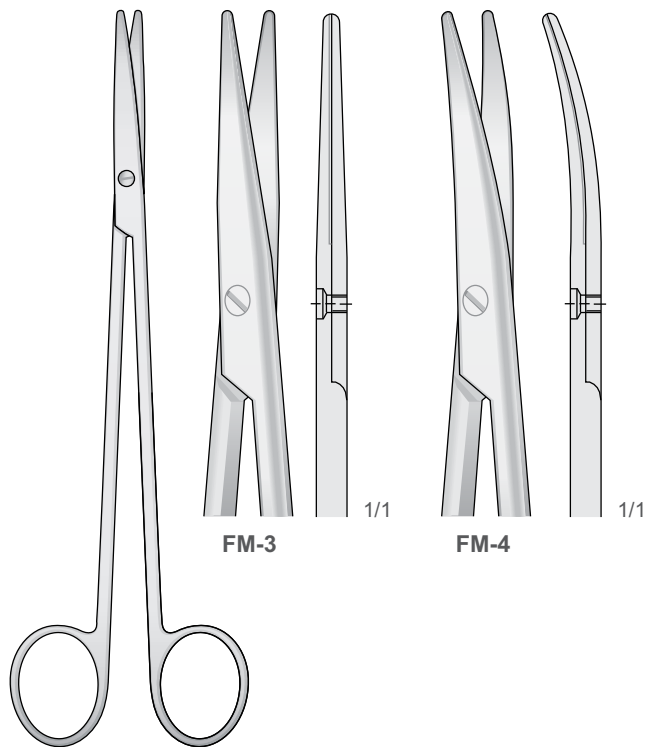


METZENBAUM  
FM-66/FM-67  
145 mm

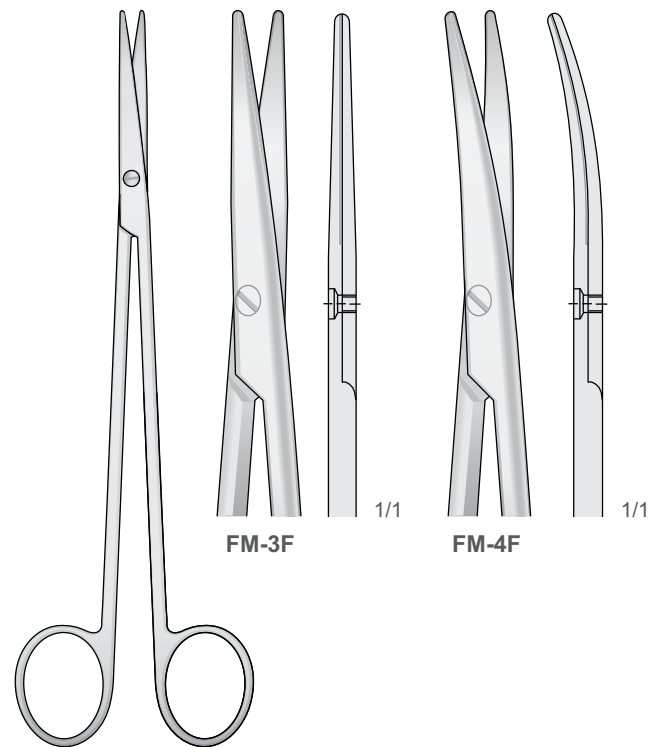
**TC**  
Tungsten-Carbide Inserts  
Mit Hartmetalleinsätzen  
Plaquettes en carbure de tungstène  
Plaquetas de carburo de tungsteno  
Inserti in carburo di tungsteno



METZENBAUM  
FM-68/FM-69  
185 mm



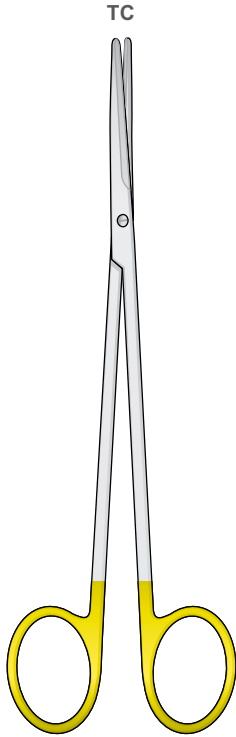
METZENBAUM  
FM-3/FM-4  
185 mm



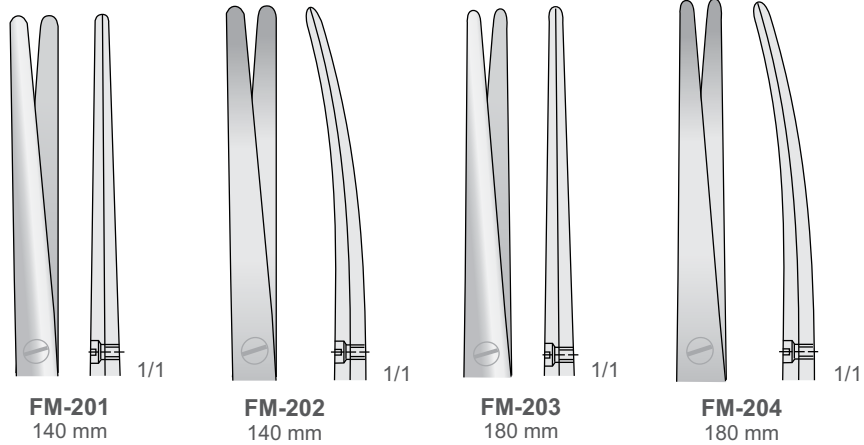
METZENBAUM-FINO  
FM-3F/FM-4F  
185 mm

SCISSORS



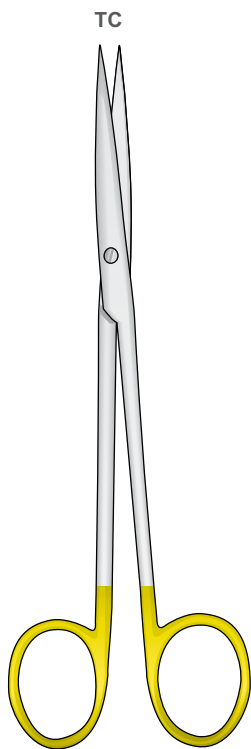


METZENBAUM-FINO  
FM-201/FM-204

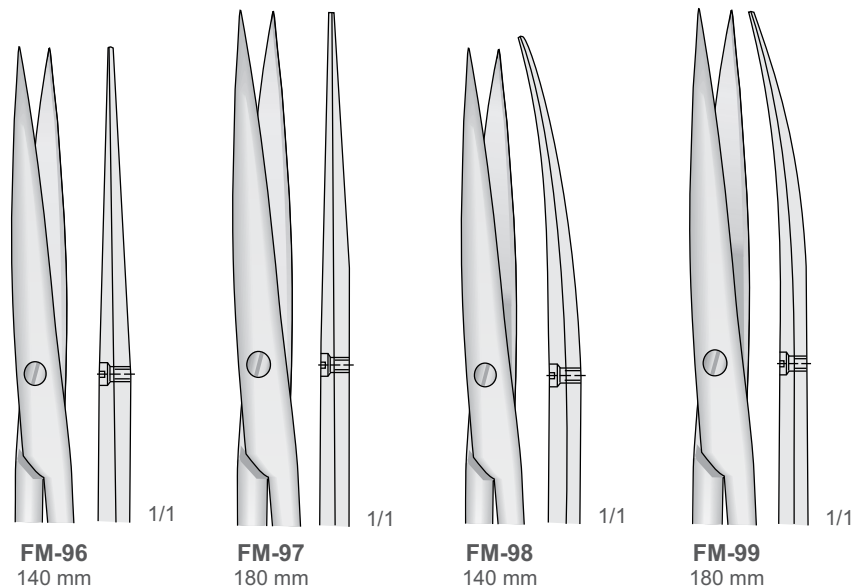


**TC**  
TUNGSTEN  
CARBIDE

**Tungsten-Carbide Inserts**  
Mit Hartmetalleinsätzen  
Plaquettes en carbure de tungstène  
Plaquetas de carburo de tungsteno  
Inserti in carburo di tungsteno



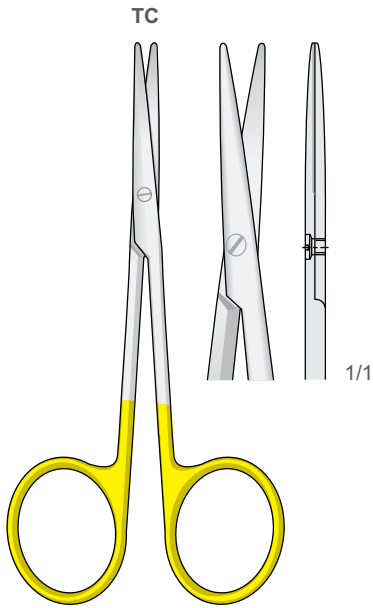
METZENBAUM-FINO  
FM-96/FM-99



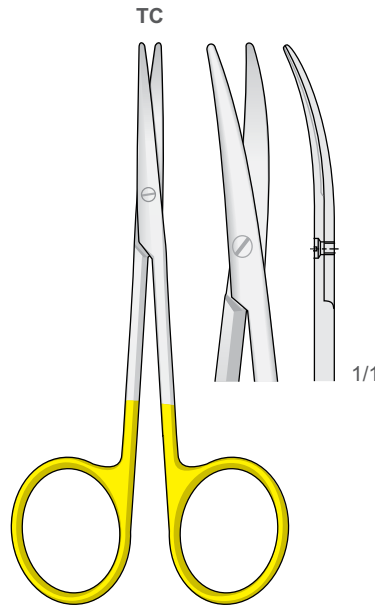
Scheren  
Scissors  
Forbici  
Tijeras  
Ciseaux

**TC**  
TUNGSTEN  
CARBIDE

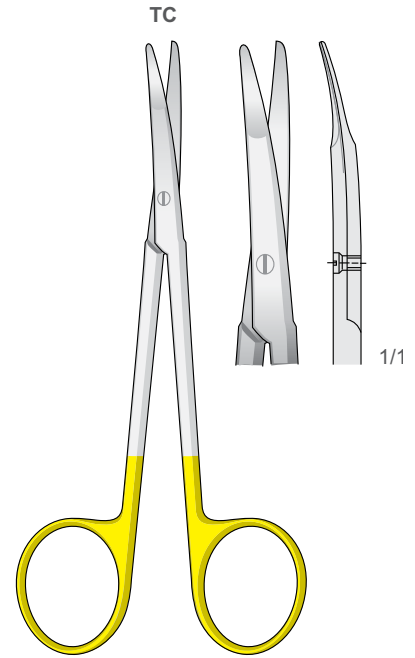
**Tungsten-Carbide Inserts**  
Mit Hartmetalleinsätzen  
Plaquettes en carbure de tungstène  
Plaquetas de carburo de tungsteno  
Inserti in carburo di tungsteno



**BABY-METZENBAUM**  
**FM-118**  
115 mm



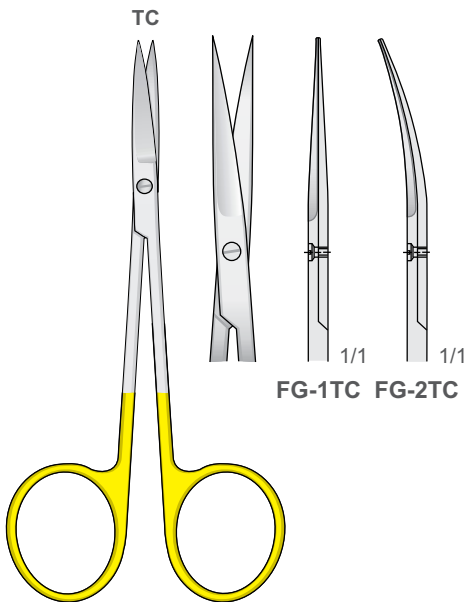
**BABY-METZENBAUM**  
**FM-119**  
115 mm



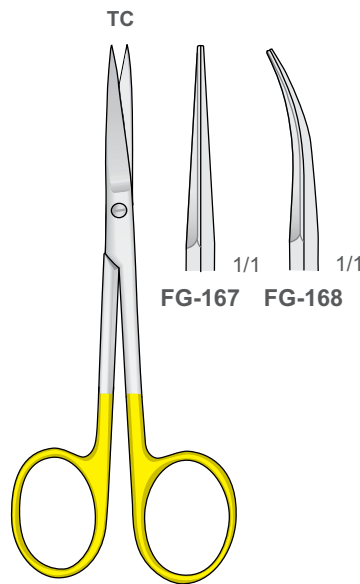
**KILNER**  
**FM-350**  
125 mm

SCISSORS

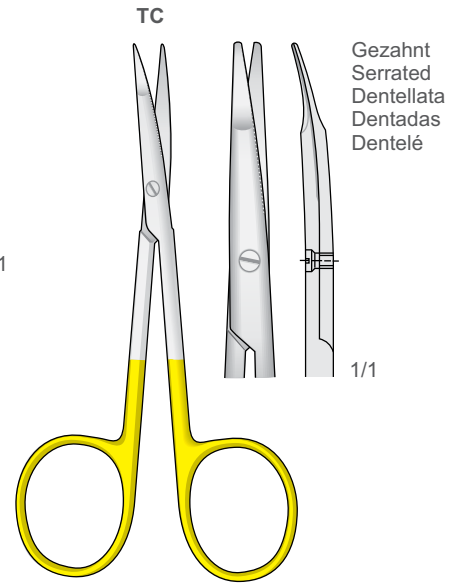
Gebogen - Curved  
Curva - Curvas  
Courbes



**IRIS**  
**FG-1TC/FG-2TC**  
115 mm



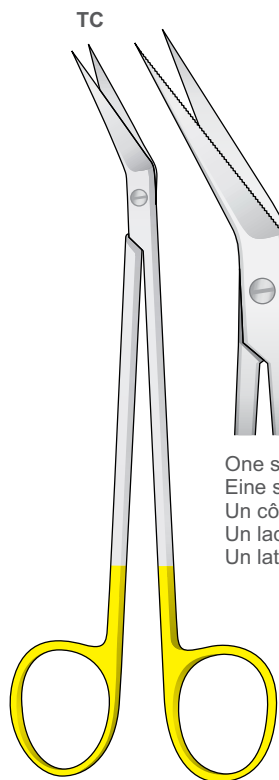
**FG-167/FG-168**  
110 mm



**GREENBERG-PAR**  
**FM-317**  
115 mm

Gezahnt  
Serrated  
Dentellata  
Dentadas  
Dentelé



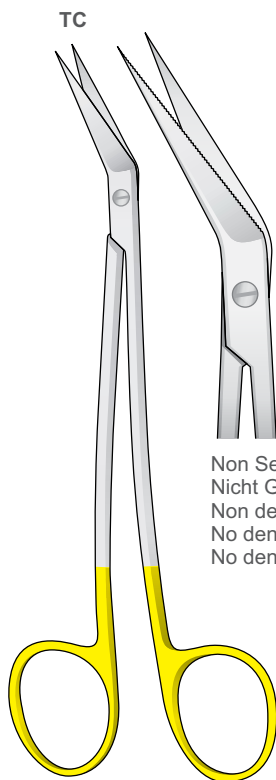


TC

1/1

One side serrated  
Eine seite gezahnt  
Un côté dentelé  
Un lado dentado  
Un lato dentellato

**LK-10**  
160 mm



TC

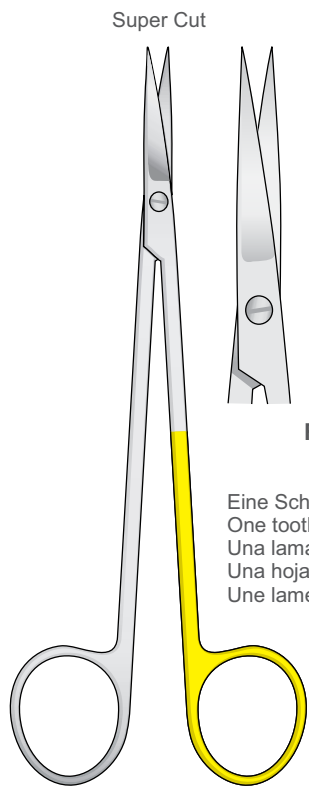
1/1

Non Serrated  
Nicht Gezahnt  
Non dentelé  
No dentado  
No dentellato

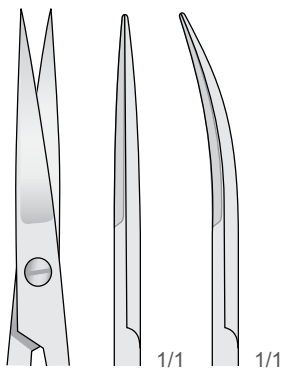
**LK-12**  
160 mm



Eine Schneide gezahnt S-förmig gebogen  
One toothed cutting edge S-shaped  
Una lama dentata curva a forma S  
Una hoja dentada forma S  
Une lame dentelée courbés en S



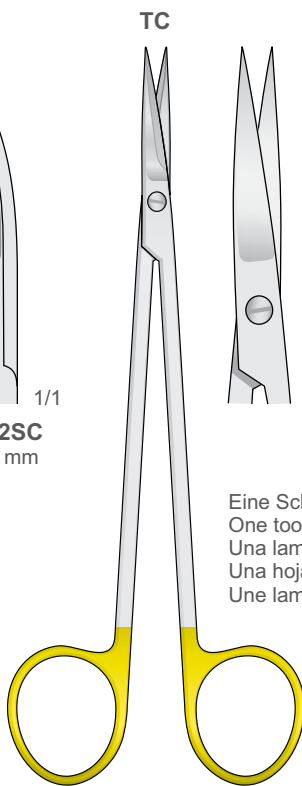
Super Cut



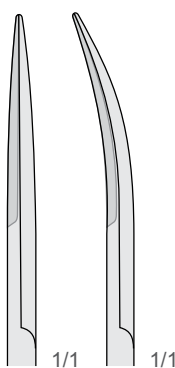
**FK-1SC FK-2SC**  
160 mm 160 mm

Eine Schneide gezahnt  
One toothed cutting  
Una lama dentata  
Una hoja dentada  
Une lame dentelé

**KELLY**  
**FK-1SC/FK-2SC**  
160 mm



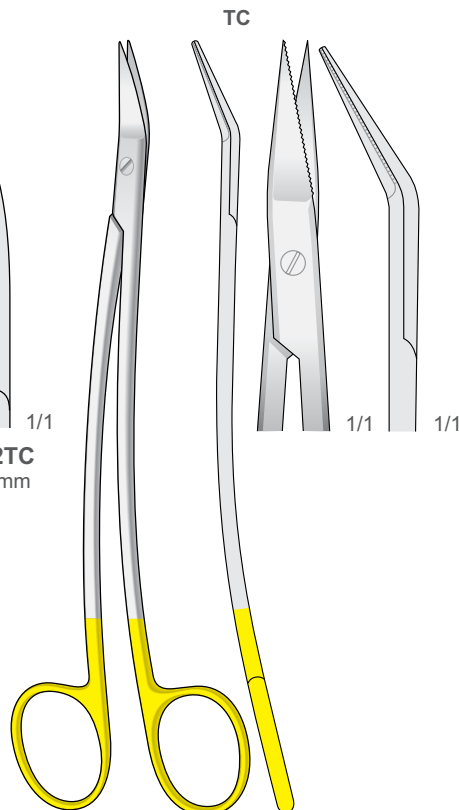
TC



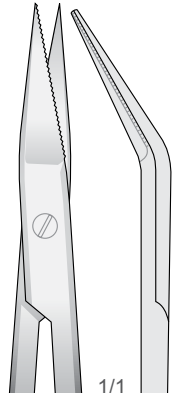
**FK-1TC FK-2TC**  
160 mm 160 mm

Eine Schneide gezahnt  
One toothed cutting  
Una lama dentata  
Una hoja dentada  
Une lame dentelé

**KELLY**  
**FK-1TC/FK-2TC**  
160 mm



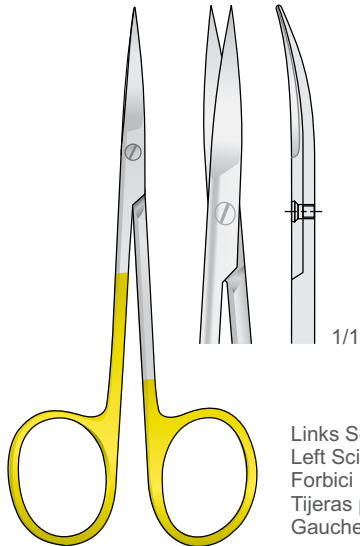
TC



**DEAN-TC**  
175 mm

Scheren  
Scissors  
Forbici  
Tijeras  
Ciseaux

Wellenschliff  
TC



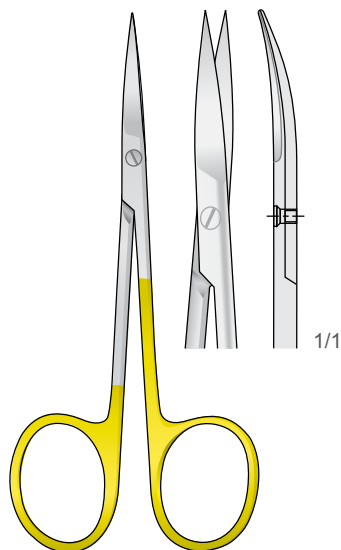
Links Scheren  
Left Scissors  
Forbici per mancini  
Tijeras para zurdos  
Gauche Ciseaux

IRIS  
FM-100L  
110 mm



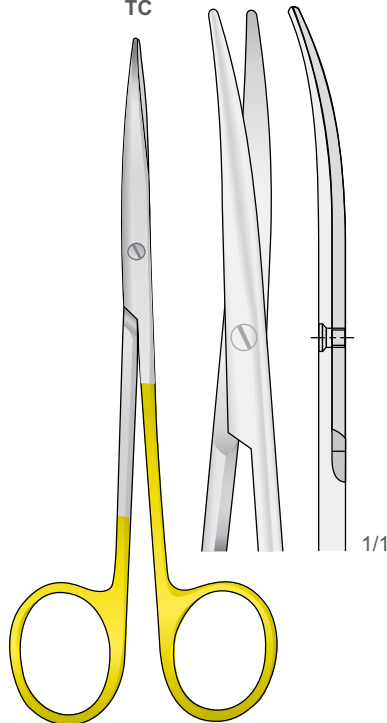
SCISSORS

Wellenschliff  
TC



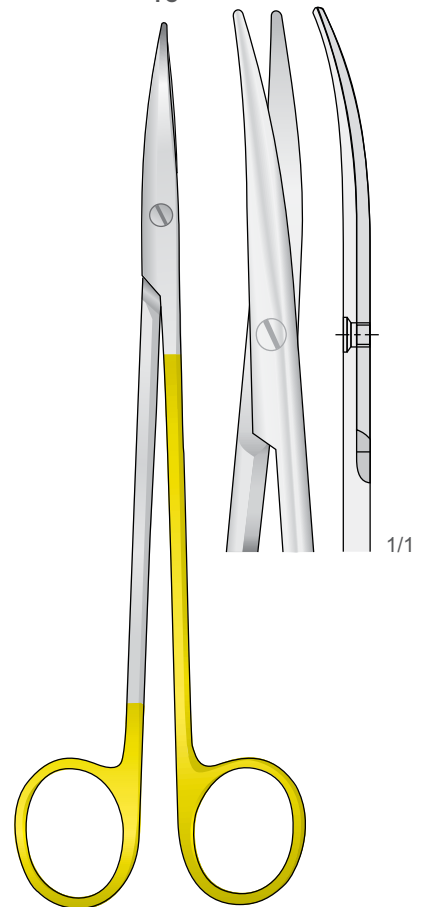
IRIS  
FM-100  
110 mm

Wellenschliff  
TC



METZENBAUM  
FM-102  
145 mm

Wellenschliff  
TC

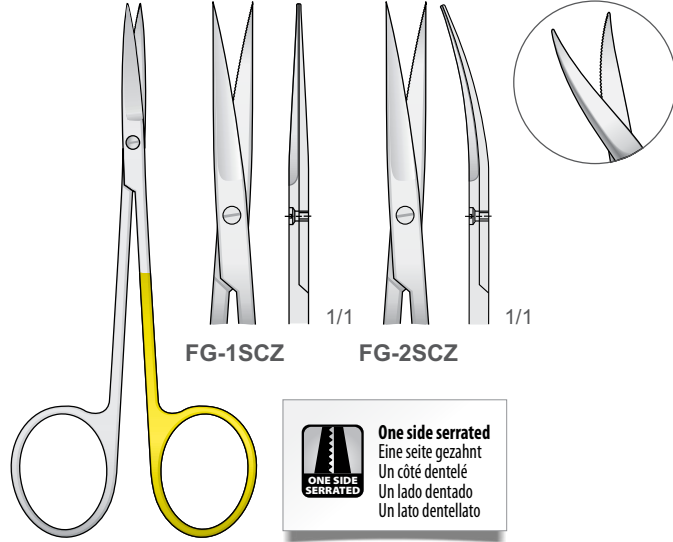


METZENBAUM  
FM-104  
185 mm





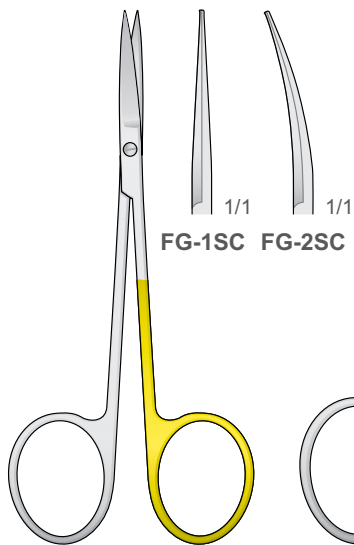
**Extremely Sharp Razor Edge / Atraumatic**  
Extrem Scharfe Spitzer Beck / Atraumatische  
Tranchant extrêmement aiguisée / Atraumatische  
Borde extremadamente afilado / Atraumática  
Taglio estremamente affilato / Atraumatica



**FG-1SCZ FG-2SCZ**

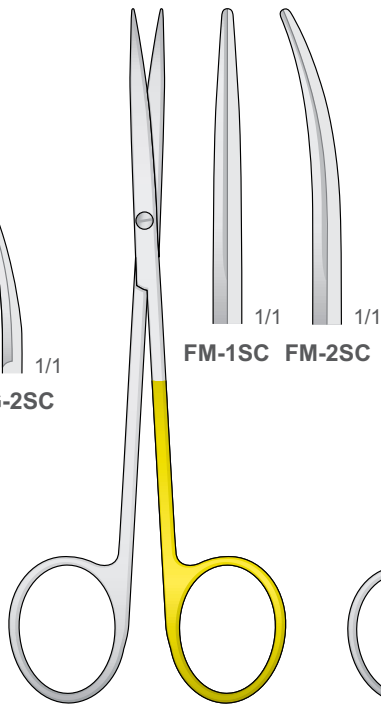
**ONE SIDE SERRATED**  
**One side serrated**  
Eine seite gezahnt  
Un côté dentelé  
Un lado dentado  
Un lato dentellato

**FG-1SCZ/FG-2SCZ**  
110 mm



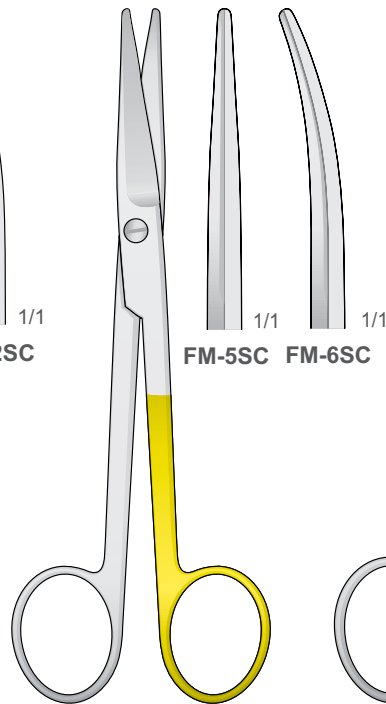
**FG-1SC FG-2SC**

**IRIS**  
**FG-1SC/FG-2SC**  
110 mm



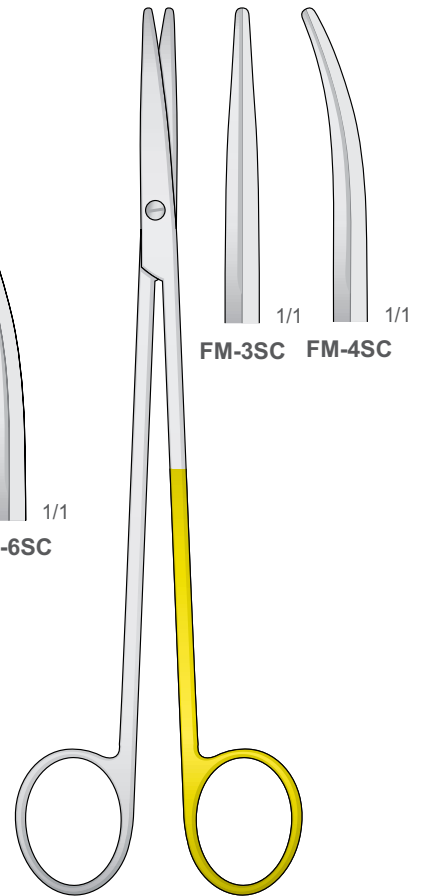
**FM-1SC FM-2SC**

**METZENBAUM**  
**FM-1SC/FM-2SC**  
145 mm



**FM-5SC FM-6SC**

**MAYO**  
**FM-5SC/FM-6SC**  
140 mm




**FM-3SC FM-4SC**

**METZENBAUM**  
**FM-3SC/FM-4SC**  
185 mm






**SUPER CUT**




Regular  
Edge




**SUPER CUT**  
Edge

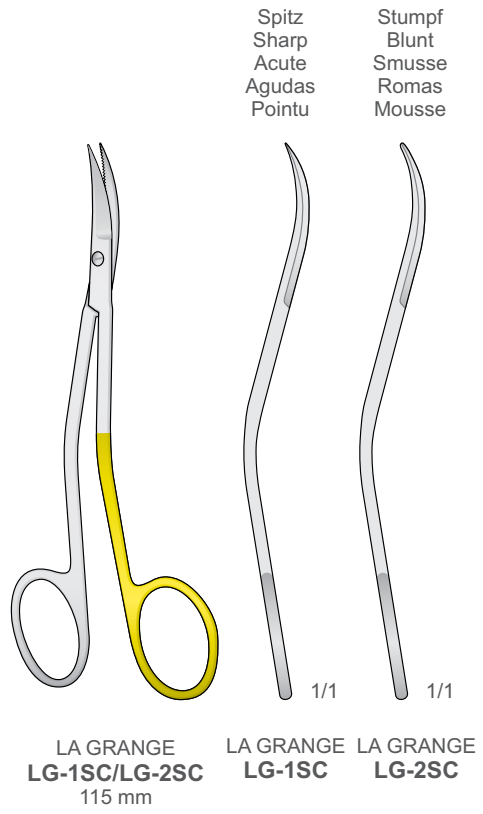
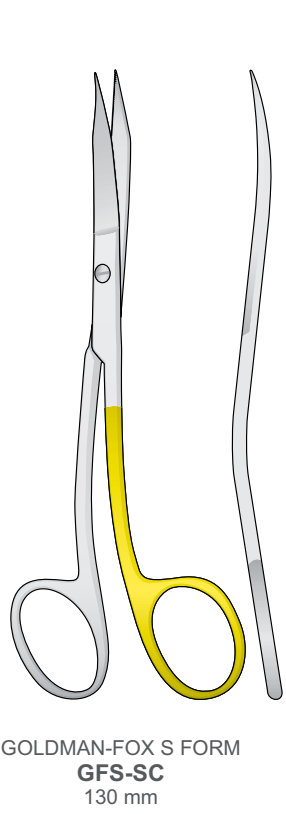
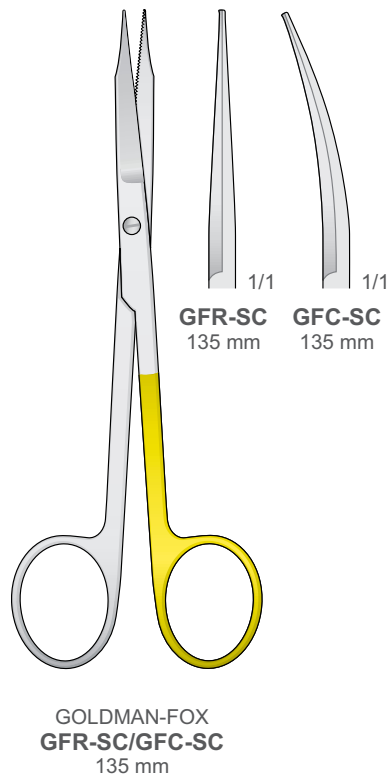
Super Cut Scissors have specially designed cutting edges.  
One regular edge and **one sharp-knife edge**.

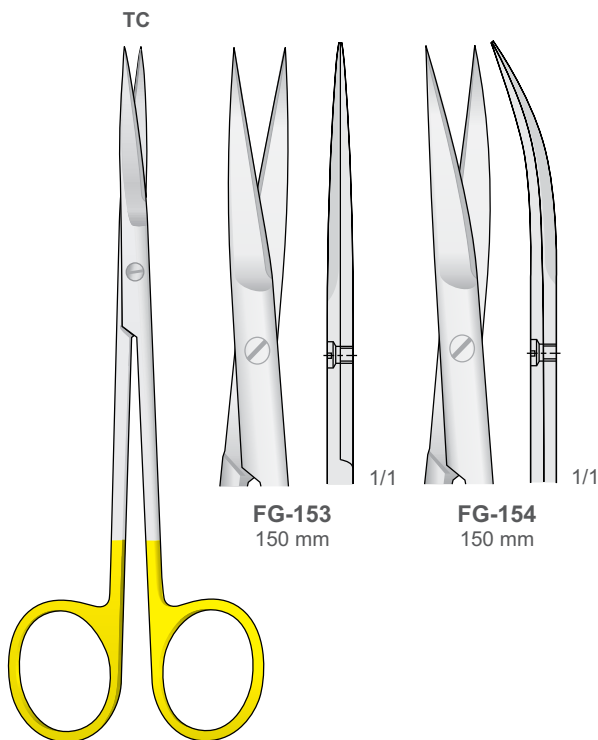


**Extremely Sharp Razor Edge / Atraumatic**  
Extrem Scharfe Spitzer Beck / Atraumatische  
Tranchant extrêmement aiguisée / Atraumatique  
Borde extremadamente afilado / Atraumática  
Taglio estremamente affilato / Atraumatica



**One side serrated**  
Eine seite gezahnt  
Un côté dentelé  
Un lado dentado  
Un lato dentellato





JOSEPH  
FG-153/FG-154  
150 mm



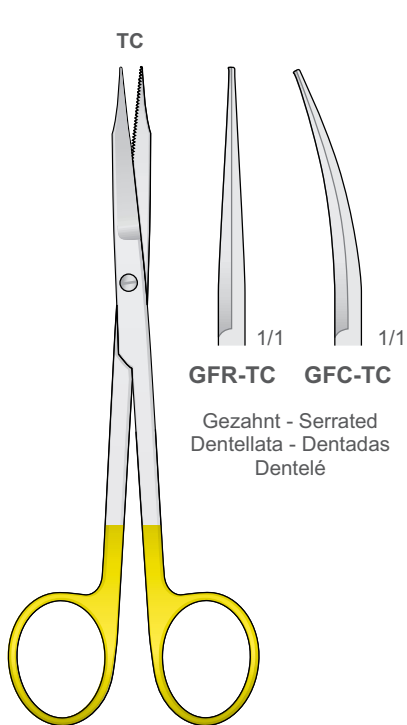
**Tungsten-Carbide Inserts**  
Mit Hartmetalleinsätzen  
Plaquettes en carbure de tungstène  
Plaquetas de carburo de tungsteno  
Inserti in carburo di tungsteno



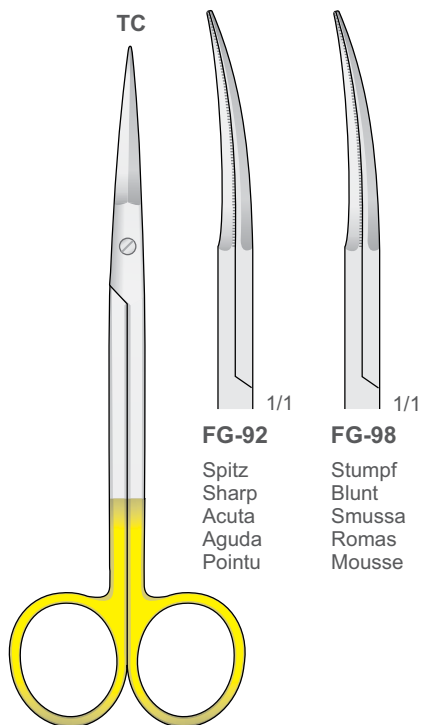
**One side serrated**  
Eine seite gezahnt  
Un côté dentelé  
Un lado dentado  
Un lato dentellato



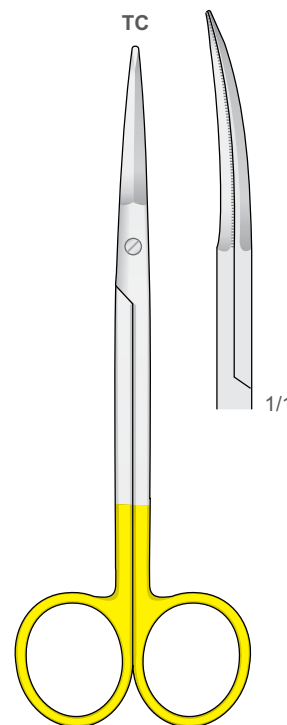
**One side serrated**  
Eine seite gezahnt  
Un côté dentelé  
Un lado dentado  
Un lato dentellato



GOLDMAN-FOX  
GFC-TC/GFR-TC  
135 mm

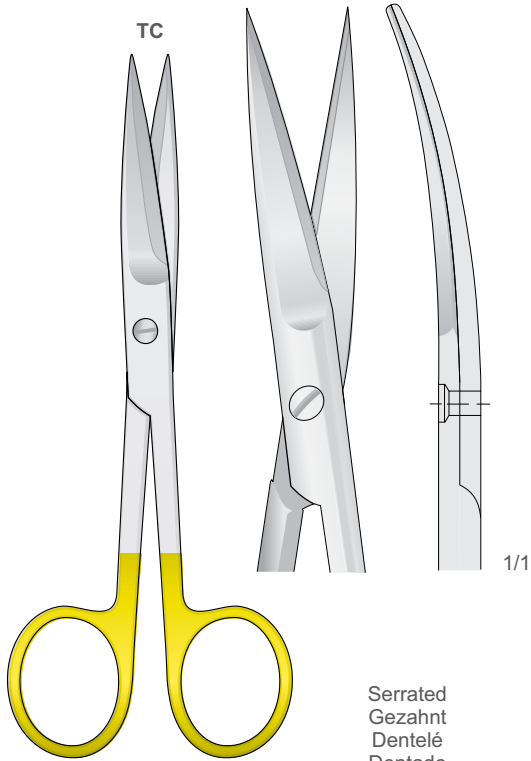


PECK-JOSEPH  
FG-92/FG-98  
140 mm




GREGORY  
FM-339  
140 mm

Scheren  
Scissors  
Forbici  
Tijeras  
Ciseaux



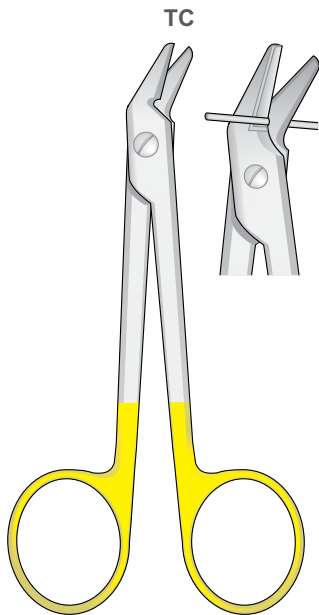
Serrated  
Gezahnt  
Dentelé  
Dentado  
Dentellato

**FM-146**  
145 mm

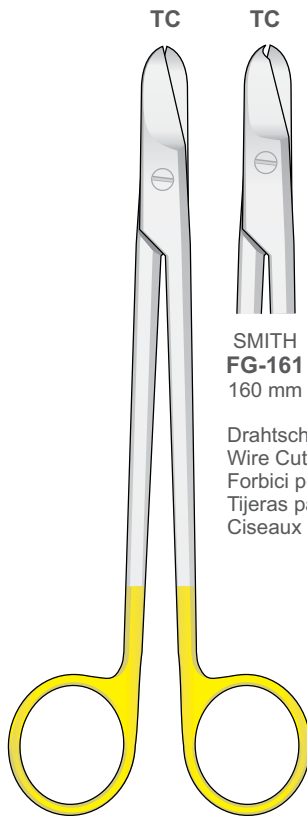


**Tungsten-Carbide Inserts**  
Mit Hartmetalleinsätzen  
Plaquettes en carbure de tungstène  
Plaquetas de carburo de tungsteno  
Inserti in carburo di tungsteno

SCISSORS



**DP-120**  
120 mm

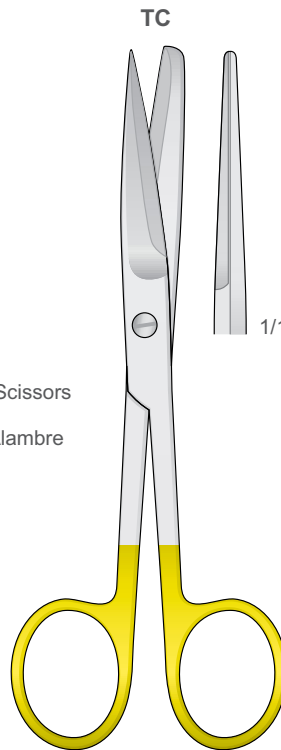


**SMITH  
FG-160**  
160 mm

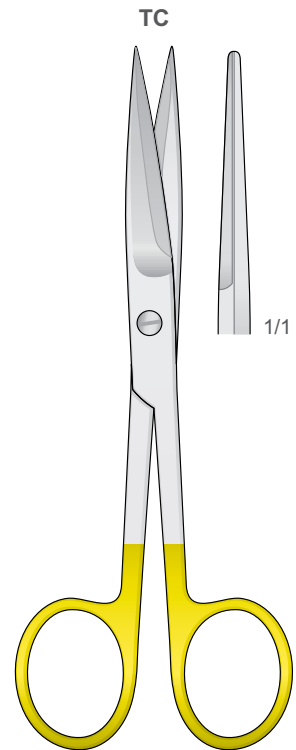


**SMITH  
FG-161**  
160 mm

Drahtschere  
Wire Cutting Scissors  
Forbici per fili  
Tijeras para Alambre  
Ciseaux à fils



**FM-51**  
145 mm

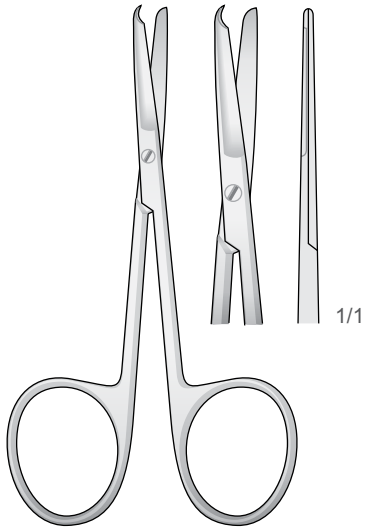


**FM-59**  
145 mm

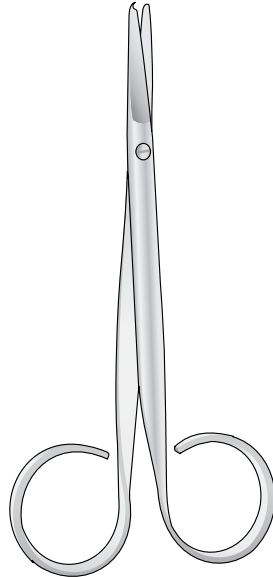


Ligatur Scheren  
Ligature Scissors  
Forbici per legature  
Tijeras para ligaduras  
Ciseaux à ligatures

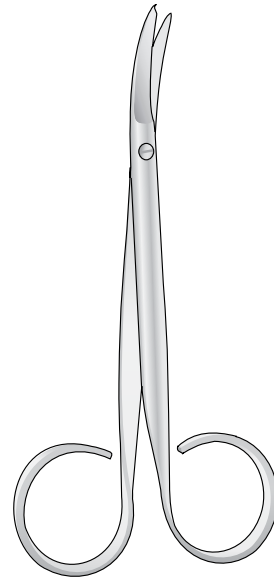
SCISSORS



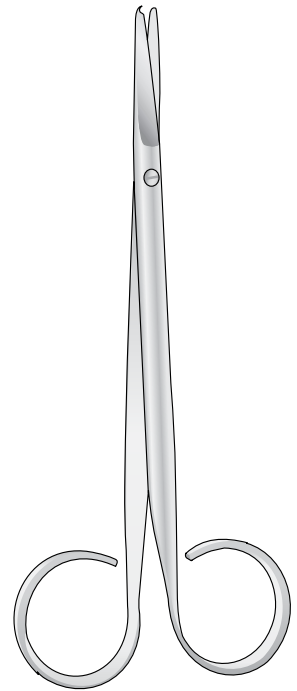
SPENCER  
**SC-9**  
90 mm



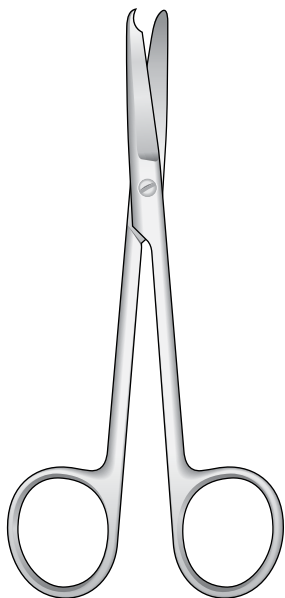
SPENCER  
**SC-1**  
110 mm



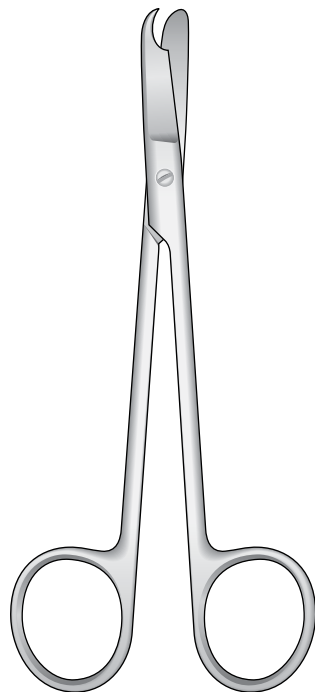
SPENCER  
**SC-5**  
110 mm



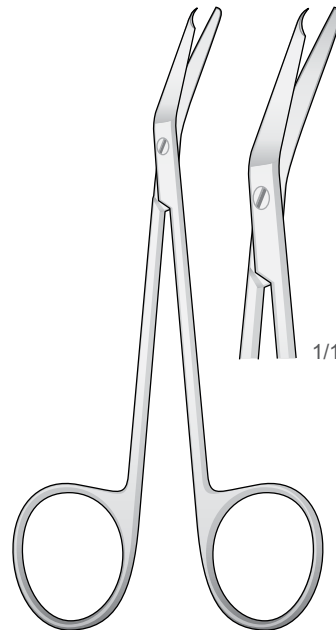
SPENCER  
**SC-2**  
145 mm



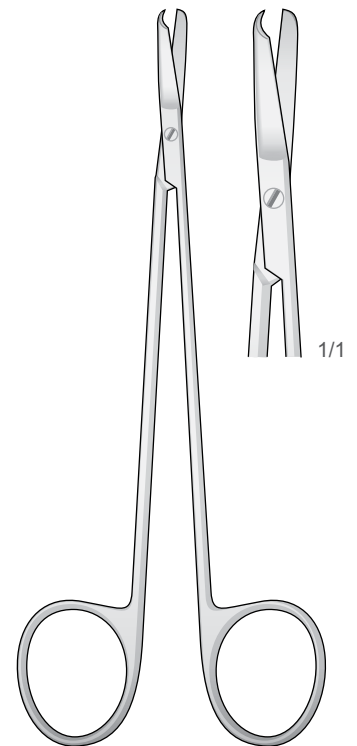
SPENCER  
**SC-14**  
120 mm



LITTAUER  
**SC-15**  
140 mm



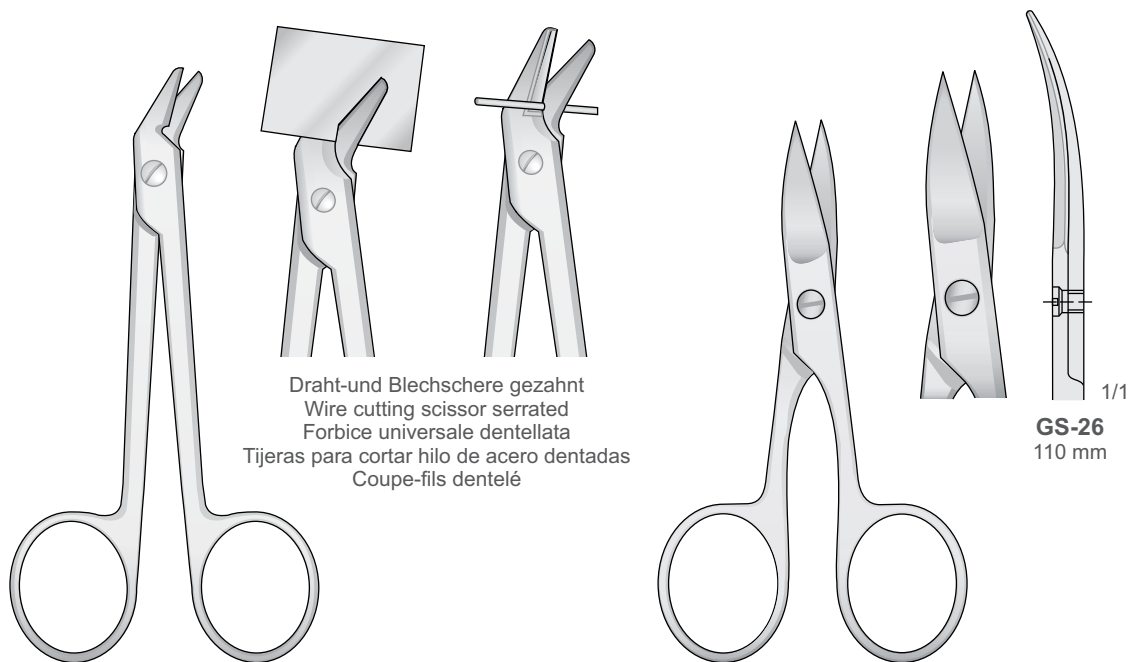
SPENCER  
**SC-13**  
130 mm



KELLY  
**SC-16**  
150 mm



Draht und blechscheren  
 Wire and plate cutting scissors  
 Forbici per fili metallici  
 Tijeras para cortar alambre  
 Ciseaux coupe-fils métalliques



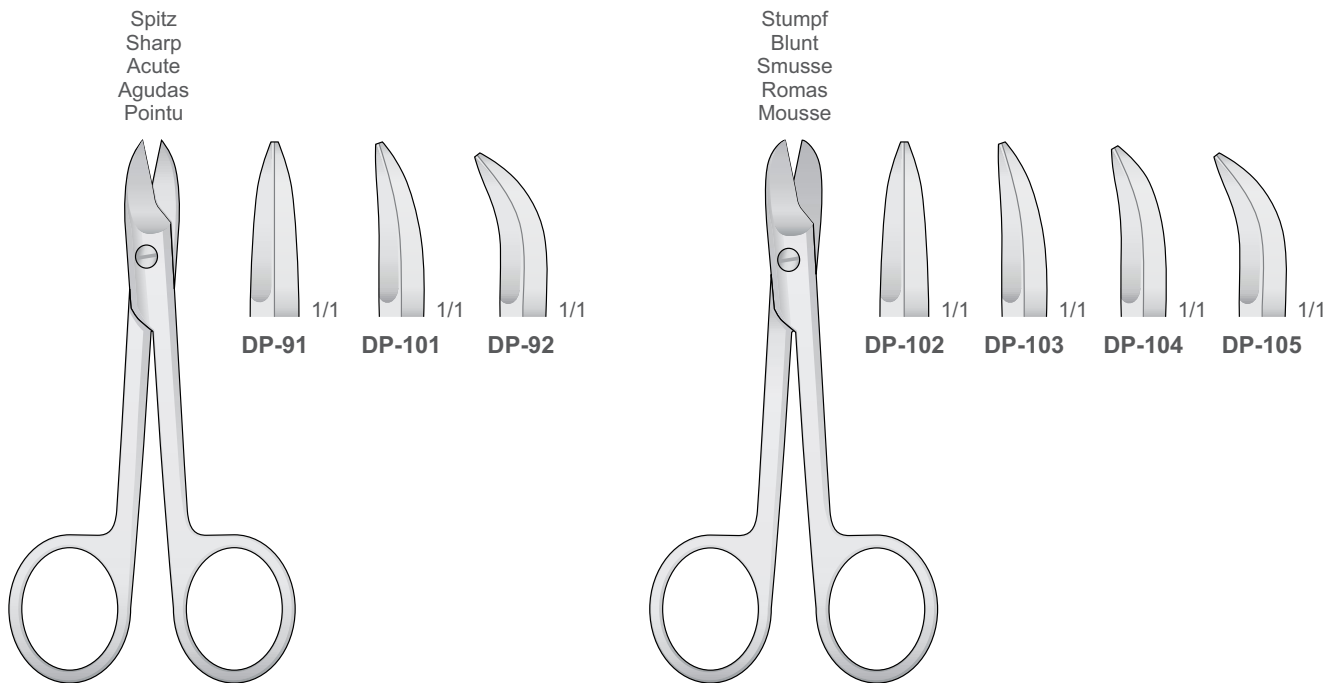
Draht-und Blechschere gezahnt  
 Wire cutting scissor serrated  
 Forbice universale dentellata  
 Tijeras para cortar hilo de acero dentadas  
 Coupe-fils dentelé

GS-26  
 110 mm

DP-90  
 120 mm

GS-26  
 110 mm

SCISSORS



Spitz  
 Sharp  
 Acute  
 Agudas  
 Pointu

Stumpf  
 Blunt  
 Smusse  
 Romas  
 Mousse

DP-91

DP-101

DP-92

DP-102

DP-103

DP-104

DP-105

BEEBE  
 DP-91/DP-101  
 110 mm

BEEBE  
 DP-102/DP-105  
 110 mm







we take a closer look

# + TWEEZERS



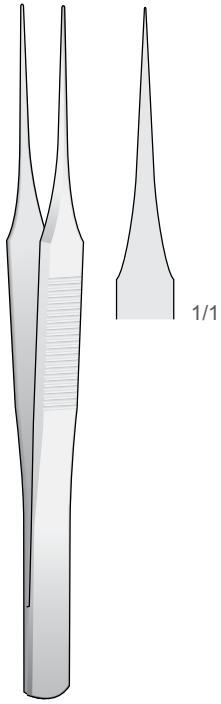
Micro Forceps  
Titanium Forceps  
Dressing Forceps  
Endo Forceps  
Tissue Forceps  
STC/ Forceps / Atraumatic  
Membrane





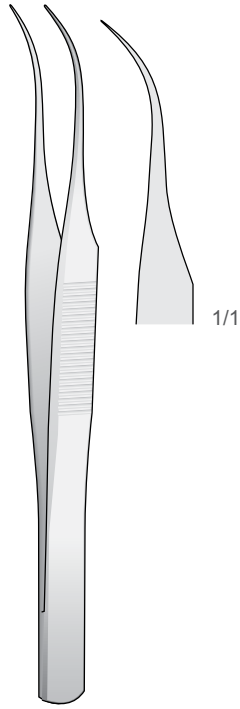
Mikro Pinzetten  
 Delicate Forceps  
 Micro Pinzette  
 Pinzas finas  
 Micro Pincas

0,2 mm



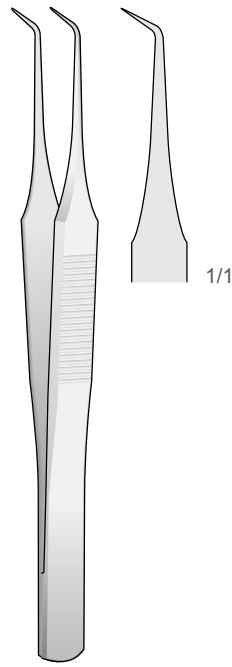
**BD-360**  
110 mm

0,3 mm



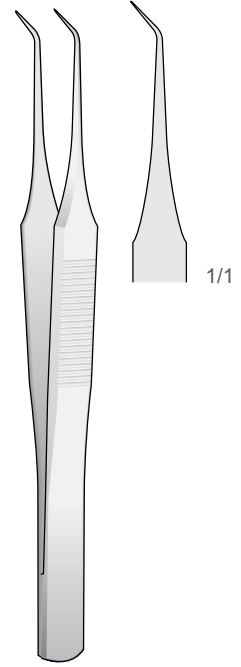
**BD-361**  
110 mm

0,25 mm



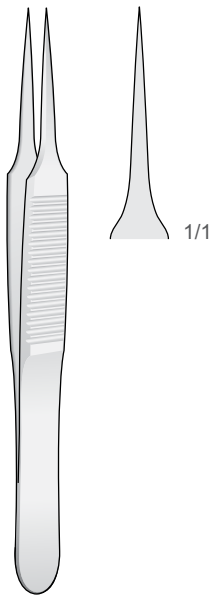
**BD-362**  
100 mm

0,15 mm



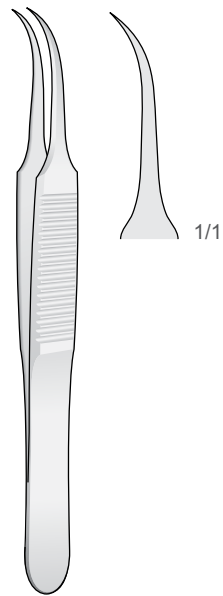
**BD-363**  
100 mm

0,4 mm



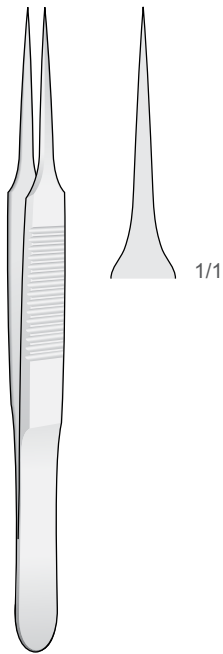
**BD-364**  
110 mm

0,4 mm



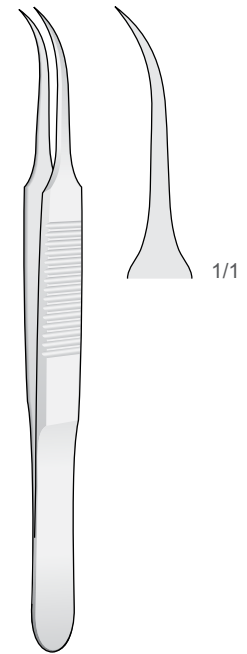
**BD-365**  
110 mm

0,4 mm



**BD-366**  
130 mm

0,4 mm



**BD-367**  
130 mm

TWEEZERS

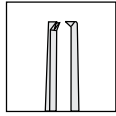


Mikro Pinzetten  
Delicate Forceps  
Micro Pinzette  
Pinzas finas  
Micro Pincers



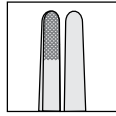
TWEEZERS

Tissue Forceps  
1x2 Teeth

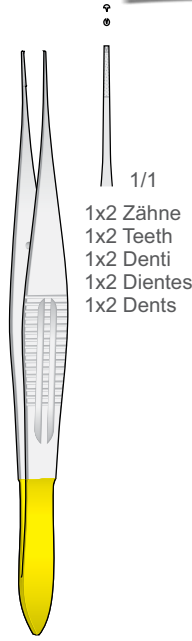


BISHOP-HARMON  
**MF-177** 1,2 mm  
85 mm

Dressing Forceps  
criss-cross serrated tips



BISHOP-HARMON  
**MF-249** 1,2 mm  
85 mm



1/1  
1x2 Zähne  
1x2 Teeth  
1x2 Denti  
1x2 Dientes  
1x2 Dents

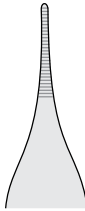
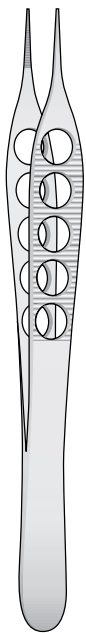
CASTROVIEJO  
**BD-348** 0.9 mm  
120 mm



1/1  
9x9 Zähne  
9x9 Teeth  
9x9 Denti  
9x9 Dientes  
9x9 Dents

BROWN  
**BD-349**  
120 mm

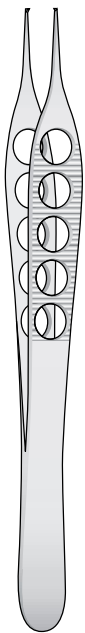
1,2 mm



1/1

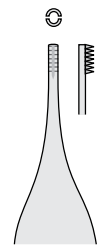
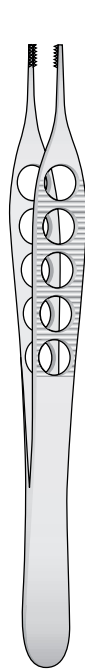
ADSON  
**BD-207**  
120 mm

1,2 mm



1/1

ADSON  
**BD-208**  
120 mm

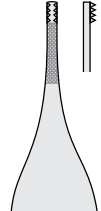
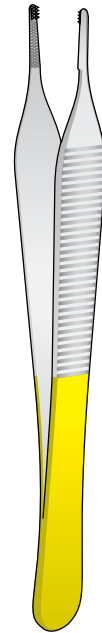


1/1

7x7 Zähne  
7x7 Teeth  
7x7 Denti  
7x7 Dientes  
7x7 Dents

ADSON-BROWN  
**BD-209**  
120 mm

TC

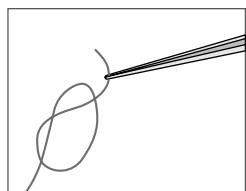


1/1

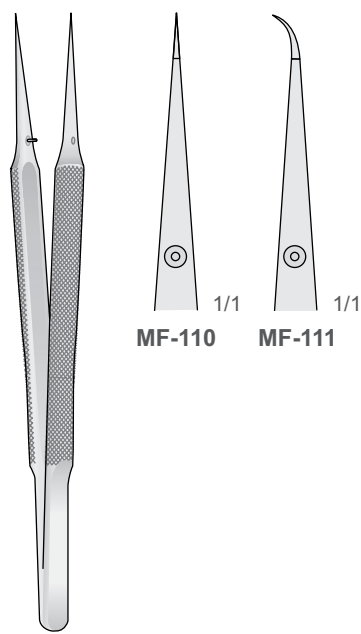
ADSON-BROWN  
**BD-253**  
120 mm



Mikro Pinzetten  
 Delicate Forceps  
 Micro Pinzette  
 Pinzas finas  
 Micro Pincers

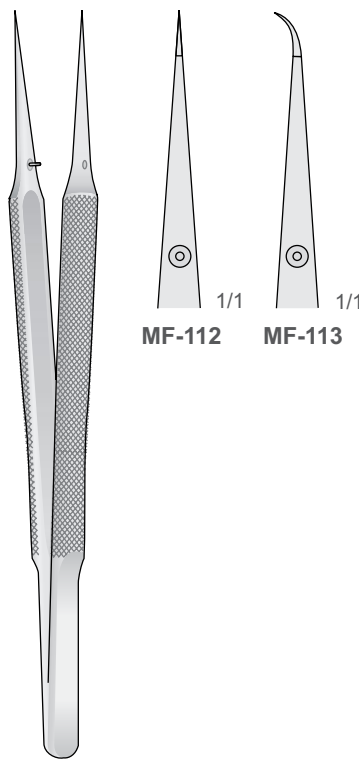


TWEEZERS



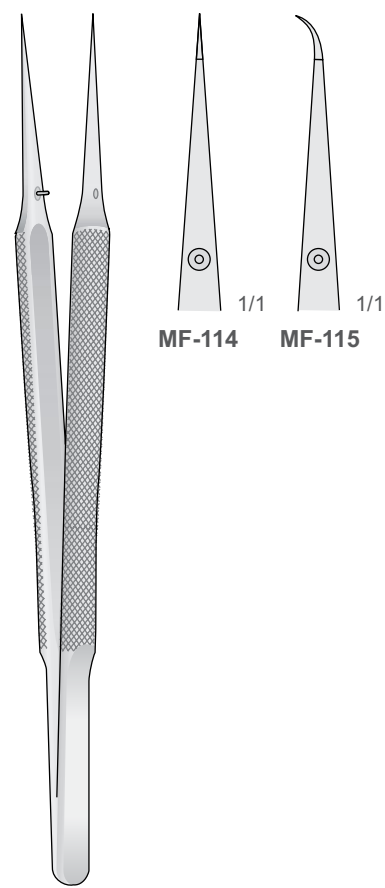
**MF-110** 1/1 **MF-111** 1/1

**MF-110/MF-111**  
120 mm



**MF-112** 1/1 **MF-113** 1/1

**MF-112/MF-113**  
150 mm



**MF-114** 1/1 **MF-115** 1/1

**MF-114/MF-115**  
180 mm



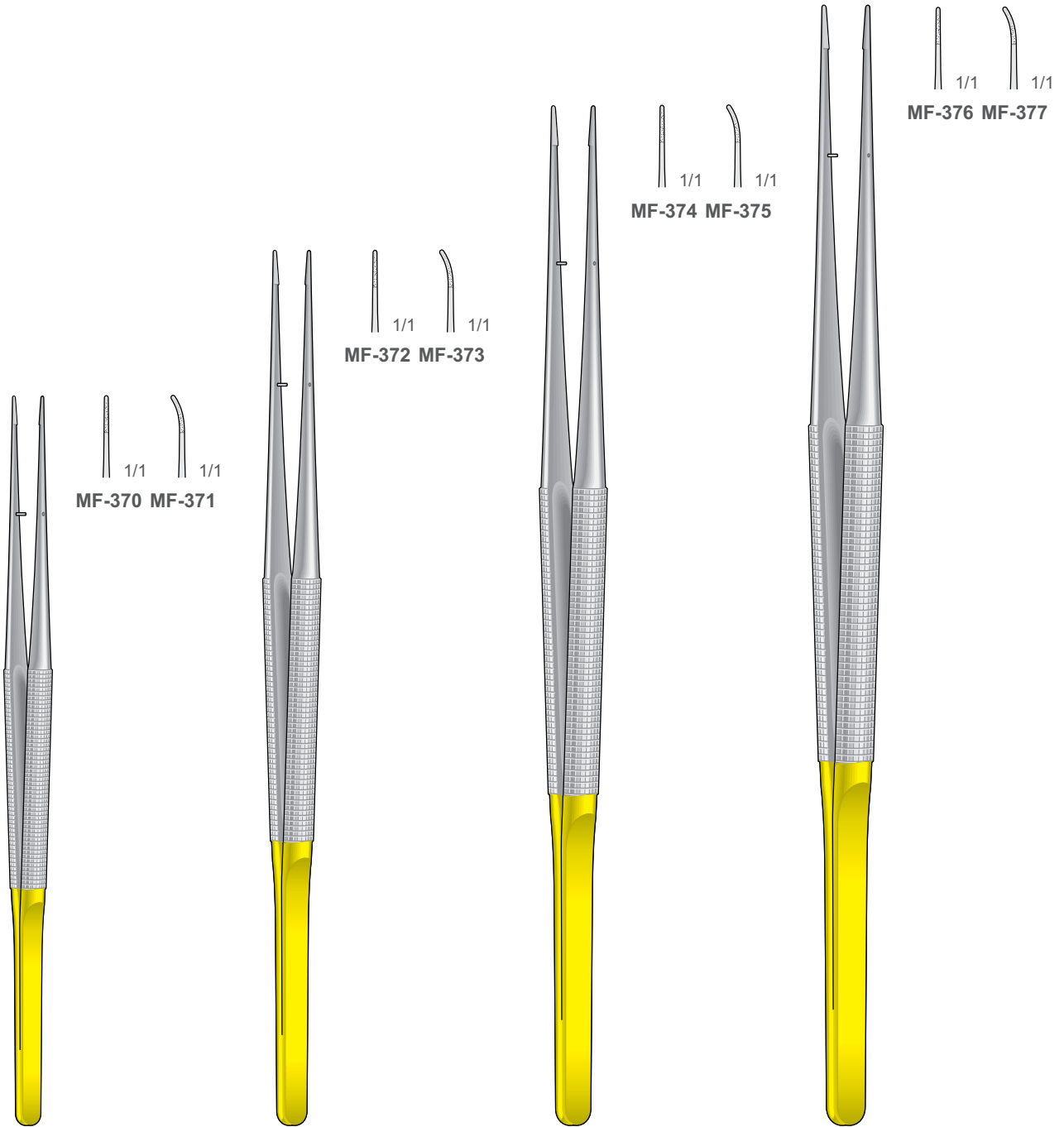
Mikro Pinzette - Rundgriff Ø 8 mm  
Mit Führungsstift diamantiert  
Fadenplatte 6x0,7 mm

Mikro Pinzetten  
Micro Forceps  
Micro Pinzette  
Micro Pinzas  
Micro Pincas



**Diamond Tip**  
Diamantiert  
Punta diamantata  
Punta de diamante  
Pointe de diamant

TWEEZERS



**MF-370/MF-371**  
150 mm

**MF-372/MF-373**  
180 mm

**MF-374/MF-375**  
210 mm

**MF-376/MF-377**  
230 mm



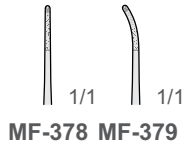
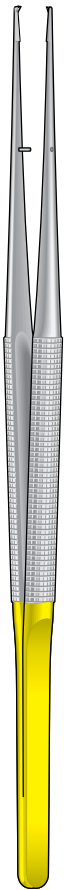
Mikro Pinzetten  
 Micro Forceps  
 Micro Pinzette  
 Micro Pinzas  
 Micro Pincas

Mikro Pinzette - Rundgriff Ø 8 mm  
 Mit Führungsstift diamantiert  
 Fadenplatte 6x0,7 mm



**Diamond Tip**  
 Diamantiert  
 Punta diamantata  
 Punta de diamante  
 Pointe de diamant

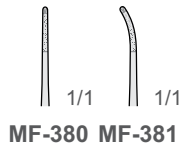
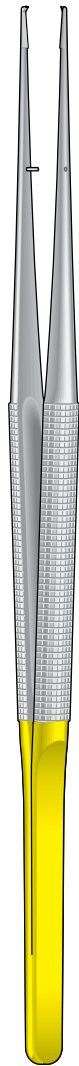
1x2 Zähne  
 1x2 Teeths  
 1x2 Denti  
 1x2 Dientes  
 1x2 Dents



**MF-378 MF-379**

**MF-378/MF-379**  
 150 mm

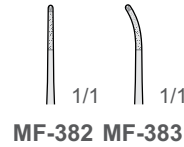
1x2 Zähne  
 1x2 Teeths  
 1x2 Denti  
 1x2 Dientes  
 1x2 Dents



**MF-380 MF-381**

**MF-380/MF-381**  
 180 mm

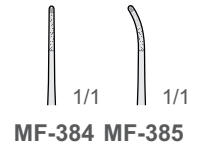
1x2 Zähne  
 1x2 Teeths  
 1x2 Denti  
 1x2 Dientes  
 1x2 Dents



**MF-382 MF-383**

**MF-382/MF-383**  
 210 mm

1x2 Zähne  
 1x2 Teeths  
 1x2 Denti  
 1x2 Dientes  
 1x2 Dents



**MF-384 MF-385**

**MF-384/MF-385**  
 230 mm

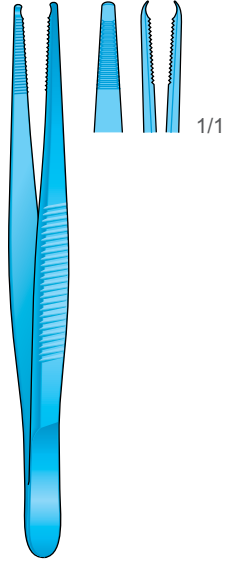
**TWEEZERS**



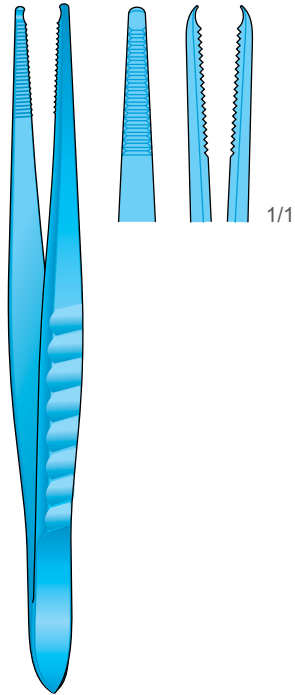
Titan-Pinzetten  
Titanium Tissue Forceps  
Pinzette in titanio  
Pinzas de titanio  
Pincas en titane



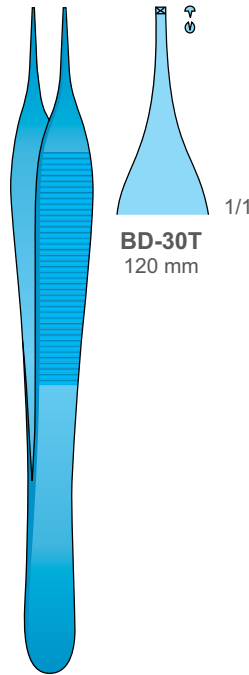
TWEEZERS



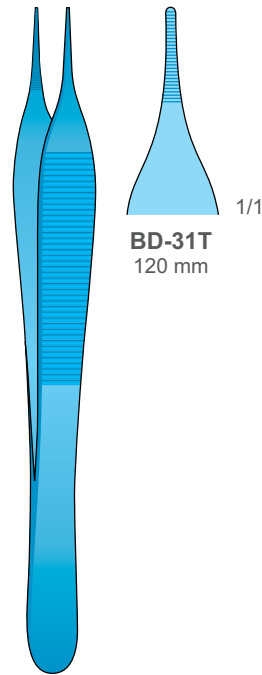
**BD-285T**  
90 mm



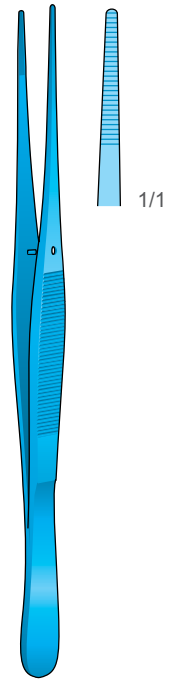
**BD-270T**  
130 mm



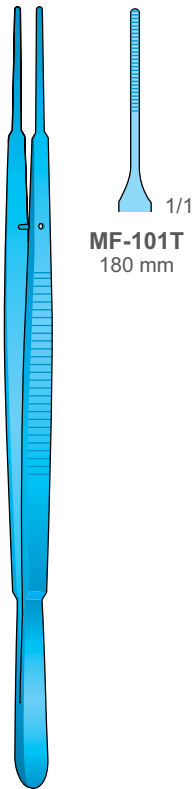
ADSON  
**BD-30T**  
120 mm



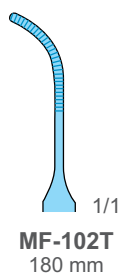
ADSON  
**BD-31T**  
120 mm



**BD-09T**  
130 mm

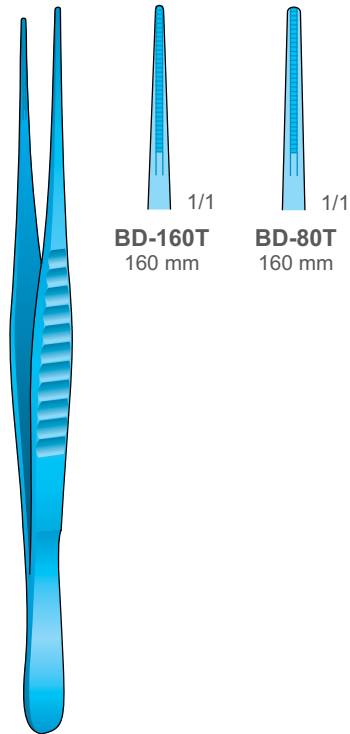


GERALD  
**MF-101T/MF-102T**  
180 mm



**MF-101T**  
180 mm

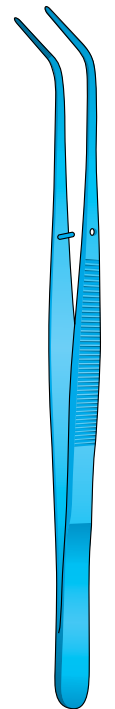
**MF-102T**  
180 mm



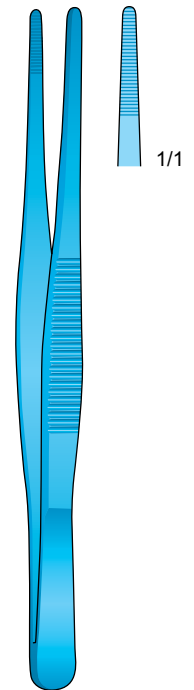
DE BAKEY  
**BD-80T/BD-160T**

**BD-160T**  
160 mm

**BD-80T**  
160 mm



COLLEGE  
**TT-01**  
150 mm



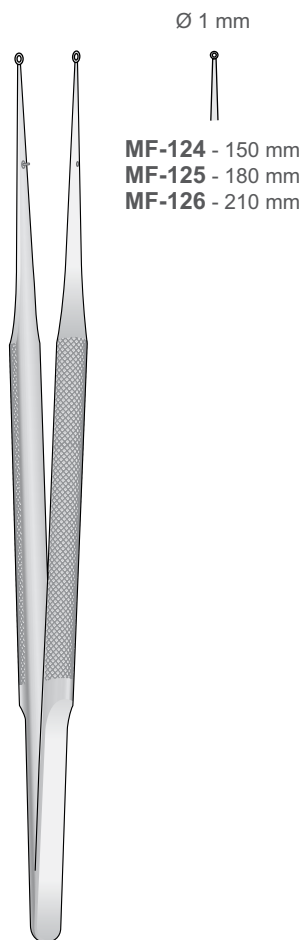
**BD-75T**  
145 mm



Mikro Pinzetten  
 Delicate Forceps  
 Micro Pinzette  
 Pinzas finas  
 Micro Pincers

Rund-Griffe Ø 8 mm  
 Round handle Ø 8 mm  
 Manico rotondo Ø 8 mm  
 Mango redondo Ø 8 mm  
 Manche rond Ø 8 mm

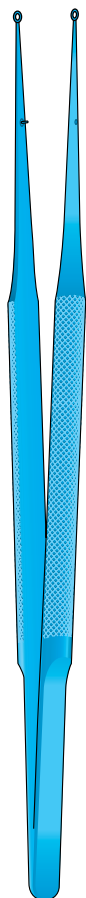
TWEEZERS



**MF-124** - 150 mm  
**MF-125** - 180 mm  
**MF-126** - 210 mm

Ø 2 mm  
**MF-127** - 150 mm  
**MF-128** - 180 mm  
**MF-129** - 210 mm

Titan  
 Titanium  
 Titanio  
 Titano  
 Titane



Ø 1 mm  
**MF-142T** - 150 mm  
**MF-143T** - 180 mm  
**MF-144T** - 210 mm

Ø 2 mm  
**MF-145T** - 150 mm  
**MF-146T** - 180 mm  
**MF-147T** - 210 mm

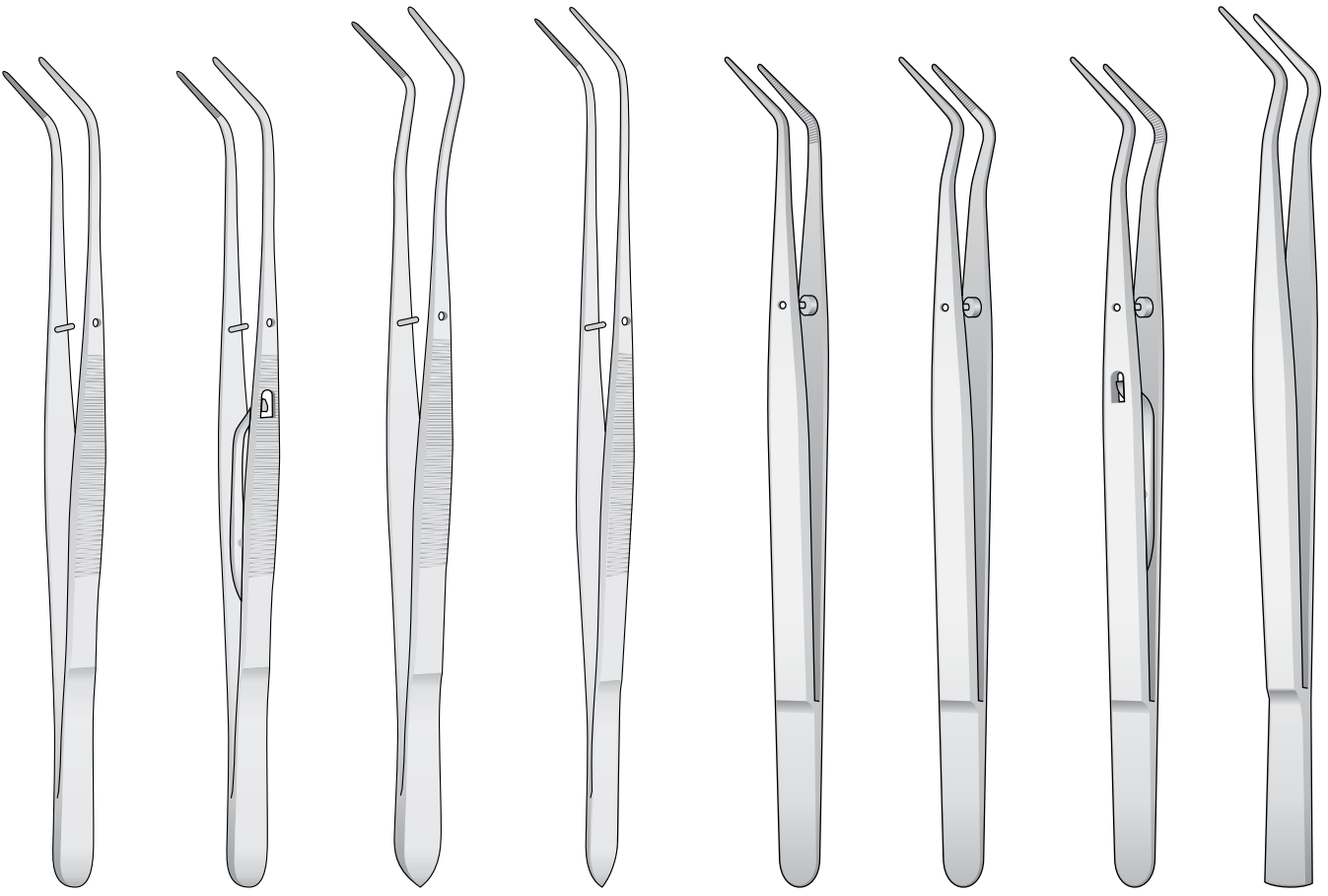
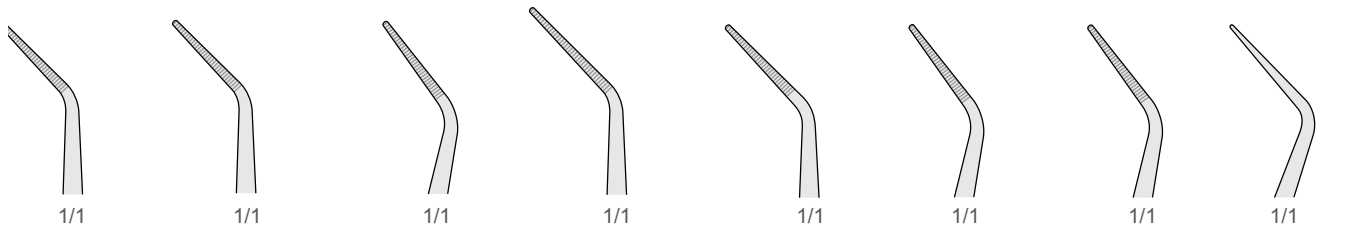


MF-124/MF-129

MF-142T/MF-147T



TWEEZERS



**COLLEGE**  
150 mm

**COLLEGE-S**  
Locking  
150 mm

**MERIAM**  
160 mm

**FLAGG**  
160 mm

**COLLEGE  
BD-01**  
Fig.17  
160 mm

**MERIAM  
BD-02**  
Fig.18  
150 mm

**COLLEGE  
BD-03**  
Fig.18L / Locking  
150 mm

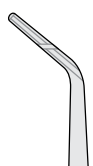
**CAULK  
BD-11**  
160 mm



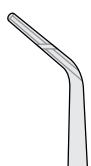


Pinzette für Endodontie  
Endodontic Forceps  
Pinzette per endodonzia  
Pinzas para endodoncia  
Pincas pour endodontie

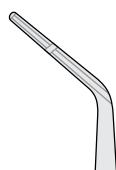
Endo Forceps



1/1



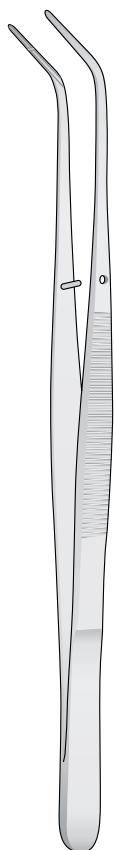
1/1



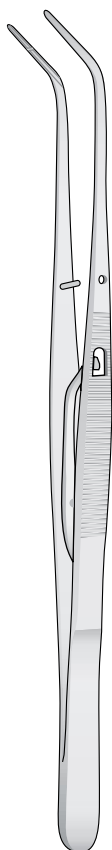
1/1



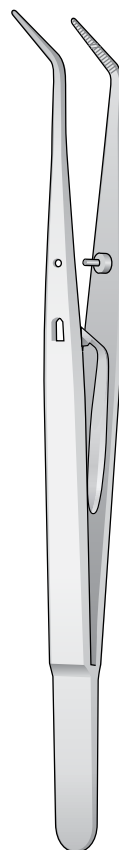
1/1



**DA-04**  
Endo  
150 mm



**DA-05**  
Endo / Locking  
150 mm



**DA-09**  
Endo / Locking  
150 mm



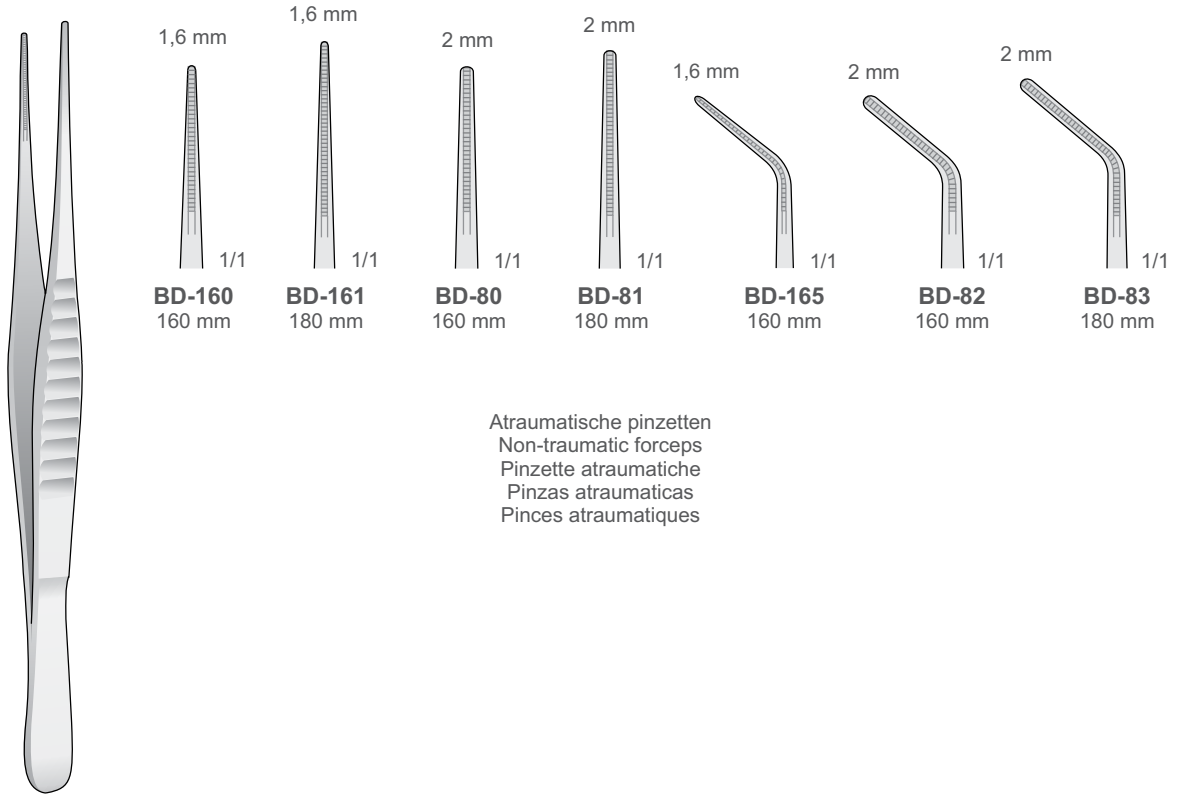
**DA-11**  
Endo / Locking  
155 mm

TWEEZERS



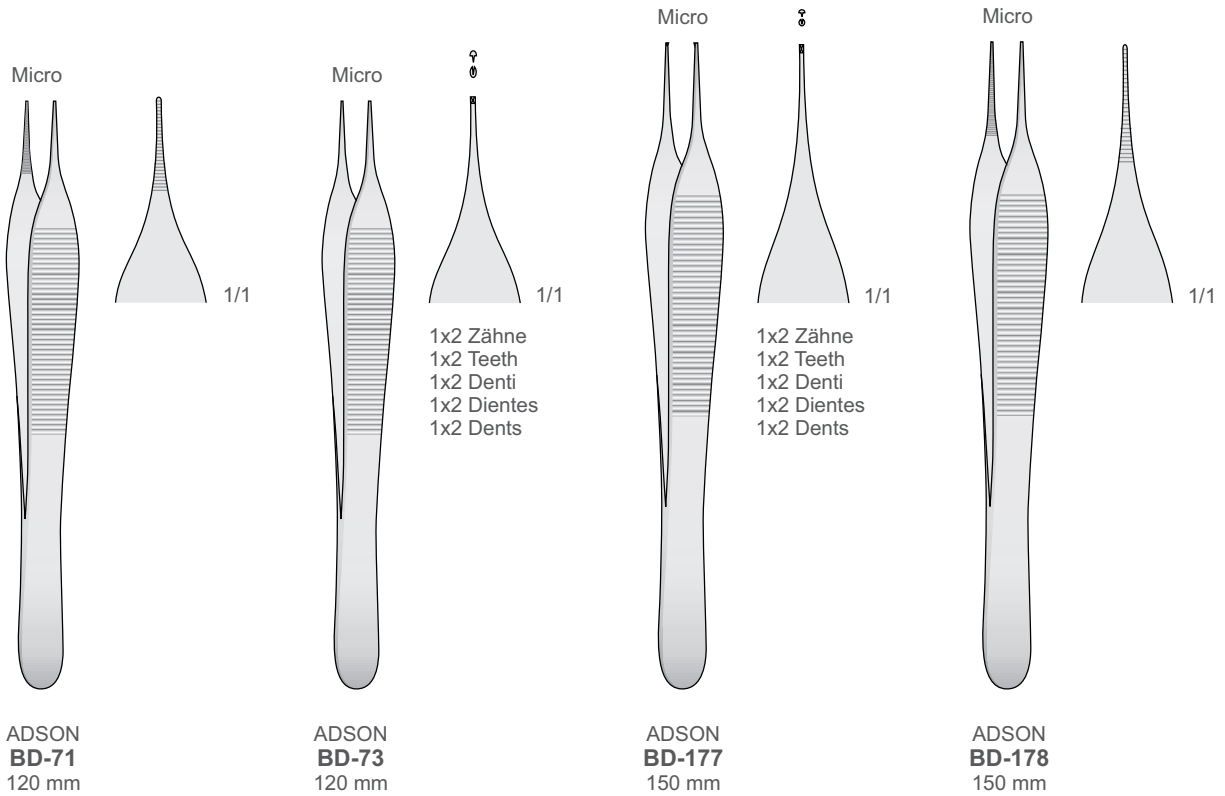
Chirurgische und Anatomische Pinzetten  
 Tissue and Dressing Forceps  
 Pinzette anatomiche e chirurgiche  
 Pinzas de diseccion y chirurgicalas  
 Pincas anatomiques chirurgicales

TWEEZERS



Atraumatische pinzetten  
 Non-traumatic forceps  
 Pinzette atraumatiche  
 Pinzas atraumaticas  
 Pincas atraumatiques

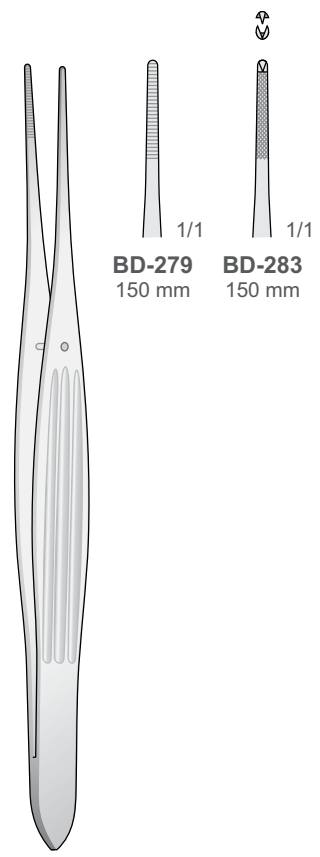
DE BAKEY  
 BD-80/BD-165



Chirurgische Pinzetten  
 Tissue Forceps  
 Pinzette chirurgiche  
 Pinzas quirùrgicas  
 Pincas quirurgicales

TWEEZERS

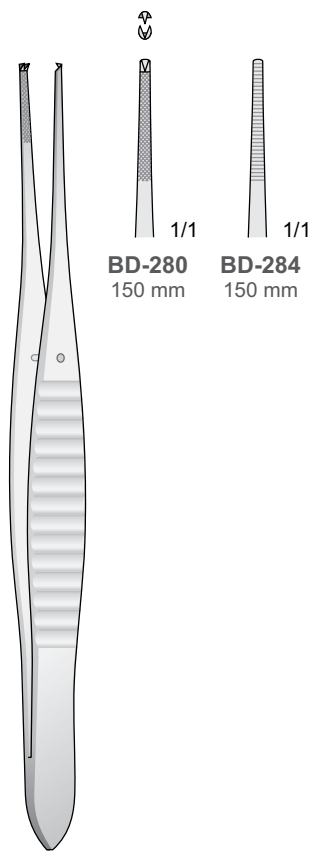
Taschenmarkierungspinzetten  
 Pocket markers  
 Pinzette segnatasche  
 Pinzas para marcar el sulco periodontal  
 Pincas à marker la poche



**BD-279**  
150 mm

**BD-283**  
150 mm

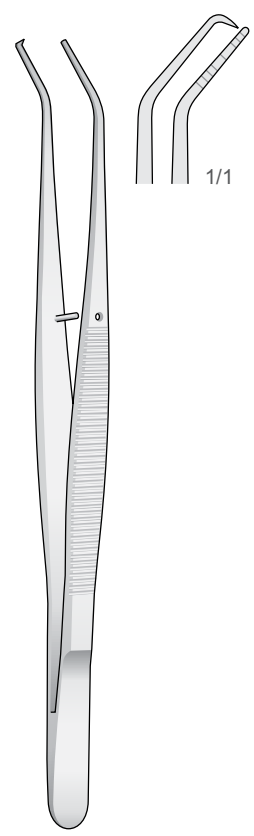
McINDOE  
**BD-279/BD-283**  
 150 mm



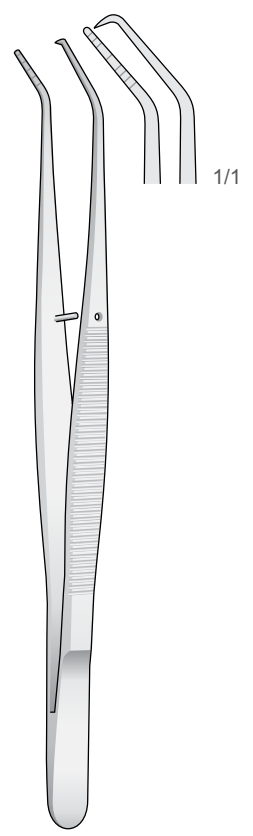
**BD-280**  
150 mm

**BD-284**  
150 mm

GILLIES  
**BD-280/BD-284**  
 150 mm



CRANE-CAPLAN  
**DB-01**  
 150 mm

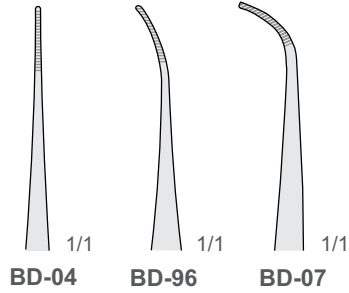


CRANE-CAPLAN  
**DB-02**  
 150 mm

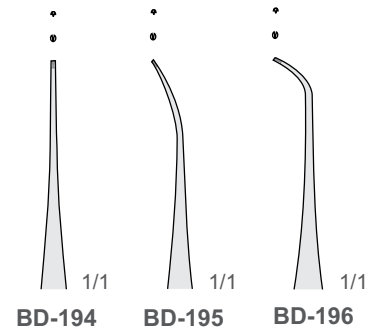




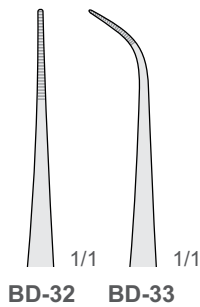
GRAEFE  
 BD-04/BD-96  
 100 mm



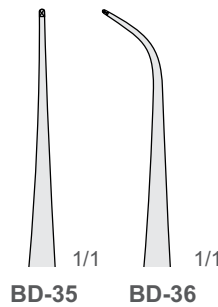
GRAEFE  
 BD-194/BD-196  
 100 mm



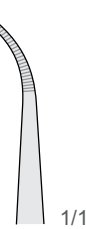
BD-32/BD-33  
 100 mm



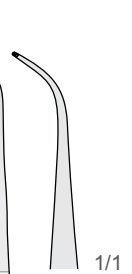
BD-35/BD-36  
 100 mm



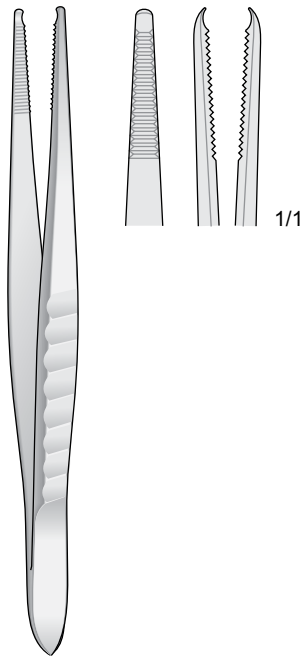
PERRY  
 BD-05  
 125 mm



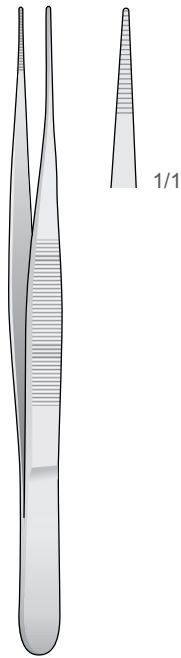
BD-06  
 125 mm



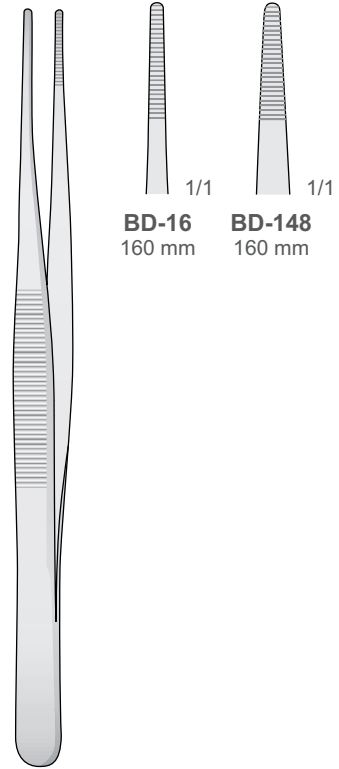
Anatomische Pinzetten  
 Dressing Forceps  
 Pinzette anatomiche  
 Pinzas de diseccion  
 Pinces anatomiques



**BD-270**  
130 mm

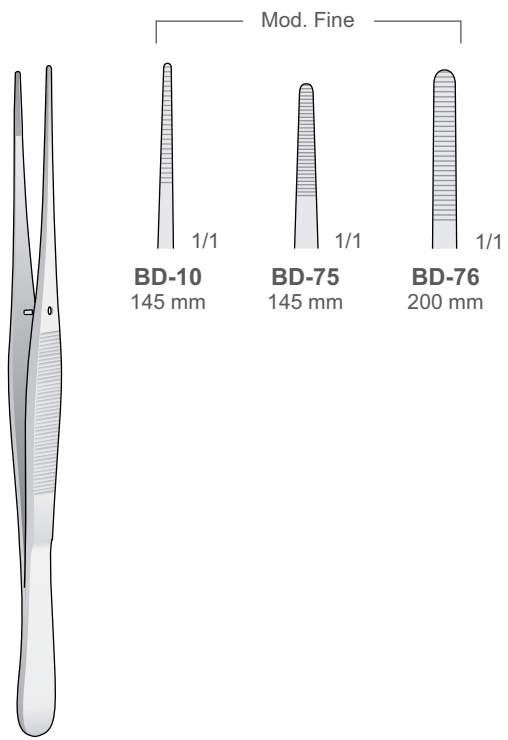


**BD-145**  
130 mm



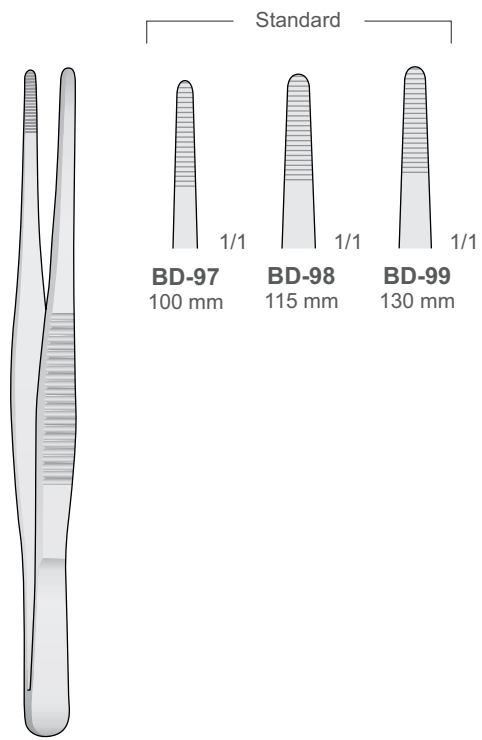
**BD-16** 160 mm  
**BD-148** 160 mm

TWEEZERS



**BD-10** 145 mm  
**BD-75** 145 mm  
**BD-76** 200 mm

**BD-10/BD-76**



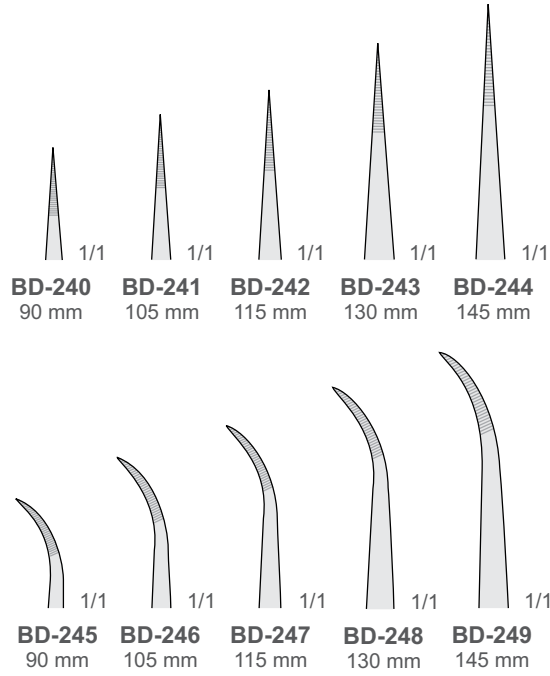
**BD-97** 100 mm  
**BD-98** 115 mm  
**BD-99** 130 mm

**BD-97/BD-99**

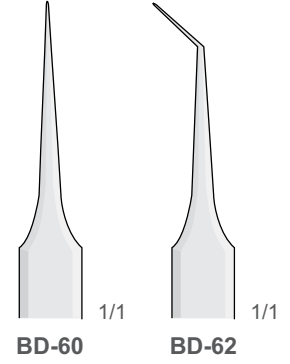


Chirurgische Pinzetten  
Tissue Forceps  
Pinzette chirurgiche  
Pinzas chirùrgicas  
Pinces chirurgicales

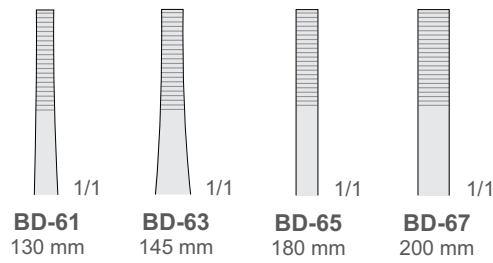
TWEEZERS



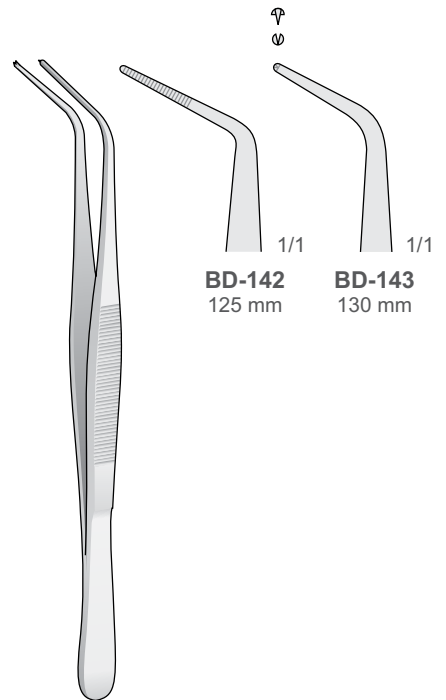
**BD-240/BD-249**



**BD-60/BD-62**  
110 mm



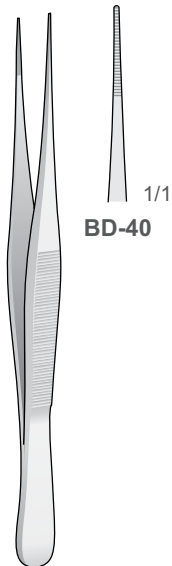
**STILLE**  
**BD-61/BD-67**



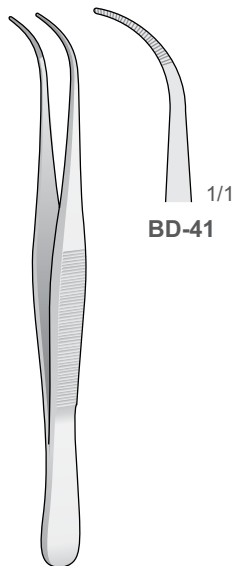
**BD-142/BD-143**



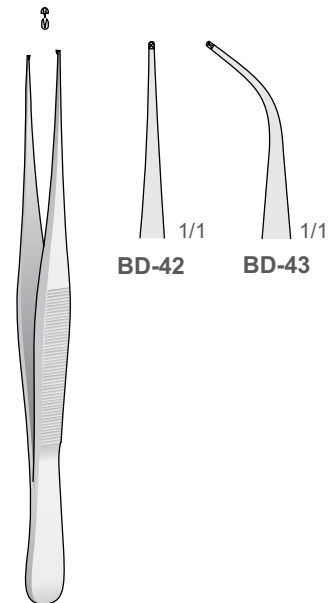
Chirurgische Pinzetten  
 Tissue Forceps  
 Pinzette chirurgische  
 Pinzas quirúrgicas  
 Pincas quirurgicales



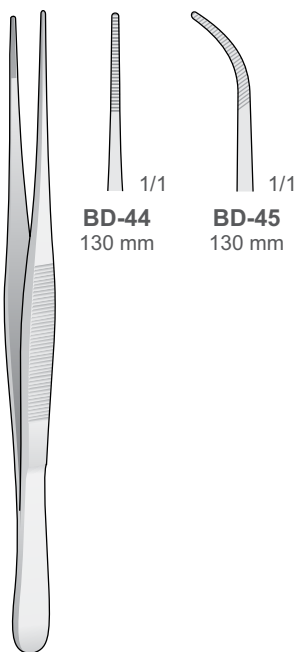
**BD-40**  
110 mm



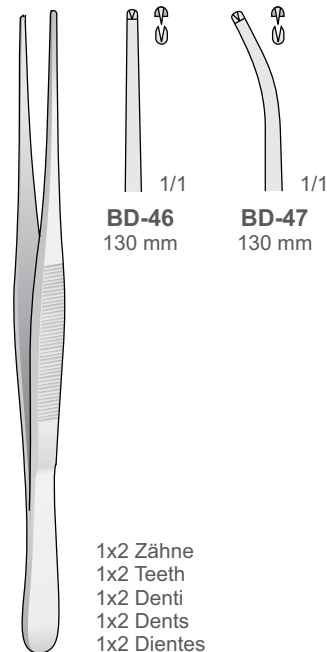
**BD-41**  
110 mm



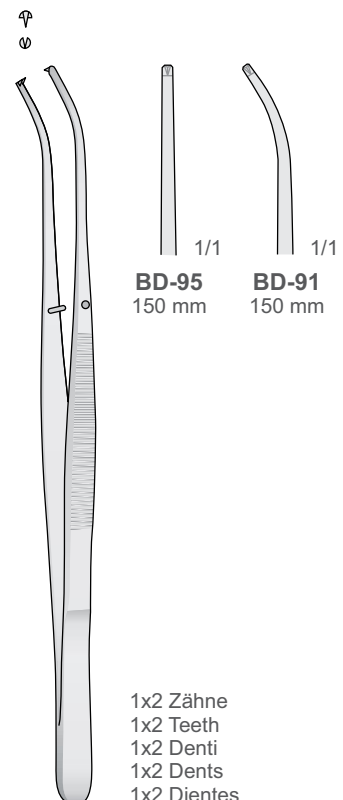
**BD-42/BD-43**  
110 mm



SEMKEN  
**BD-44/BD-45**  
130 mm



SEMKEN  
**BD-46/BD-47**  
130 mm



SEMKEN  
**BD-91/BD-95**  
150 mm

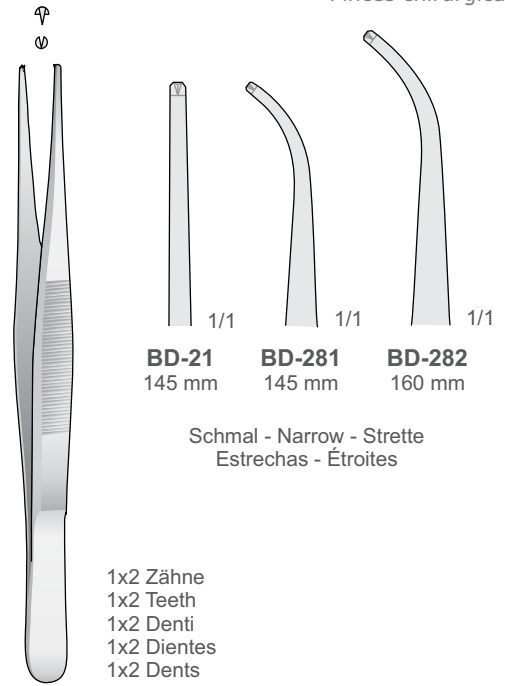
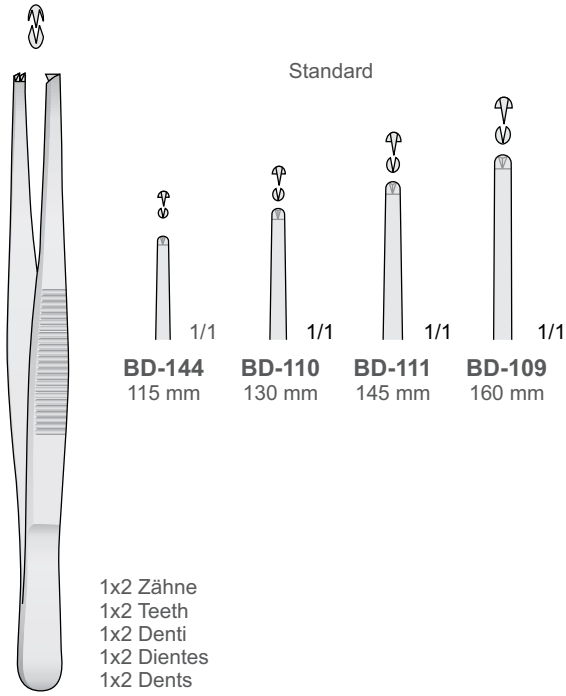
1x2 Zähne  
1x2 Teeth  
1x2 Denti  
1x2 Dents  
1x2 Dientes

1x2 Zähne  
1x2 Teeth  
1x2 Denti  
1x2 Dents  
1x2 Dientes

TWEEZERS

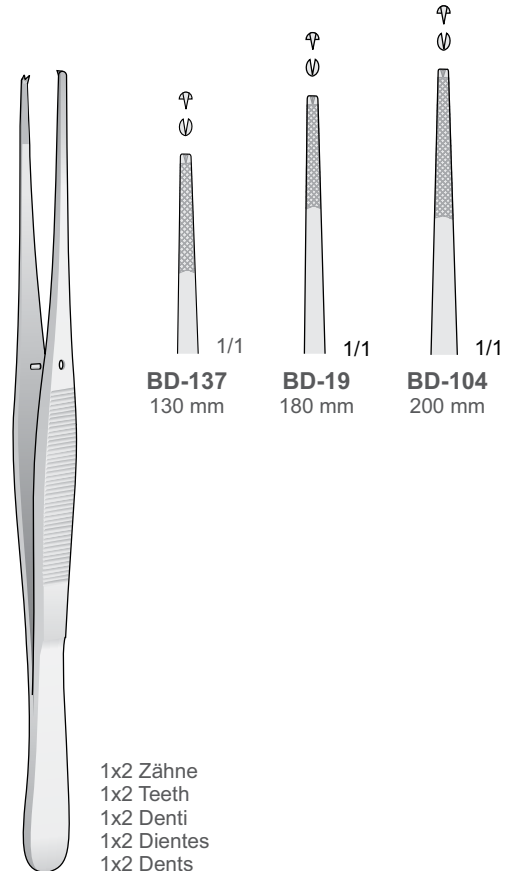
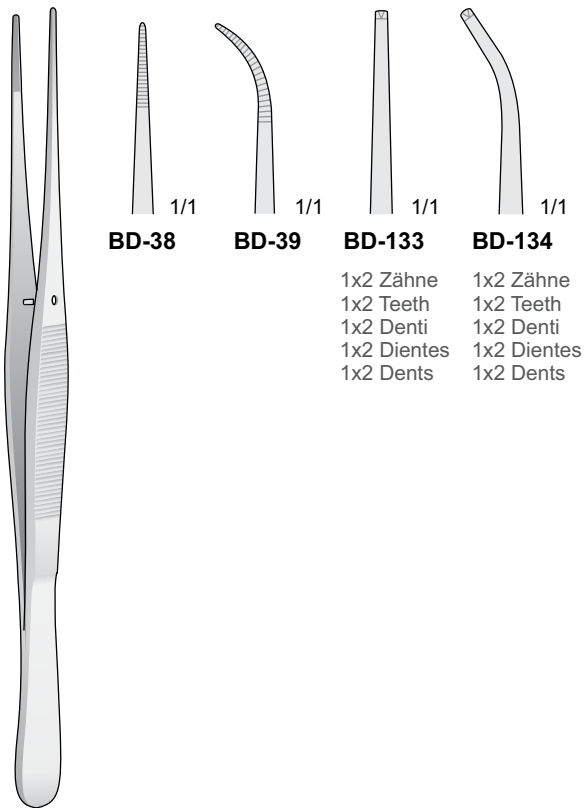


Chirurgische Pinzetten  
Tissue Forceps  
Pinzette chirurgiche  
Pinzas chirùrgicas  
Pincas chirurgicales



**BD-109/BD-144**

**BD-21/BD-282**



**BD-38/BD-134**  
200 mm

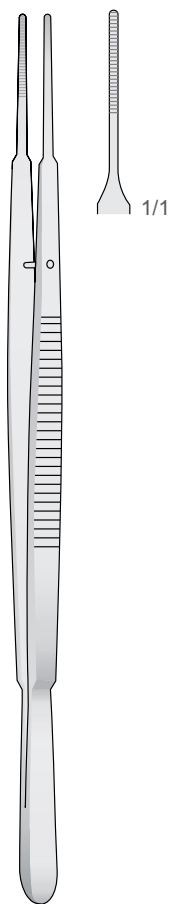
**BD-19/BD-137**



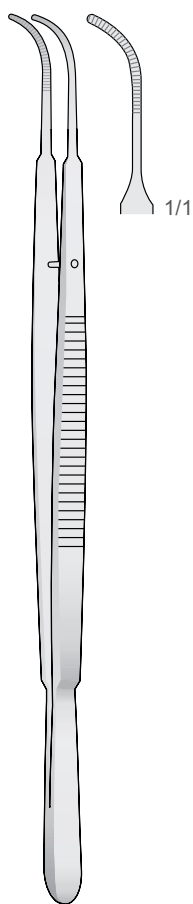


Chirurgische Pinzetten  
Tissue Forceps  
Pinzette chirurgiche  
Pinzas quirùrgicas  
Pincas quirurgicales

TWEEZERS



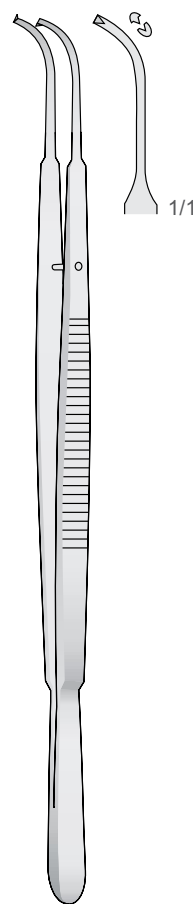
GERALD  
MF-101  
180 mm



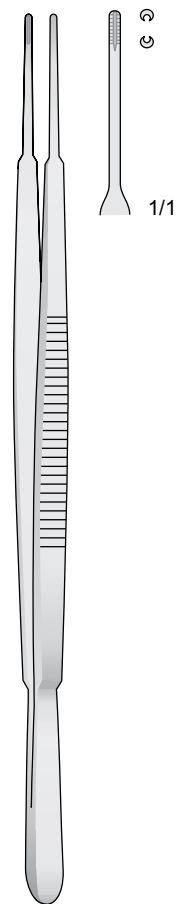
GERALD  
MF-102  
180 mm



GERALD  
MF-103  
180 mm



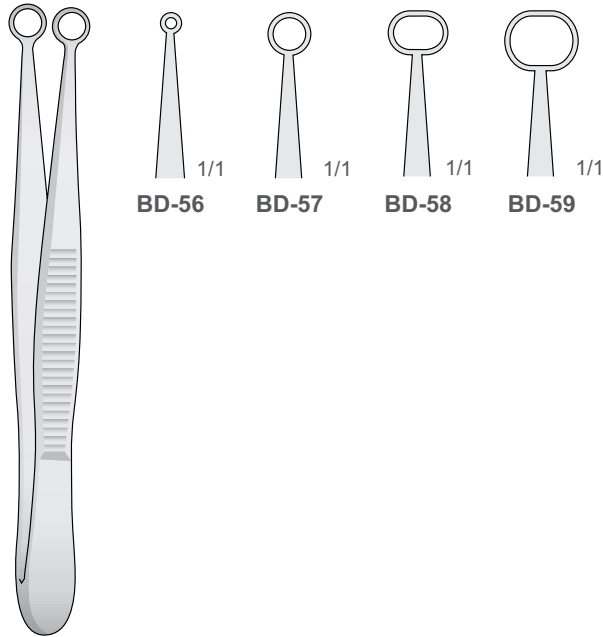
GERALD  
MF-104  
180 mm



GERALD-BROWN  
MF-105  
180 mm



Membrane Forceps  
with delicate Ring tip



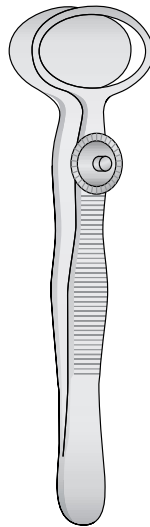
BD-56

BD-57

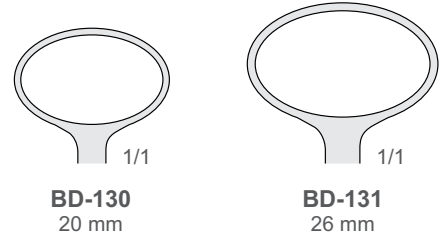
BD-58

BD-59

BD-56/BD-59  
100 mm

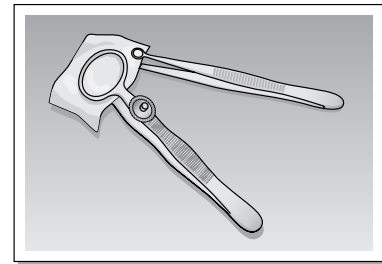


DESMARRES  
BD-130/BD-131  
90 mm

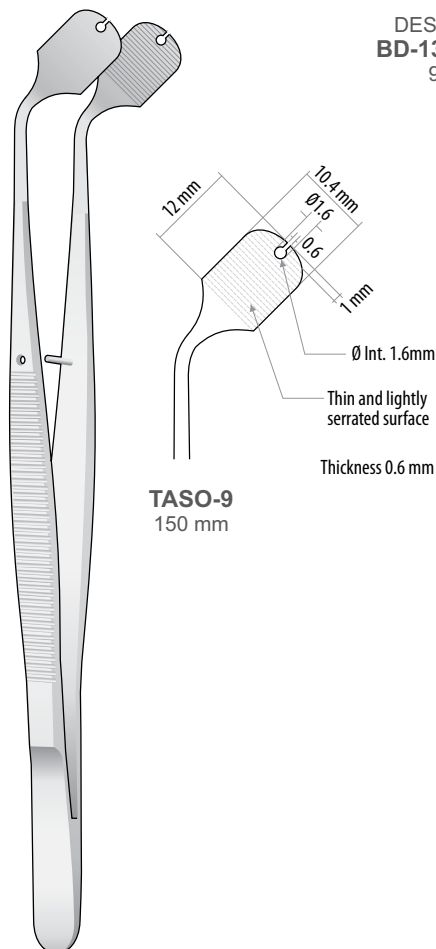


BD-130  
20 mm

BD-131  
26 mm



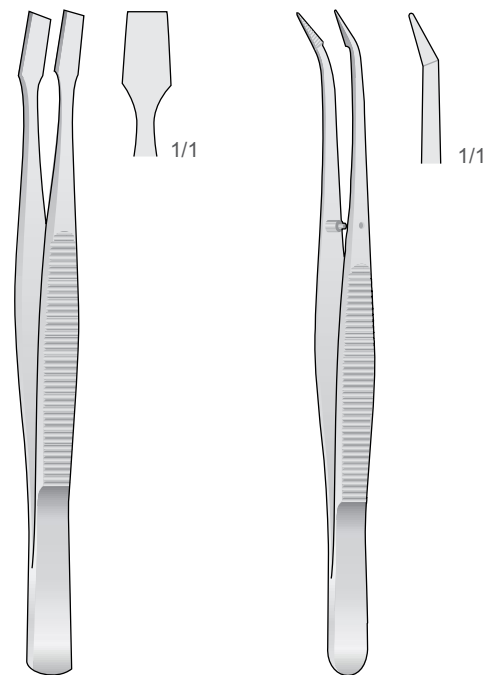
TWEEZERS



TASO-9  
150 mm

12 mm  
10.4 mm  
Ø 1.6  
0.6  
1 mm  
Ø Int. 1.6 mm  
Thin and lightly serrated surface  
Thickness 0.6 mm

Pinzetten zum Halten Membranen  
Membrane Holding forceps  
Pinza per fissaggio membrane  
Pinza para sostener membranas  
Pince pour le maintien membranes

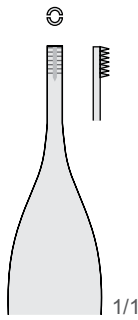
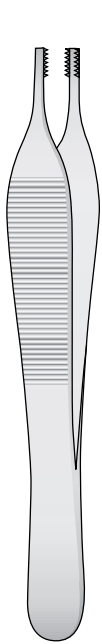


KÜHNE  
ES-44  
105 mm

BARRAQUER  
ES-65  
105 mm

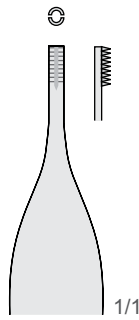


Chirurgische Pinzetten  
 Tissue Forceps  
 Pinzette chirurgische  
 Pinzas quirúrgicas  
 Pincas quirúrgicas



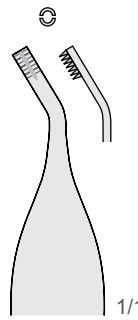
**BD-92**  
120 mm

6x6 Zähne  
 6x6 Teeth  
 6x6 Denti  
 6x6 Dientes  
 6x6 Dents



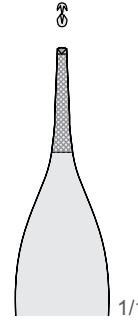
**BD-141**  
120 mm

9x9 Zähne  
 9x9 Teeth  
 9x9 Denti  
 9x9 Dientes  
 9x9 Dents



**BD-93**  
120 mm

6x6 Zähne  
 6x6 Teeth  
 6x6 Denti  
 6x6 Dientes  
 6x6 Dents

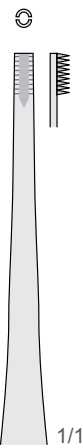


**BD-90**  
120 mm

ADSON  
**BD-90**  
120 mm

ADSON-BROWN  
**BD-92/BD-141**  
120 mm

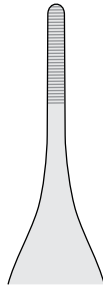
TWEEZERS



8x8 Zähne  
 8x8 Teeth  
 8x8 Denti  
 8x8 Dientes  
 8x8 Dents

BROWN  
**BD-94**  
150 mm

Standard



1/1

ADSON  
**BD-380**  
150 mm

Standard



1/1

1x2 Zähne  
 1x2 Teeth  
 1x2 Denti  
 1x2 Dientes  
 1x2 Dents

ADSON  
**BD-381**  
150 mm

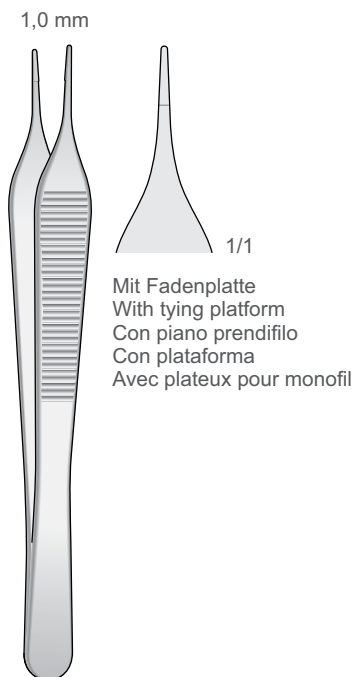


1/1

9x9 Zähne  
 9x9 Teeth  
 9x9 Denti  
 9x9 Dientes  
 9x9 Dents

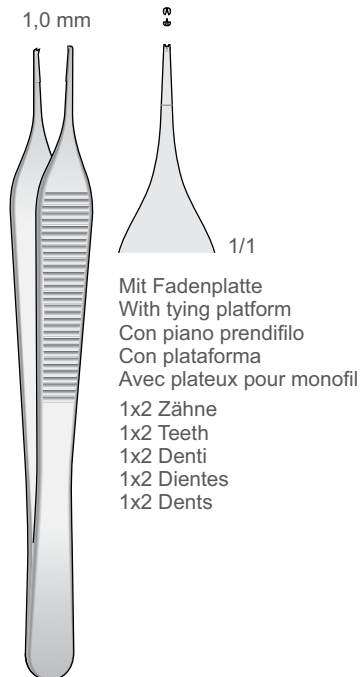
ADSON-BROWN  
**BD-382**  
150 mm





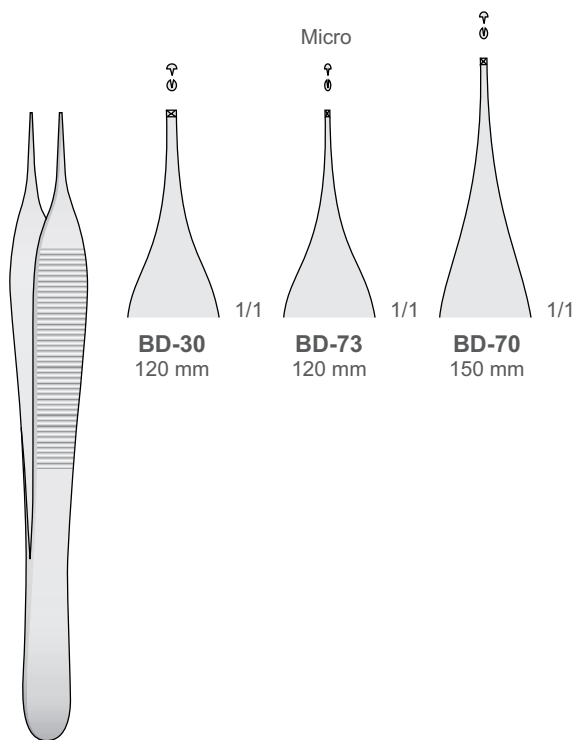
Mit Fadenplatte  
With tying platform  
Con piano prendifilo  
Con plataforma  
Avec plateaux pour monofil

ADSON  
**BD-370**  
120 mm

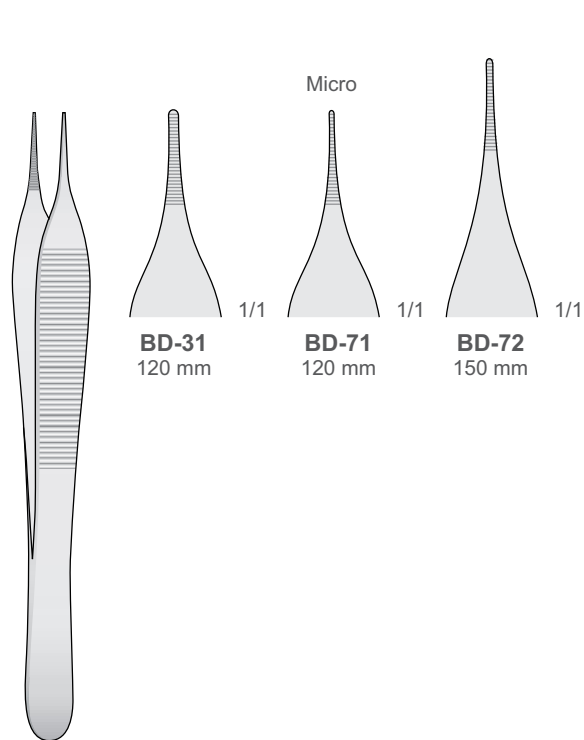


Mit Fadenplatte  
With tying platform  
Con piano prendifilo  
Con plataforma  
Avec plateaux pour monofil  
1x2 Zähne  
1x2 Teeth  
1x2 Denti  
1x2 Dientes  
1x2 Dents

ADSON  
**BD-371**  
120 mm

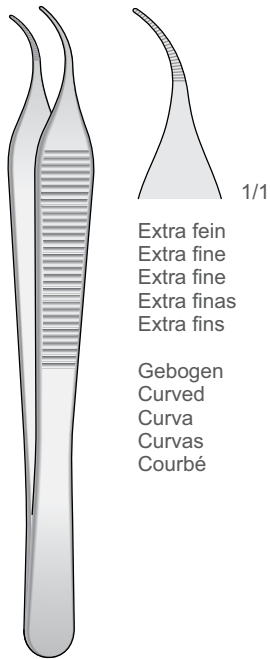


ADSON  
**BD-30/BD-73**



ADSON  
**BD-31/BD-72**

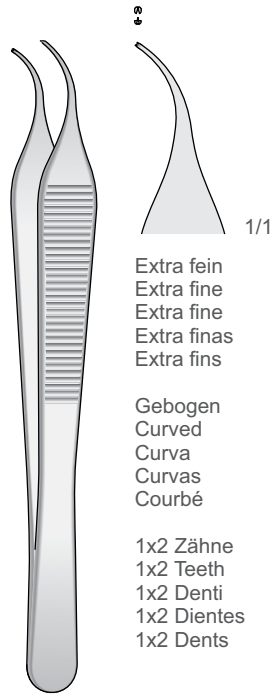
Chirurgische Pinzetten - Anatomische Pinzetten  
 Tissue Forceps - Dressing forceps  
 Pinzette chirurgiche - Pinzette anatomiche  
 Pinzas quirùrgicas - Pinzas de diseccion  
 Pincas quirurgicales - Pincas anatomiques



Extra fein  
 Extra fine  
 Extra fine  
 Extra finas  
 Extra fins

Gebogen  
 Curved  
 Curva  
 Curvas  
 Courbé

**MICRO-ADSON  
 BD-372**  
 120 mm

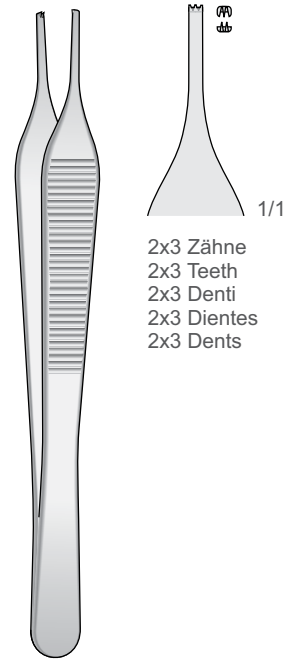


Extra fein  
 Extra fine  
 Extra fine  
 Extra finas  
 Extra fins

Gebogen  
 Curved  
 Curva  
 Curvas  
 Courbé

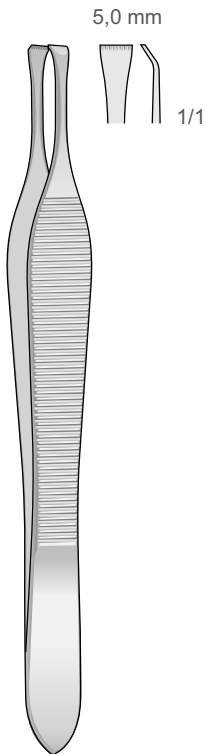
1x2 Zähne  
 1x2 Teeth  
 1x2 Denti  
 1x2 Dientes  
 1x2 Dents

**MICRO-ADSON  
 BD-373**  
 120 mm

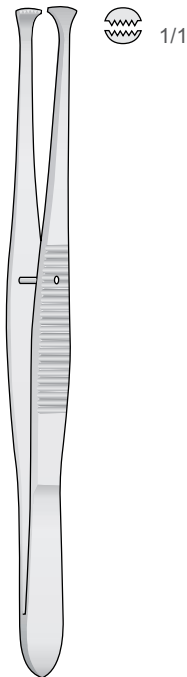


2x3 Zähne  
 2x3 Teeth  
 2x3 Denti  
 2x3 Dientes  
 2x3 Dents

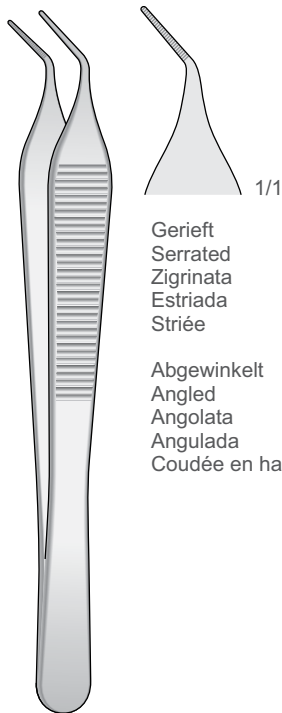
**ADSON  
 BD-377**  
 120 mm



**BEASLEY-BABCOCK  
 BD-51**  
 120 mm



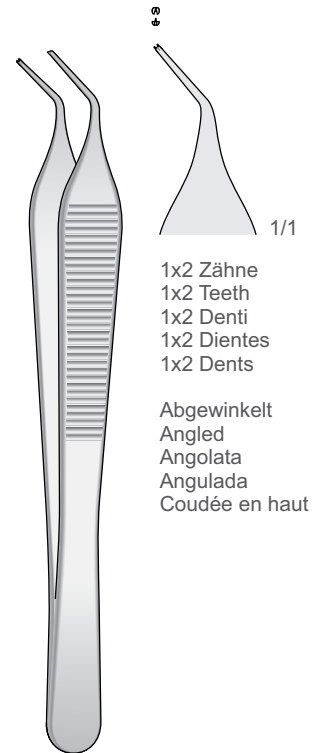
**GRAEFE  
 BD-135**  
 110 mm



Gerieft  
 Serrated  
 Zigrinata  
 Estriada  
 Striée

Abgewinkelt  
 Angled  
 Angolata  
 Angulada  
 Coudée en haut

**ADSON  
 BD-378**  
 120 mm



1x2 Zähne  
 1x2 Teeth  
 1x2 Denti  
 1x2 Dientes  
 1x2 Dents

Abgewinkelt  
 Angled  
 Angolata  
 Angulada  
 Coudée en haut

**ADSON  
 BD-379**  
 120 mm

**TWEEZERS**

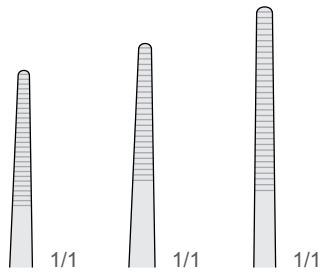


Chirurgische Pinzetten - Anatomische Pinzetten  
 Tissue Forceps - Dressing forceps  
 Pinzette chirurgiche - Pinzette anatomiche  
 Pinzas quirùrgicas - Pinzas de diseccion  
 Pincas quirurgicales - Pincas anatomiques

TWEZERS



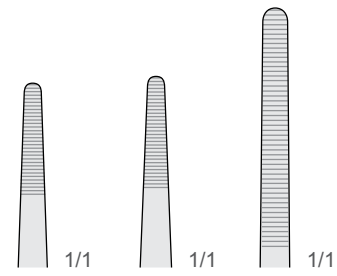
BD-09/BD-20



**BD-09** 130 mm  
**BD-18** 180 mm  
**BD-20** 200 mm



BD-23/BD-26



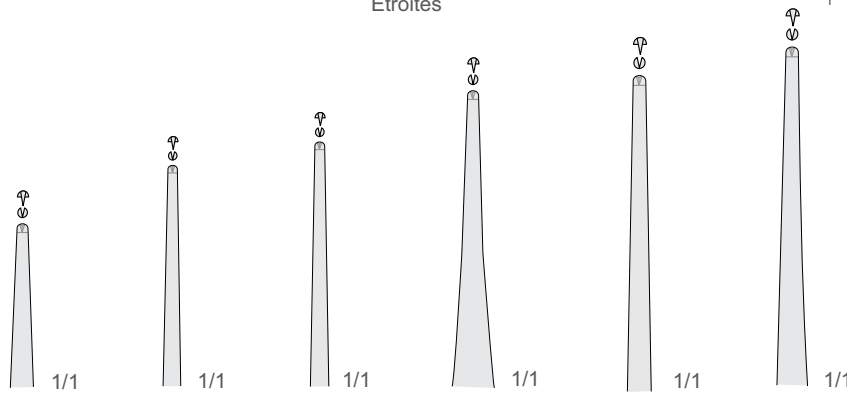
**BD-23** 230 mm  
**BD-25** 250 mm  
**BD-26** 300 mm



BD-271/BD-276

1x2 Zähne  
 1x2 Teeth  
 1x2 Denti  
 1x2 Dientes  
 1x2 Dents

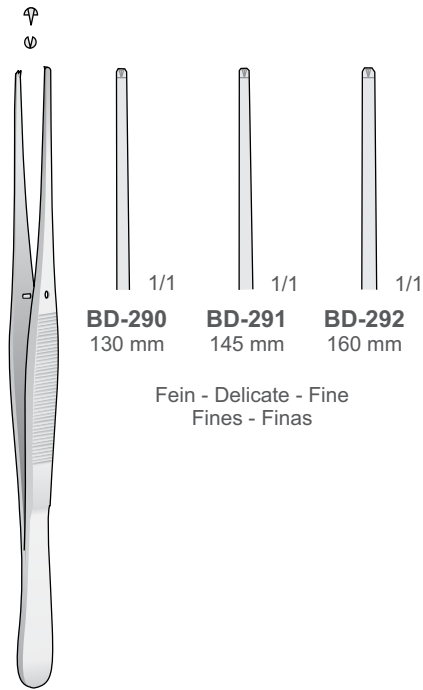
Schmal - Narrow  
 Strette - Estrechas  
 Étroites



**BD-271** 115 mm  
**BD-272** 130 mm  
**BD-273** 145 mm  
**BD-274** 160 mm  
**BD-275** 180 mm  
**BD-276** 200 mm



Chirurgische Pinzetten  
 Tissue Forceps  
 Pinzette chirurgische  
 Pinzas quirúrgicas  
 Pincas quirúrgicas



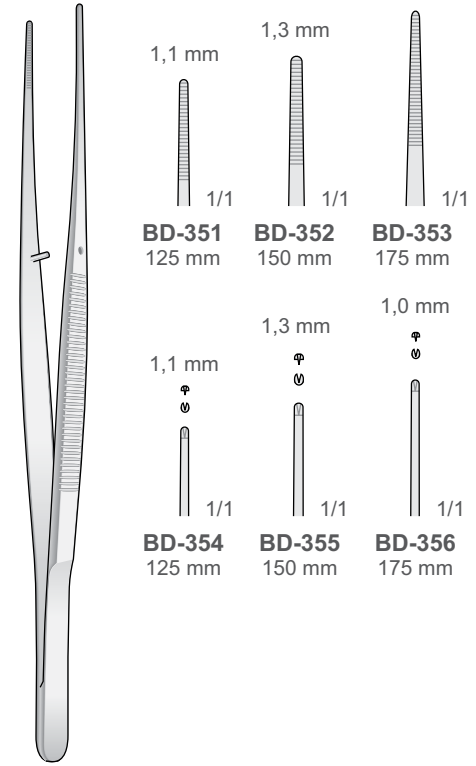
**BD-290/BD-292**

**BD-290**  
130 mm

**BD-291**  
145 mm

**BD-292**  
160 mm

Fein - Delicate - Fine  
 Fines - Finas



**BD-351/BD-356**

1,1 mm

1,3 mm

1,0 mm

**BD-351**  
125 mm

**BD-352**  
150 mm

**BD-353**  
175 mm

1,1 mm

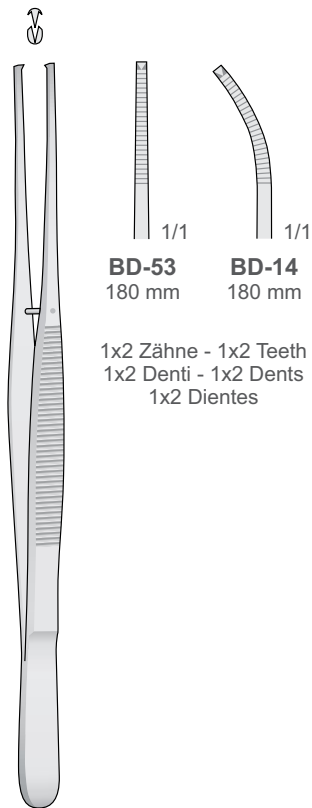
1,3 mm

1,0 mm

**BD-354**  
125 mm

**BD-355**  
150 mm

**BD-356**  
175 mm

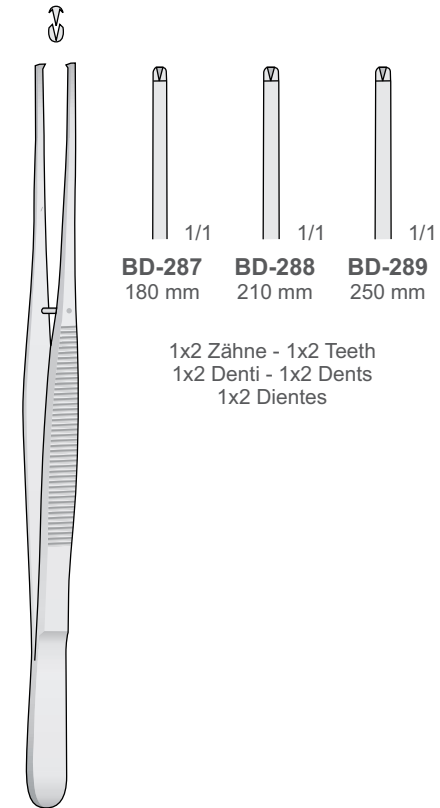


**POTTS-SMITH**  
**BD-14/BD-53**  
 180 mm

**BD-53**  
180 mm

**BD-14**  
180 mm

1x2 Zähne - 1x2 Teeth  
 1x2 Denti - 1x2 Dents  
 1x2 Dientes



**POTTS-SMITH**  
**BD-287/BD-289**

**BD-287**  
180 mm

**BD-288**  
210 mm

**BD-289**  
250 mm

1x2 Zähne - 1x2 Teeth  
 1x2 Denti - 1x2 Dents  
 1x2 Dientes

**TWEEZERS**



Chirurgische Pinzetten, Atraumatische Pinzetten  
 Tissue Forceps, Non-traumatic Forceps  
 Pinzette chirurgische, Pinzette atraumatische  
 Pinzas quirùrgicas, Pinzas atraumáticas  
 Pincas quirurgicales, Pincas atraumatiques

TWEZERS

TC

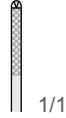


**MF-106**  
175 mm



1/1

**MF-107**  
175 mm



1/1

1x2 Zähne  
 1x2 Teeth  
 1x2 Denti  
 1x2 Dientes  
 1x2 Griffes

GERALD  
**MF-106/MF-107**  
 175 mm



**Tungsten-Carbide Inserts**  
 Mit Hartmetalleinsätzen  
 Plaquettes en carbure de tungstène  
 Plaquetas de carburo de tungsteno  
 Inserti in carburo di tungsteno

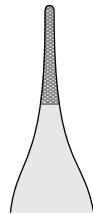
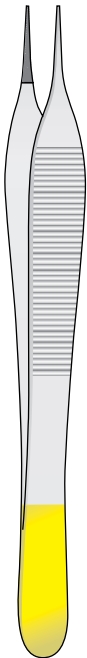
TC



1/1

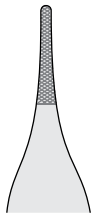
WANGENSTEEN  
**BD-232**  
 150 mm

TC



1/1

**BD-230**  
120 mm

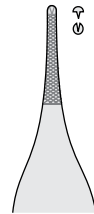
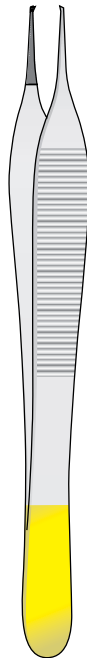


1/1

**BD-231**  
150 mm

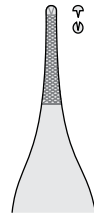
ADSON  
**BD-230/BD-231**

TC



1/1

**BD-250**  
120 mm



1/1

**BD-251**  
150 mm

1x2 Zähne  
 1x2 Teeth  
 1x2 Denti  
 1x2 Dientes  
 1x2 Griffes

1x2 Zähne  
 1x2 Teeth  
 1x2 Denti  
 1x2 Dientes  
 1x2 Griffes

ADSON  
**BD-250/BD-251**



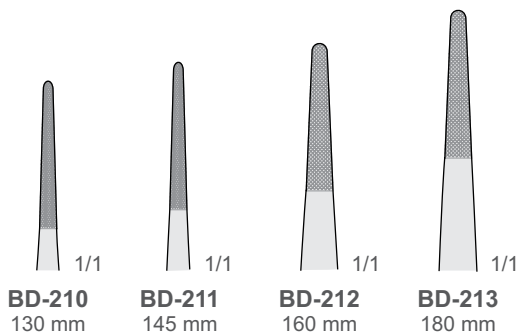


Chirurgische Pinzetten, Atraumatische Pinzetten  
 Tissue Forceps, Non-traumatic Forceps  
 Pinzette chirurgiche, Pinzette atraumatiche  
 Pinzas quirùrgicas, Pinzas atraumáticas  
 Pincas quirùrgicas, Pincas atraumáticas

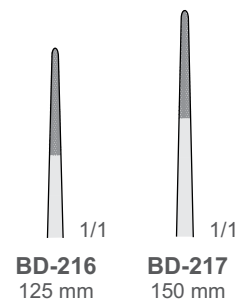


BD-210/BD-213

Standard



SEMKEN  
 BD-216/BD-217

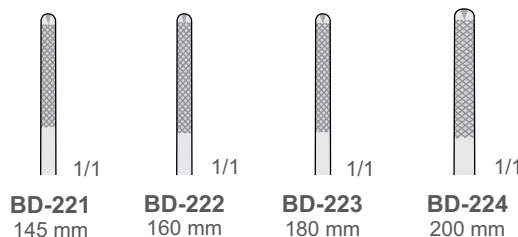


**TC**  
**TUNGSTEN CARBIDE**

**Tungsten-Carbide Inserts**  
 Mit Hartmetalleinsätzen  
 Plaquettes en carbure de tungstène  
 Plaquetas de carburo de tungsteno  
 Inserti in carburo di tungsteno



BD-221/BD-224



DE BAKEY  
 BD-267  
 160 mm

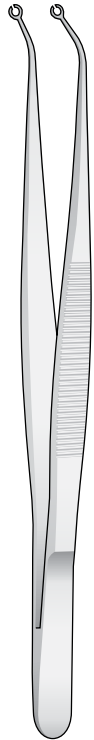


TWEEZERS



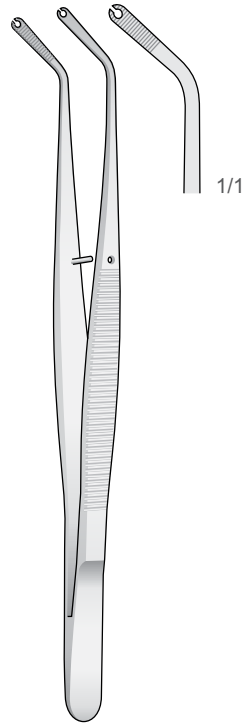
Naht- und Membranpinzette - Suture and membrane Forceps  
 Pinzette per sutura e membrana - Pinzas para suturas y membranas  
 Pincettes à suture et à membrane

Pinzetten  
 Forceps  
 Pinzette  
 Pinzas  
 Pincés

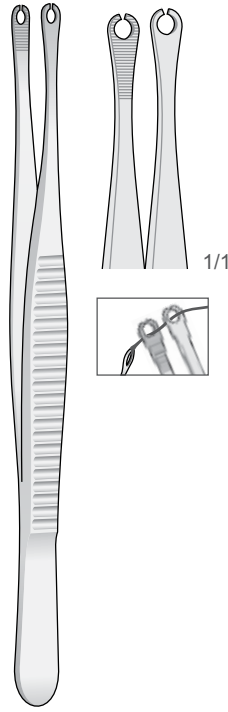


Ø Int 1.6 mm  
 1/1  
**BD-158**  
 Ø Int 2.2 mm  
 1/1  
**BD-159**

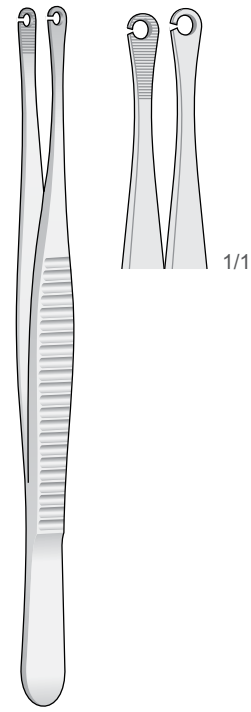
**BD-158/BD-159**  
 160 mm



**CORN DA-07**  
 150 mm

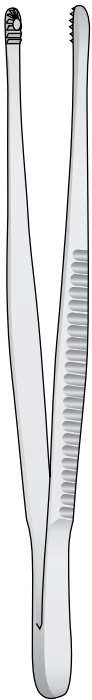


**DA-06**  
 150 mm

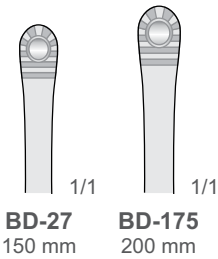


**DA-08**  
 150 mm

Artikulationspapier-Pinzetten - Articulating Paper Forceps  
 Pinza per carta articolazione - Pinzas para papel de articular  
 Pince pour papier à articuler

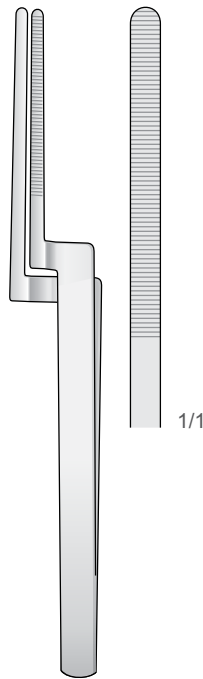


**RUSSIAN BD-27/BD-175**

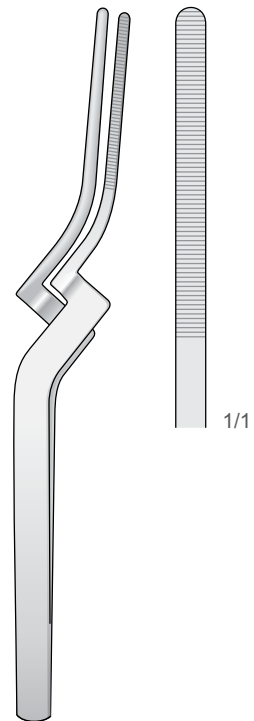


**BD-27**  
 150 mm

**BD-175**  
 200 mm



**MILLER DR-78**  
 145 mm



**MILLER DR-80**  
 160 mm





we take a closer look

# DRIVERS



Needle Holders

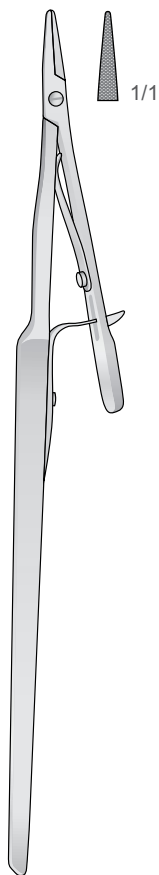


Nadelhalter  
 Needle Holders  
 Port'aghi  
 Portaaguja  
 Porte aiguilles

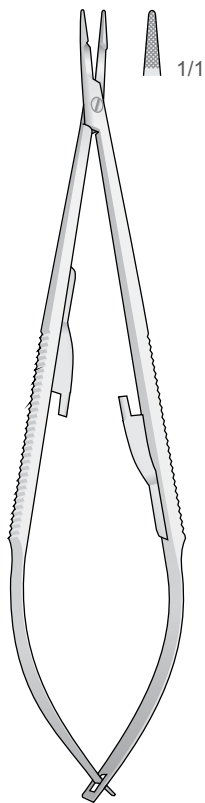
NEEDLE  
 HOLDERS

Mit Scheren  
 With Scissor  
 Con forbice  
 Con tijeras  
 Avec ciseaux

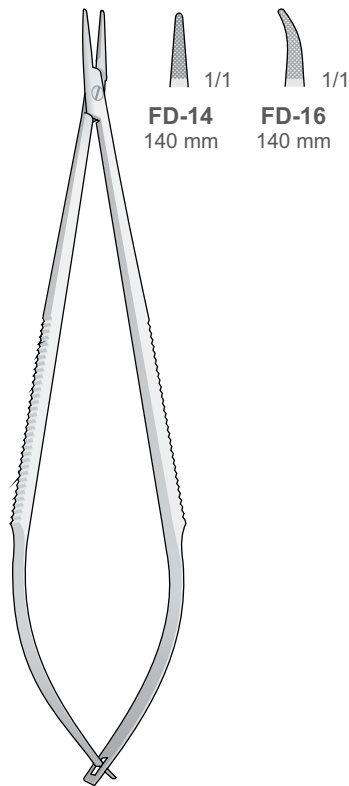
Glattes Maul  
 Smooth Jaw  
 Morso liscio  
 Mandibula lisa  
 Mors lisse



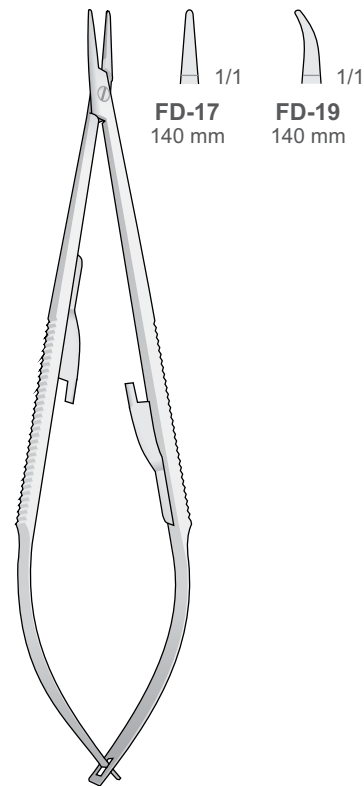
STEVENS  
**FD-38**  
 160 mm



**FD-26**  
 140 mm



**FD-14/FD-16**  
 140 mm



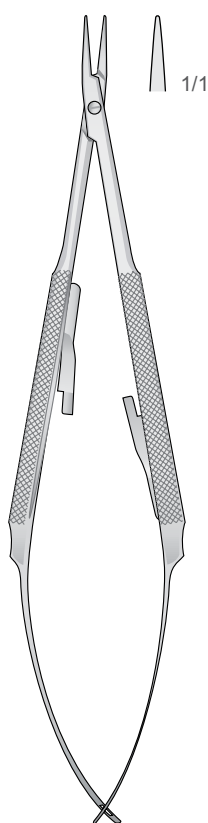
CASTROVIEJO  
**FD-17/FD-19**  
 140 mm



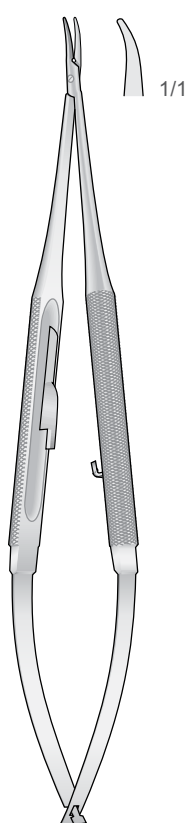
Mit Locking-System  
With Locking System (stop)  
Con sistema di bloccaggio  
Con sistema de bloqueo  
Avec système de verrouillage

Glattes Maul  
Smooth Jaw  
Morso liscio  
Mandíbula lisa  
Mors lisse

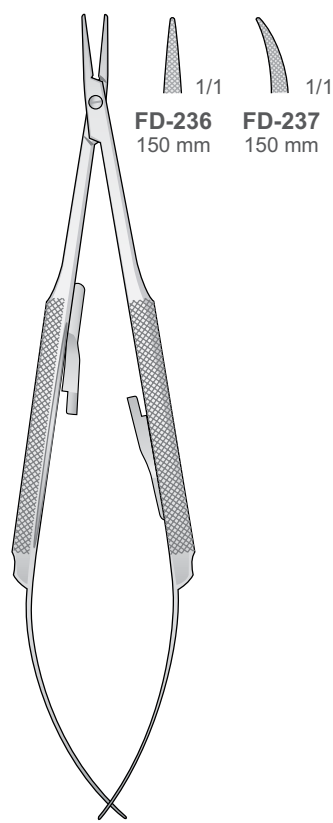
Feingerieftes Maul  
Fine serrated jaws  
Morso zigrinato fine  
Mandíbula estriada fina  
Mors strié fin



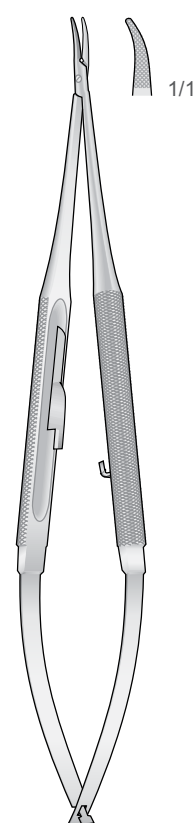
BARRAQUER  
FD-216  
150 mm



BARRAQUER  
FD-217  
150 mm



BARRAQUER  
FD-236/FD-237  
150 mm



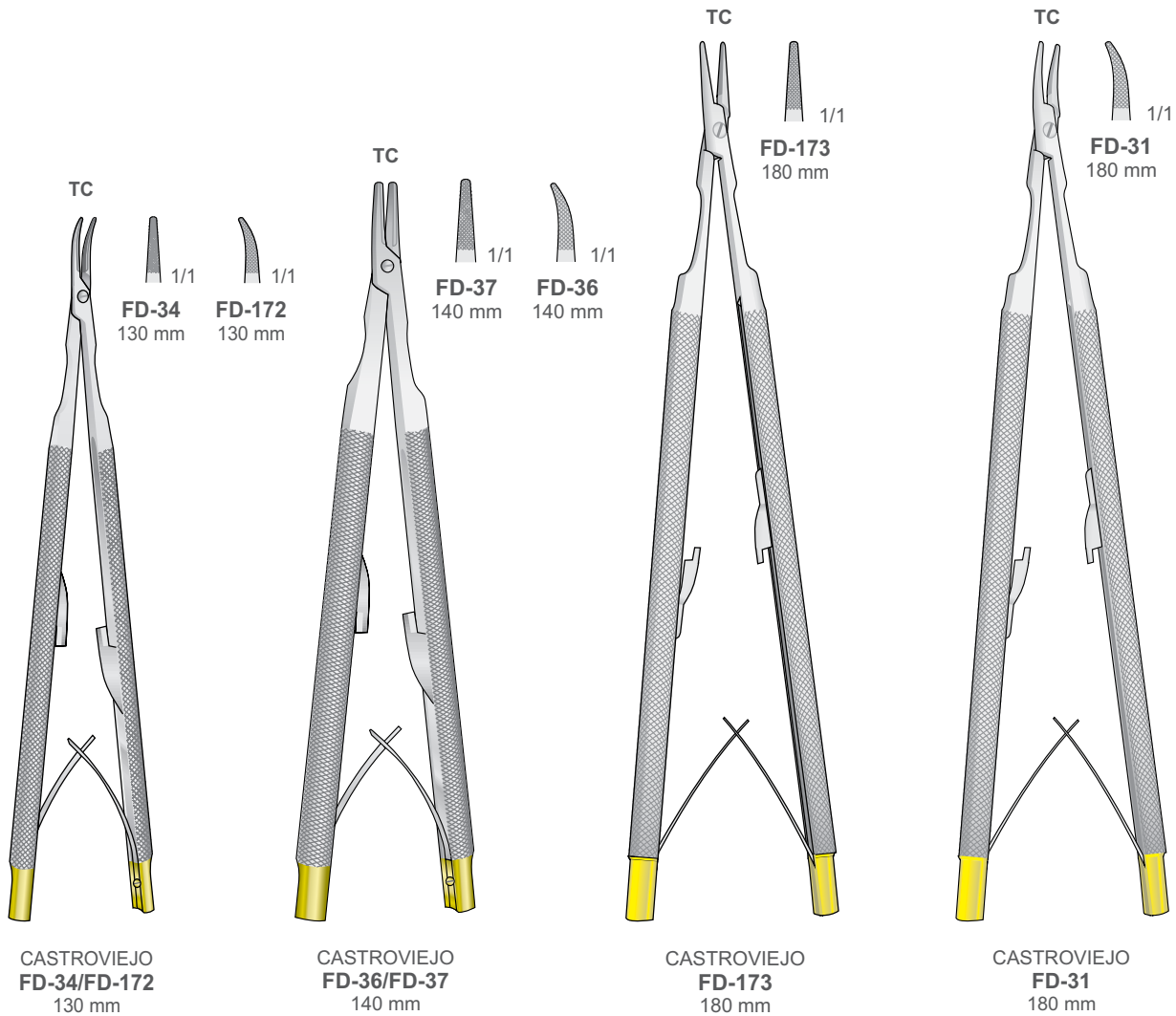
BARRAQUER  
FD-24  
150 mm

Nadelhalter  
 Needle Holders  
 Port'aghi  
 Portaaguja  
 Porte aiguilles

**TC**  
**TUNGSTEN**  
**CARBIDE**

**Tungsten-Carbide Inserts**  
 Mit Hartmetalleinsätzen  
 Plaquettes en carbure de tungstène  
 Plaquetas de carburo de tungsteno  
 Inserti in carburo di tungsteno

NEEDLE  
 HOLDERS

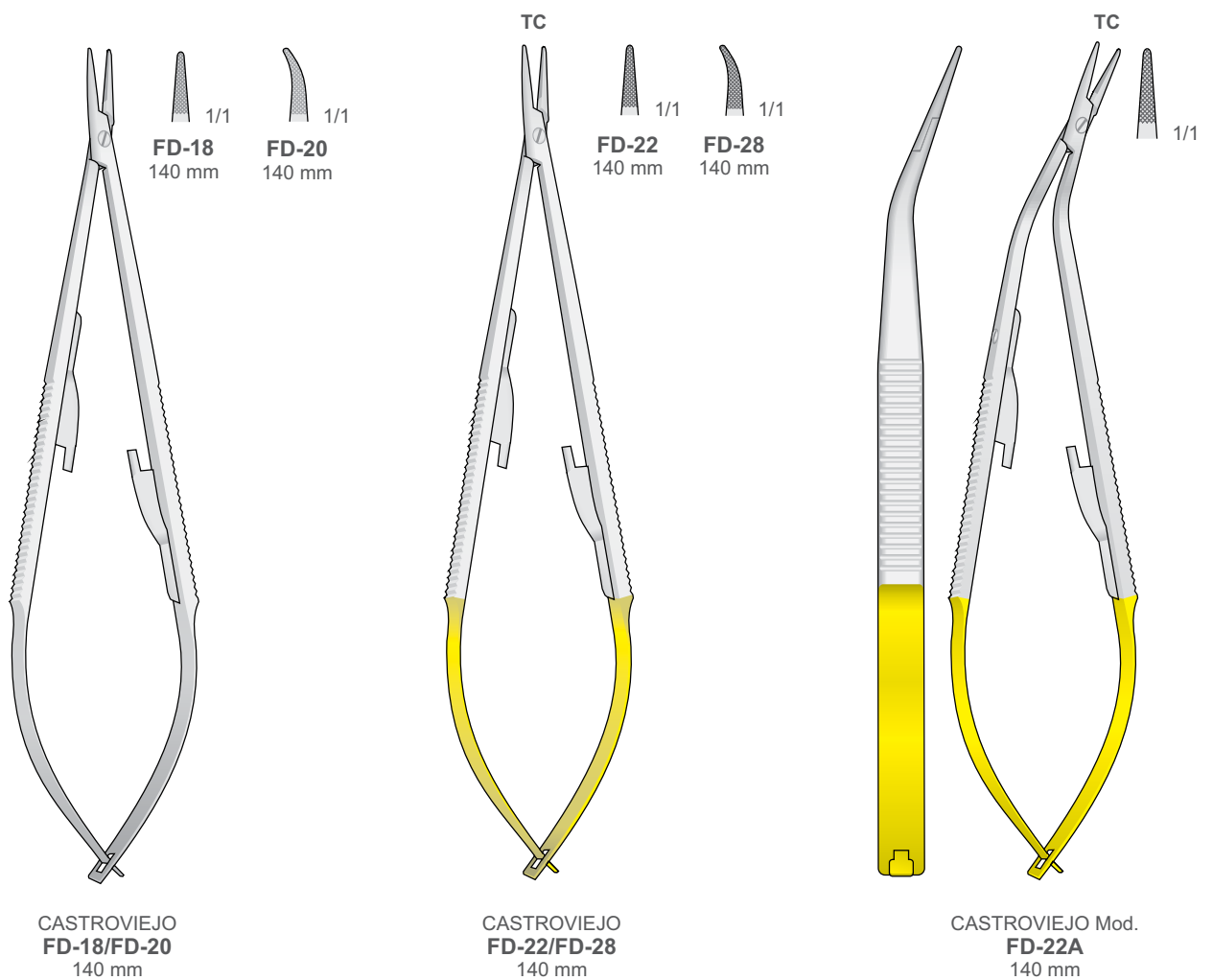


Nadelhalter  
Needle Holders  
Port'aghi  
Portaagujas  
Porte aiguilles



**Tungsten-Carbide Inserts**  
Mit Hartmetalleinsätzen  
Plaquettes en carbure de tungstène  
Plaquetas de carburo de tungsteno  
Inserti in carburo di tungsteno

NEEDLE  
HOLDERS

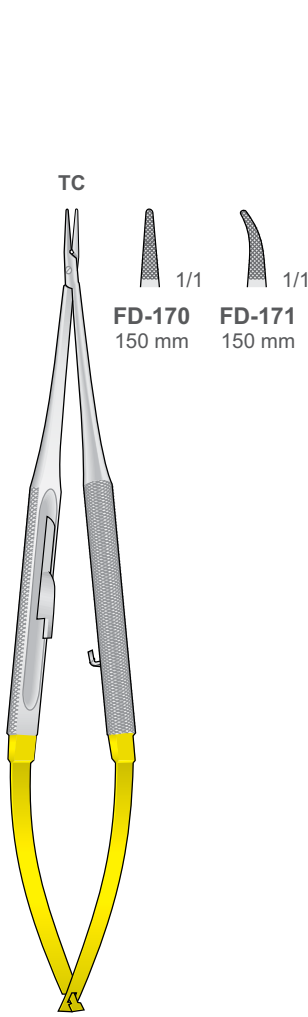




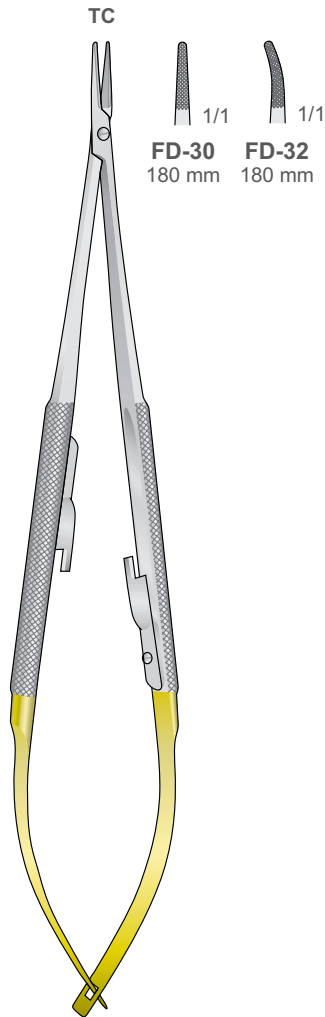
Nadelhalter  
 Needle Holders  
 Port'aghi  
 Portaagujas  
 Porte aiguilles



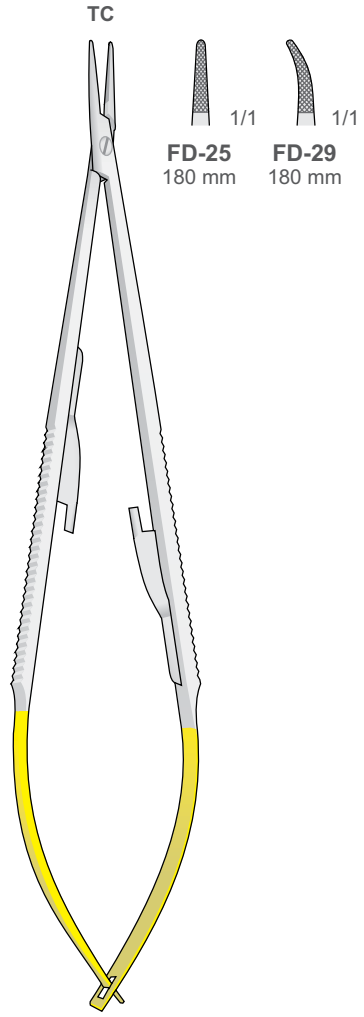
**Tungsten-Carbide Inserts**  
 Mit Hartmetalleinsätzen  
 Plaquettes en carbure de tungstène  
 Plaquetas de carburo de tungsteno  
 Inserti in carburo di tungsteno



JACOBSON  
**FD-170/FD-171**  
 150 mm



JACOBSON  
**FD-30/FD-32**  
 180 mm



CASTROVIEJO  
**FD-25/FD-29**  
 180 mm

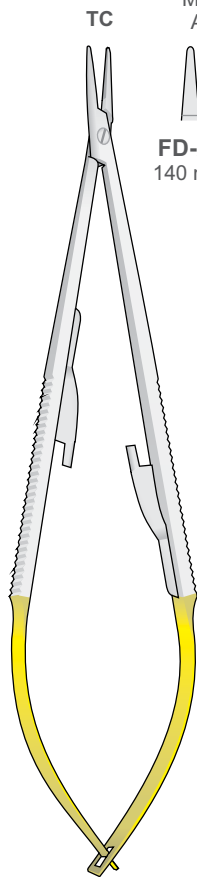
NEEDLE  
 HOLDERS



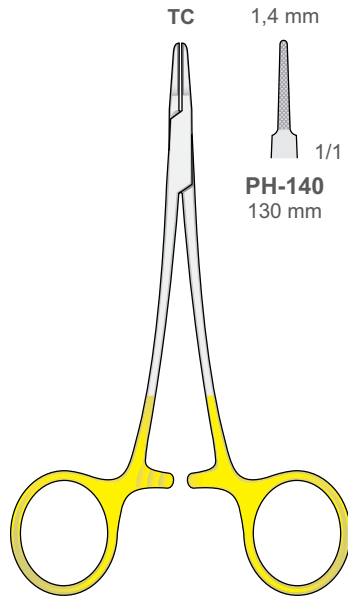
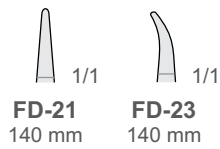


**Tungsten-Carbide Inserts**  
Mit Hartmetalleinsätzen  
Plaquettes en carbure de tungstène  
Plaquetas de carburo de tungsteno  
Inserti in carburo di tungsteno

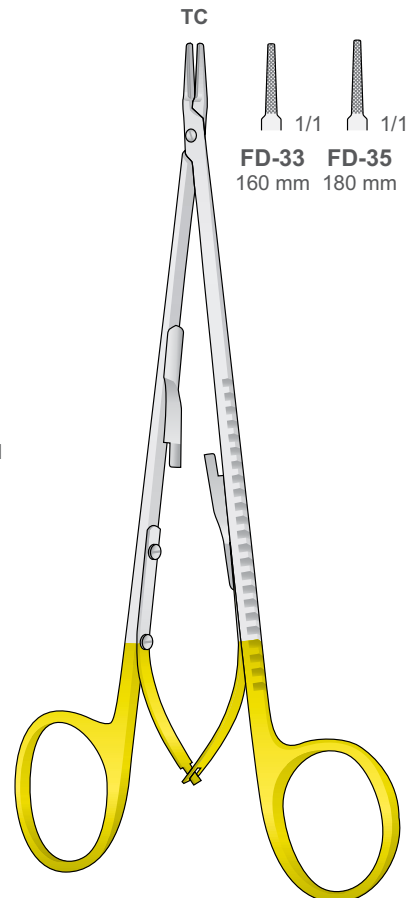
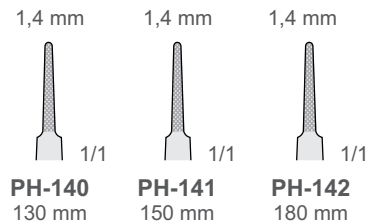
Glattes Maul  
Smooth jaws  
Con morso liscio  
Mandibula lisa  
A' mors lisse



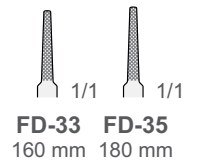
**CASTROVIEJO**  
**FD-21/FD-23**  
140 mm



**MICRO-RYDER**  
**PH-140/PH-141/PH-142**



**DIETRICH**  
**FD-33/FD-35**



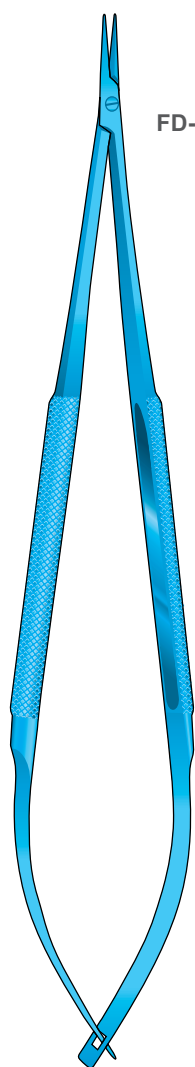
Mikro Nadelhalter - Mikro Scheren  
 Micro Needle Holders - Micro Scissors  
 Micro Port'aghi - Micro Forbici  
 Micro Portaagujas - Micro Tijeras  
 Micro Porte aiguilles - Micro Ciseaux





Rund-Griffe Ø 8 mm  
 Round handle Ø 8 mm  
 Manico rotondo Ø 8 mm  
 Mango redondo Ø 8 mm  
 Manche rond Ø 8 mm

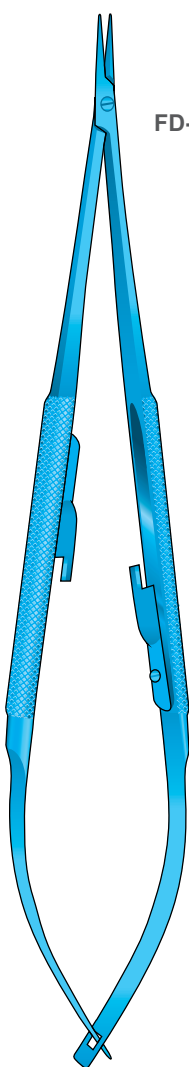
Mikro Nadelhalter  
 Micro Needle Holders  
 Micro port'aghi  
 Micro portaagujas  
 Micro porte aiguilles



Mikro Scheren  
 Micro Scissors  
 Micro forbici  
 Micro tijeras  
 Micro ciseaux



 1/1  1/1  
 FD-562T FD-563T

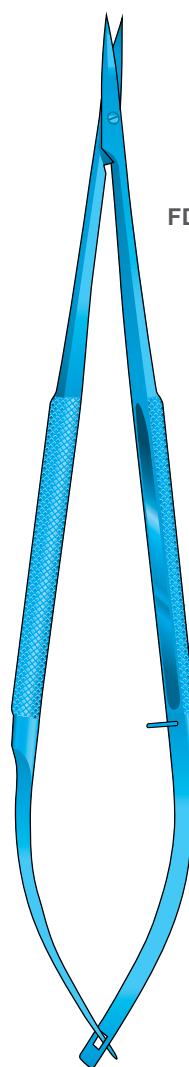
FD-562T/FD-563T  
 180 mm

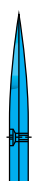



 1/1  1/1  
 FD-574T FD-575T

Mit Sperre  
 With Lock  
 Con arresto  
 Con cierre  
 Avec Arrêt

FD-574T/FD-575T  
 180 mm



 1/1  1/1  
 FD-587T FD-588T

FD-587T/FD-588T  
 180 mm

NEEDLE  
 HOLDERS



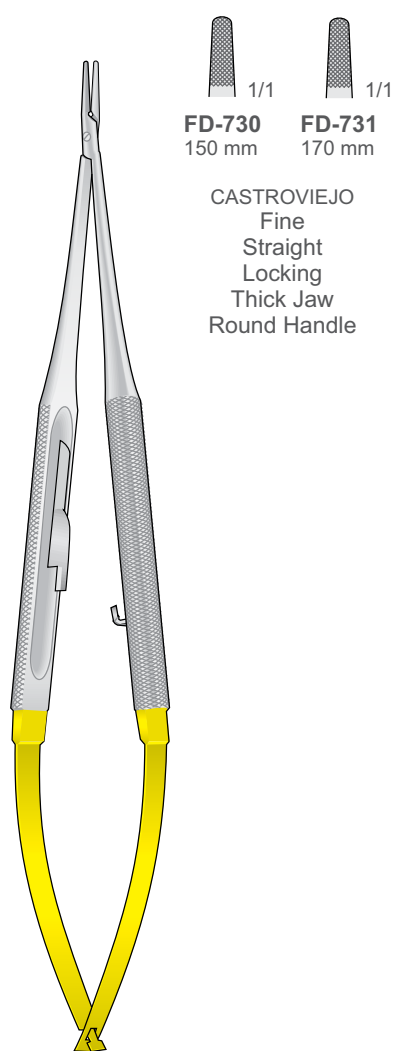


**Tungsten-Carbide Inserts**  
Mit Hartmetalleinsätzen  
Plaquettes en carbure de tungstène  
Plaquetas de carburo de tungsteno  
Inserti in carburo di tungsteno



**Diamond Tip**  
Diamantiert  
Punta diamantata  
Punta de diamante  
Pointe de diamant

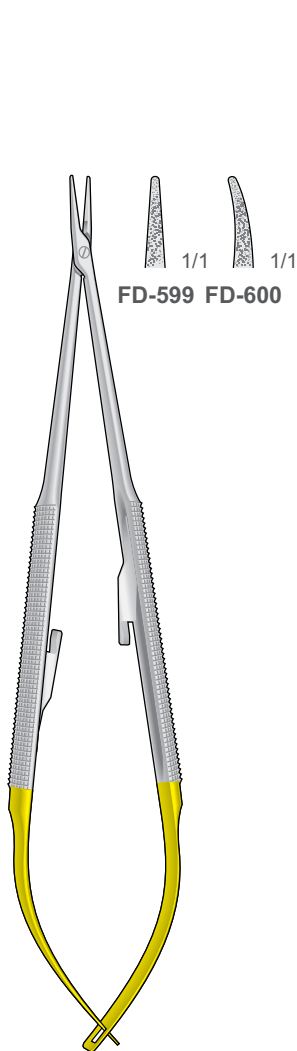
NEEDLE  
HOLDERS



1/1 1/1  
**FD-730** **FD-731**  
150 mm 170 mm

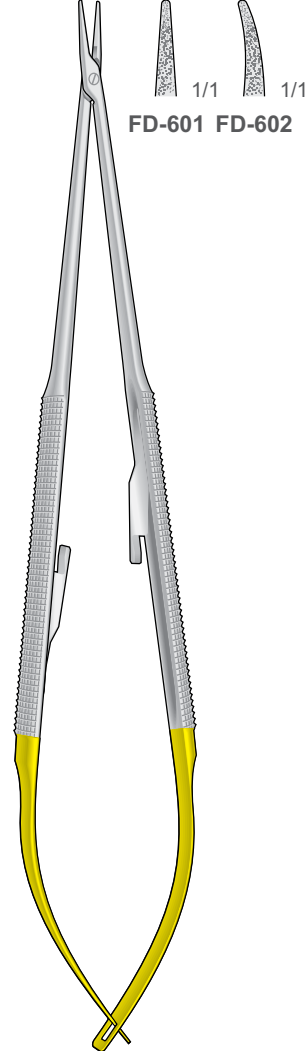
CASTROVIEJO  
Fine  
Straight  
Locking  
Thick Jaw  
Round Handle

CASTROVIEJO  
**FD-730 / FD-731**  
150 / 170 mm



1/1 1/1  
**FD-599** **FD-600**

**FD-599/FD-600**  
150 mm

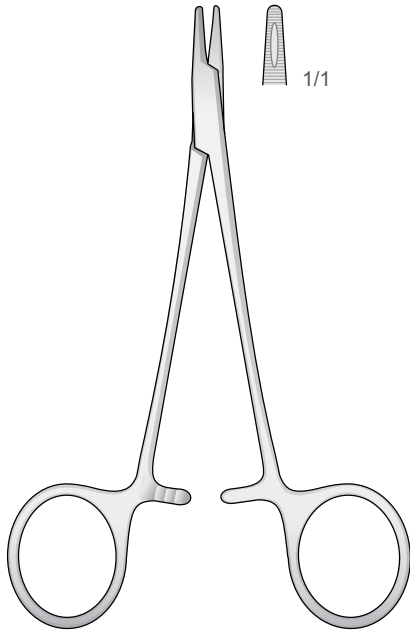


1/1 1/1  
**FD-601** **FD-602**

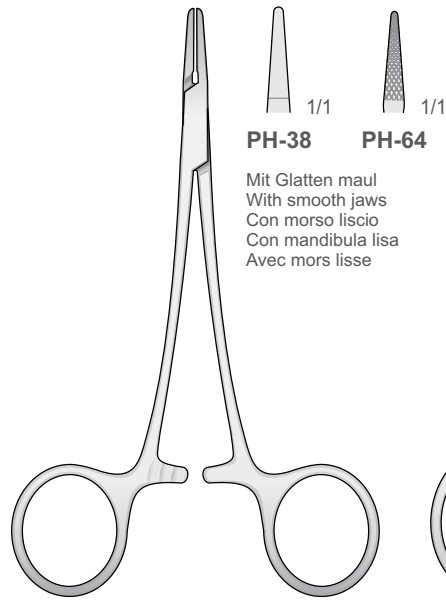
**FD-601/FD-602**  
180 mm



Nadelhalter  
 Needle Holders  
 Port'aghi  
 Portaaguja  
 Porte aiguilles

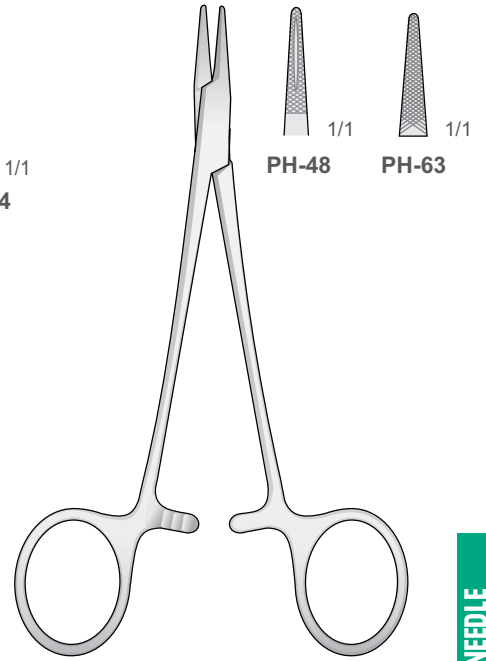


DERF  
**PH-39**  
 125 mm



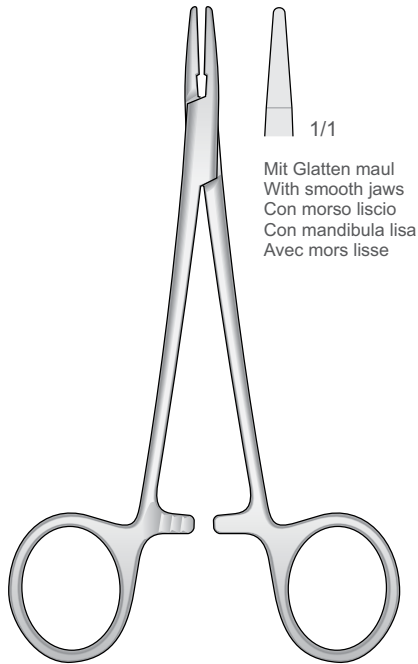
**PH-38**    **PH-64**  
 Mit Glatten maul  
 With smooth jaws  
 Con morso liscio  
 Con mandibula lisa  
 Avec mors lisse

**PH-38/PH-64**  
 120 mm



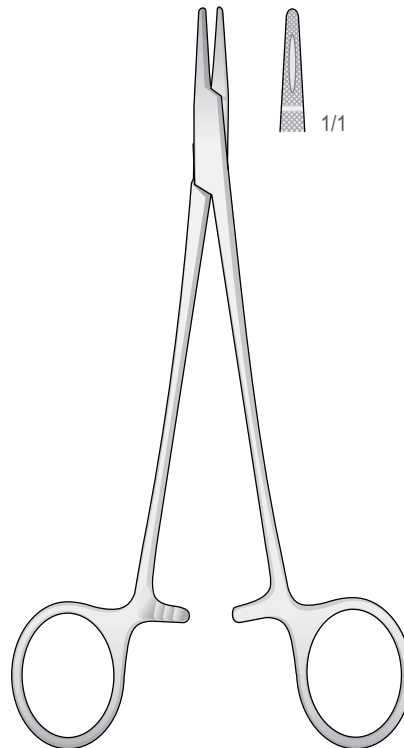
HALSEY  
**PH-48/PH-63**  
 130 mm

NEEDLE  
 HOLDERS

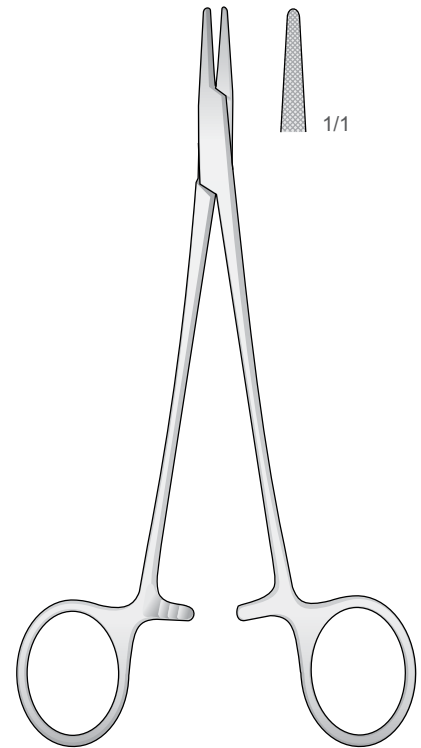


Mit Glatten maul  
 With smooth jaws  
 Con morso liscio  
 Con mandibula lisa  
 Avec mors lisse

HALSEY  
**PH-37**  
 130 mm

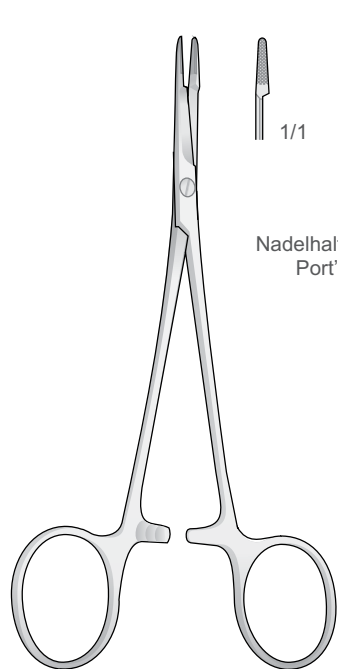


CRILE-WOOD  
**PH-61**  
 150 mm



CRILE-MURRAY  
**PH-62**  
 150 mm



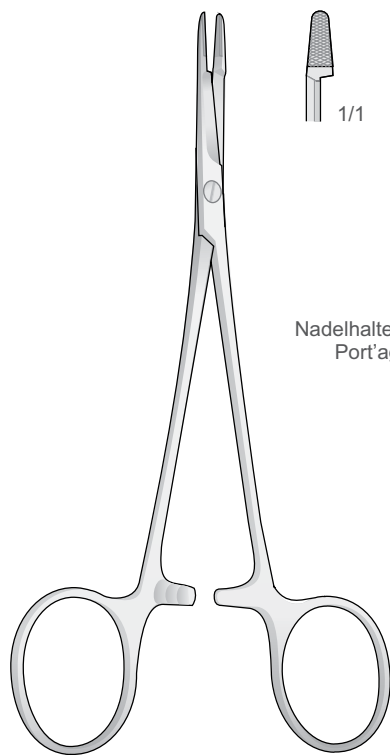


MINI-OLSEN-HEGAR  
**BM-61**  
 120 mm

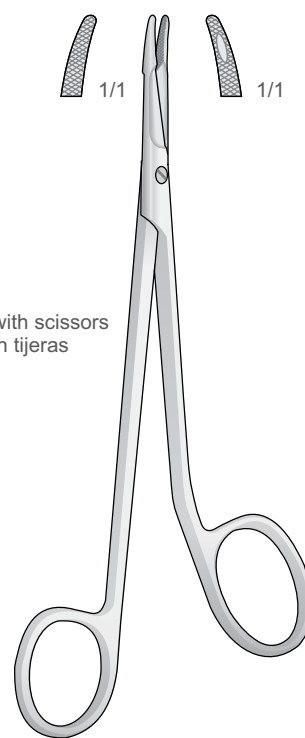


OLSEN-HEGAR  
**BM-62**  
 140 mm

Nadelhalter mit Schere - Needle holders with scissors  
 Port'aghi con forbici - Portaagujas con tijeras  
 Porte aiguilles avec ciseaux



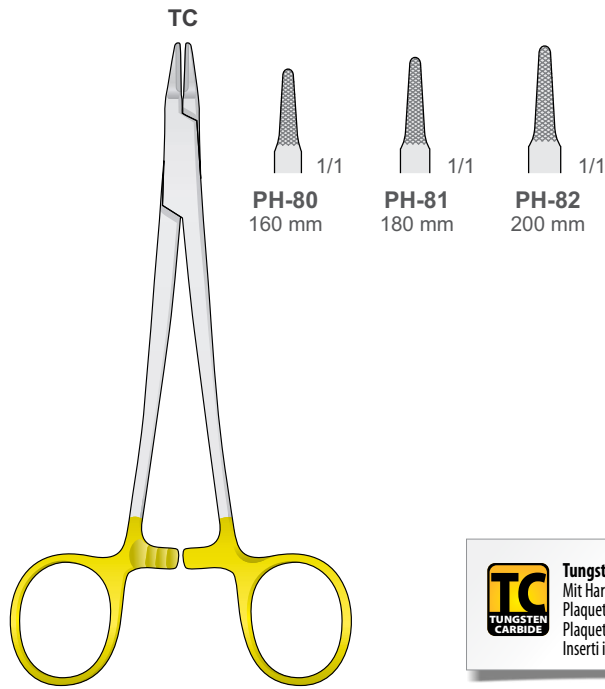
OLSEN-HEGAR  
**BM-63**  
 170 mm



MINI-GILLIES  
**PO-59**  
 145 mm

Nadelhalter mit Schere - Needle holders with scissors  
 Port'aghi con forbici - Portaagujas con tijeras  
 Porte aiguilles avec ciseaux

Nadelhalter  
Needle Holders  
Port'aghi  
Portaagujas  
Porte aiguilles

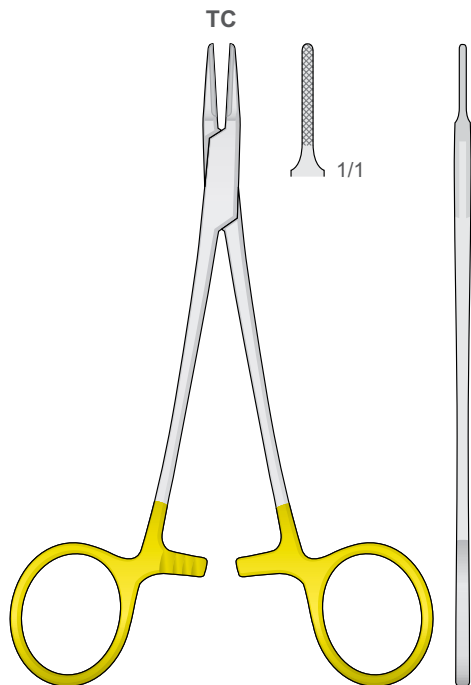


RYDER  
PH-80/PH-82

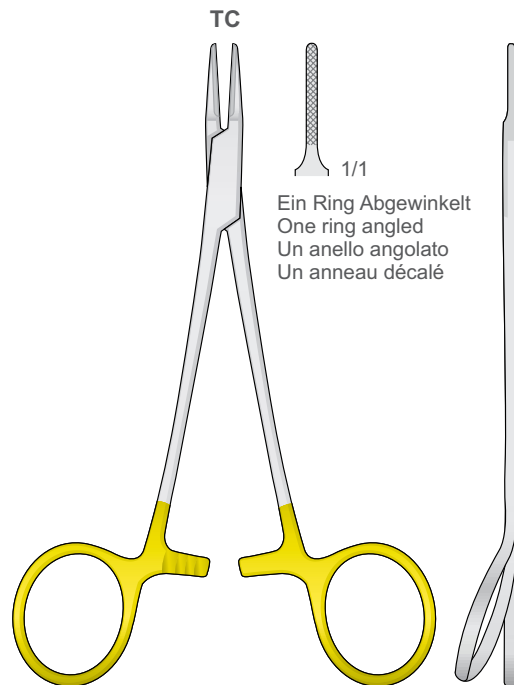
**TC**  
TUNGSTEN  
CARBIDE

**Tungsten-Carbide Inserts**  
Mit Hartmetalleinsätzen  
Plaquettes en carbure de tungstène  
Plaquetas de carburo de tungsteno  
Inserti in carburo di tungsteno

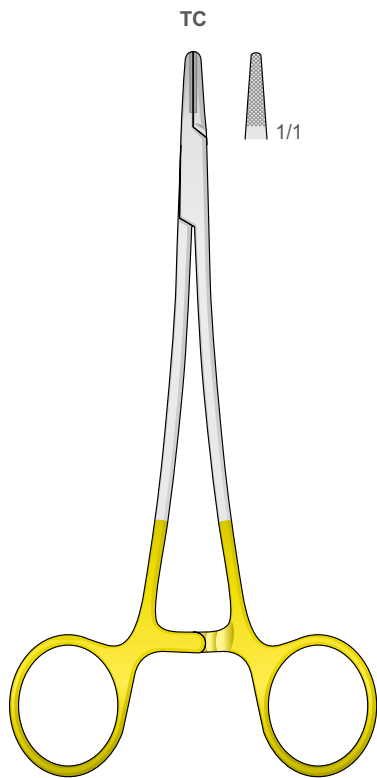
NEEDLE  
HOLDERS



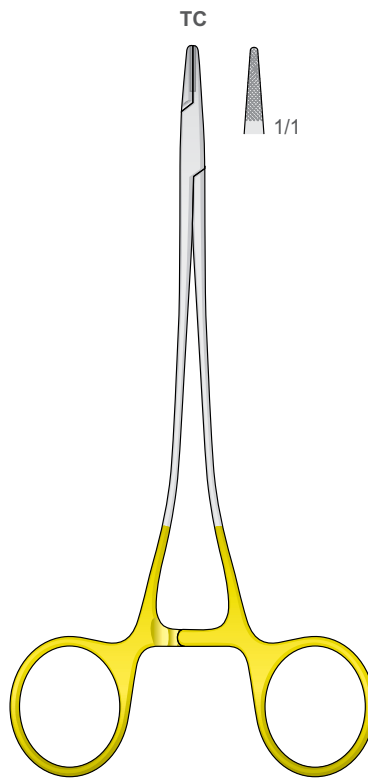
RYDER  
PH-83  
140 mm



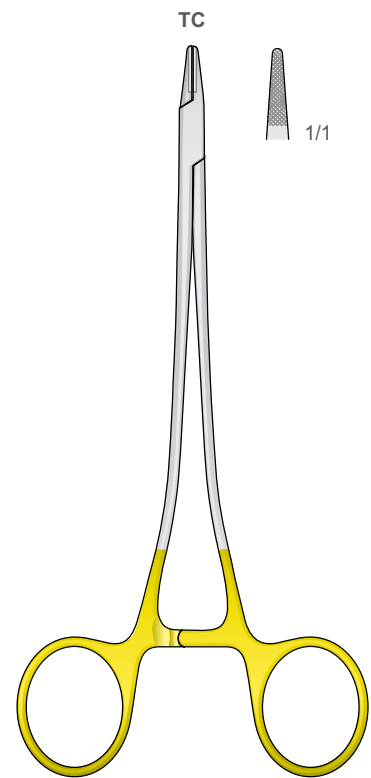
PH-84  
140 mm



CRILE-WOOD  
**PH-79**  
145 mm



FINE SWEDISH PATTERN  
**PH-85**  
150 mm



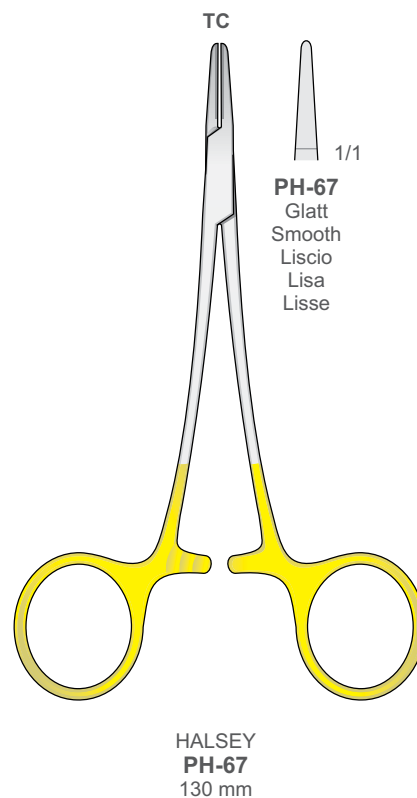
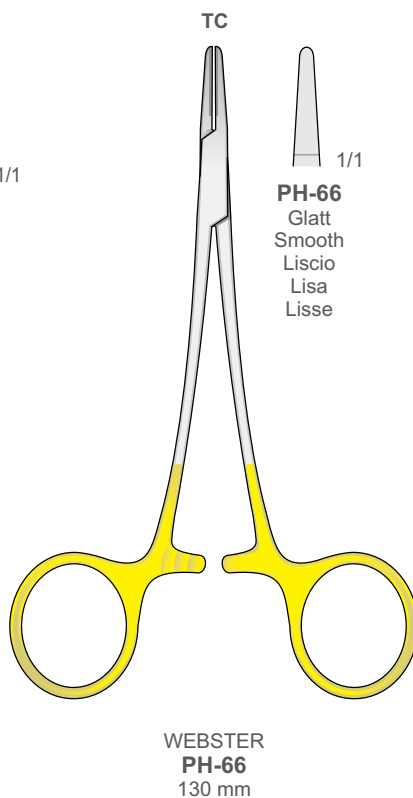
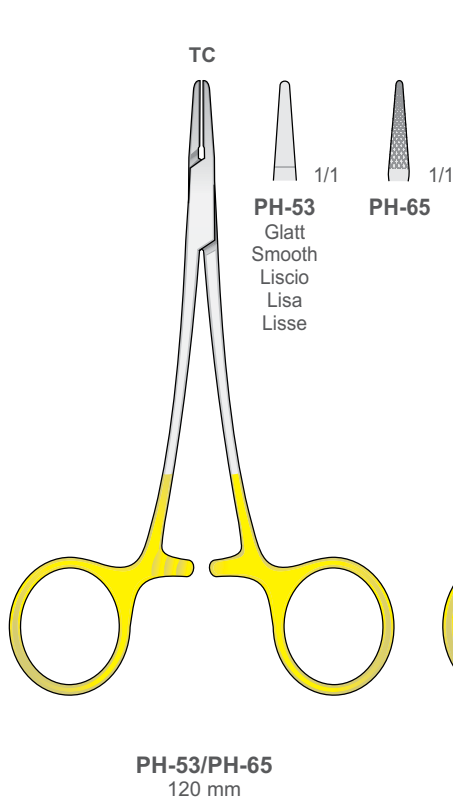
SWEDISH MOD.  
**PH-106**  
150 mm



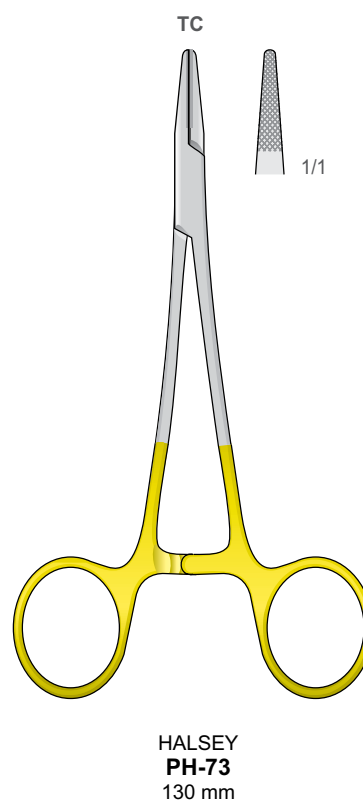
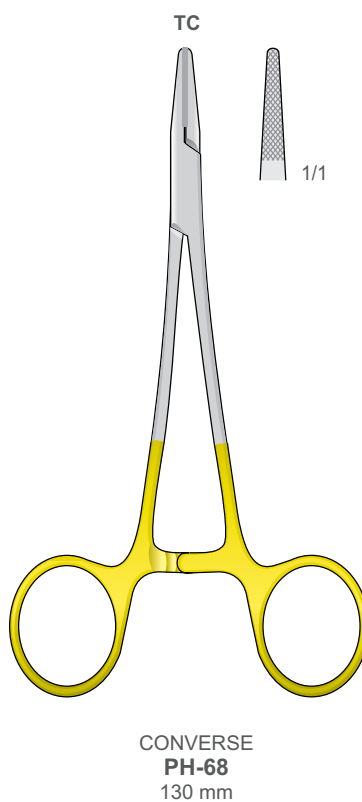
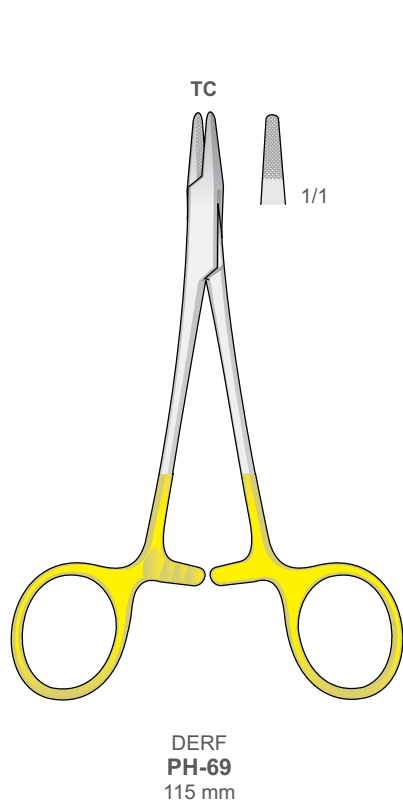
Nadelhalter  
Needle Holders  
Port'aghi  
Portaagujas  
Porte aiguilles

**TC**  
TUNGSTEN  
CARBIDE

**Tungsten-Carbide Inserts**  
Mit Hartmetalleinsätzen  
Plaquettes en carbure de tungstène  
Plaquetas de carburo de tungsteno  
Inserti in carburo di tungsteno



NEEDLE  
HOLDERS

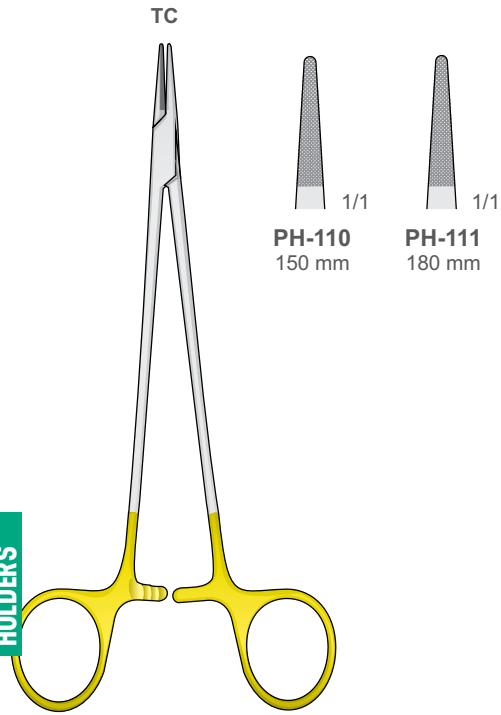




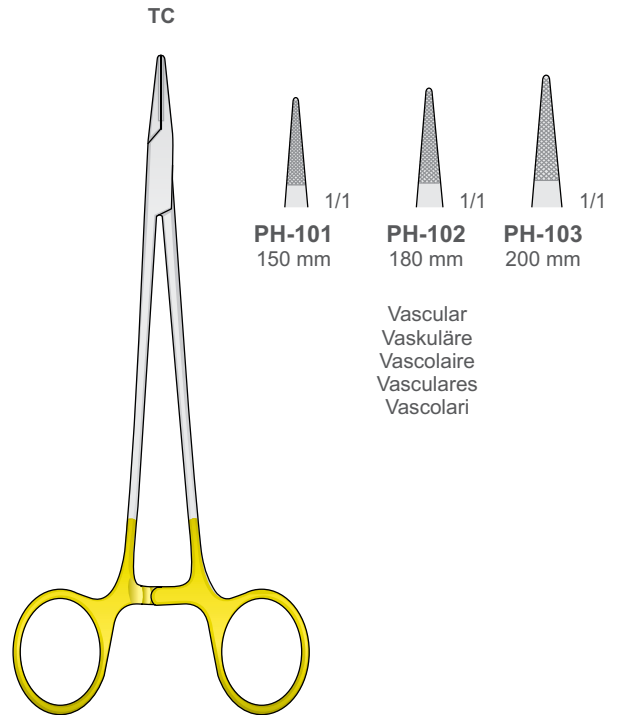
**Tungsten-Carbide Inserts**  
 Mit Hartmetalleinsätzen  
 Plaquettes en carbure de tungstène  
 Plaquetas de carburo de tungsteno  
 Inserti in carburo di tungsteno

Nadelhalter  
 Needle Holders  
 Port'aghi  
 Portaagujas  
 Porte aiguilles

NEEDLE  
 HOLDERS

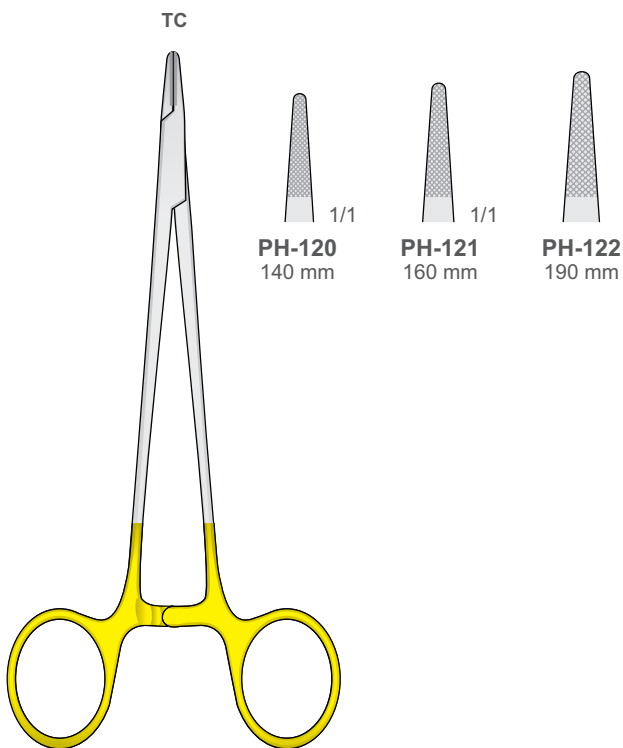


DE BAKEY  
 PH-110/PH-111

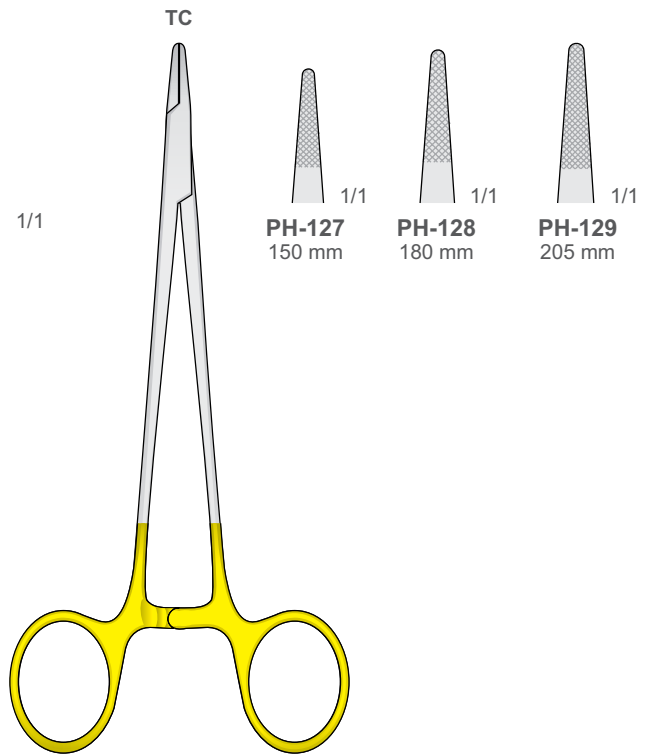


MICRO-VASCULAR  
 PH-101/PH-102/PH-103

Vascular  
 Vaskuläre  
 Vasculaire  
 Vasculares  
 Vascolari



HEGAR  
 PH-120/PH-121/PH-122



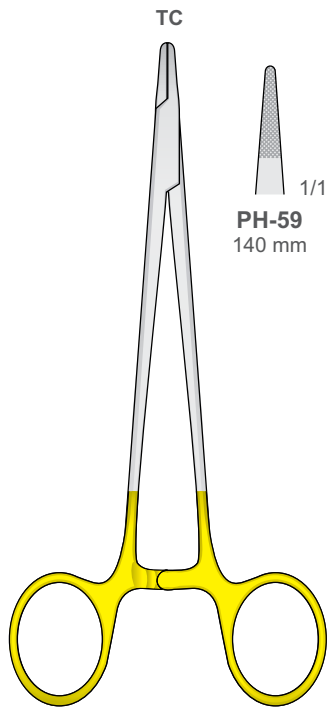
MAYO-HEGAR-FINO  
 PH-127/PH-128/PH-129



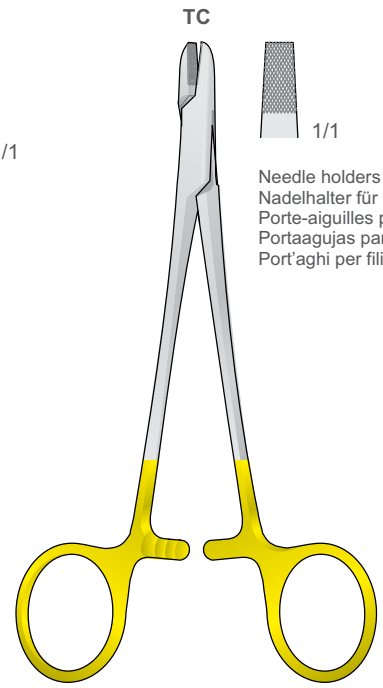
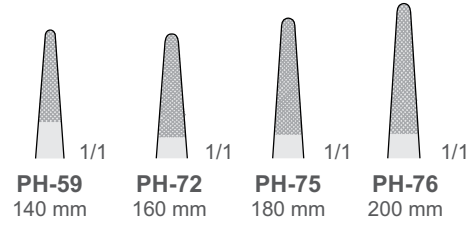
Nadelhalter  
Needle Holders  
Port'aghi  
Portaaguja  
Porte aiguilles

**TC**  
TUNGSTEN  
CARBIDE

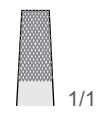
**Tungsten-Carbide Inserts**  
Mit Hartmetalleinsätzen  
Plaquettes en carbure de tungstène  
Plaquetas de carburo de tungsteno  
Inserti in carburo di tungsteno



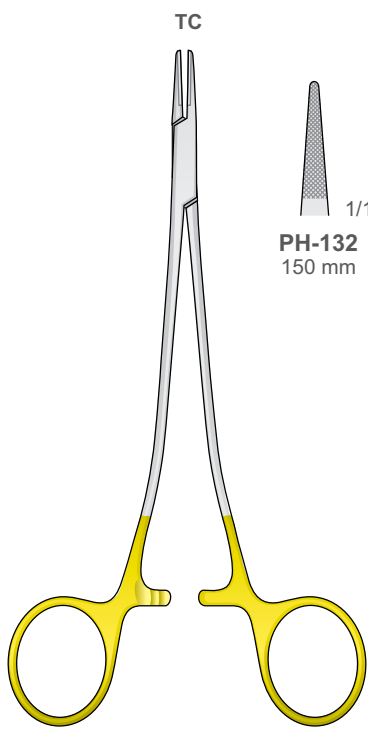
HEGAR  
PH-59/PH-72/PH-75/PH-76



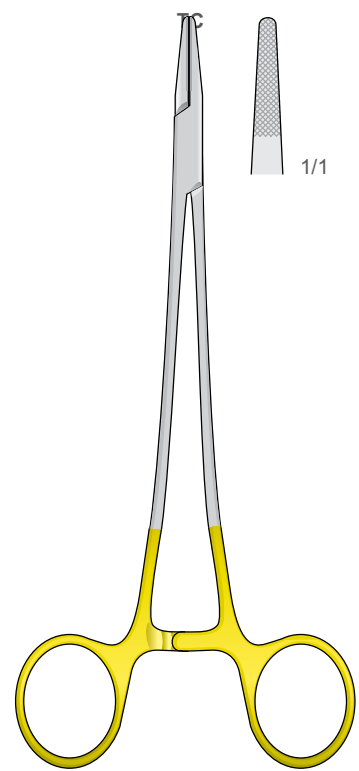
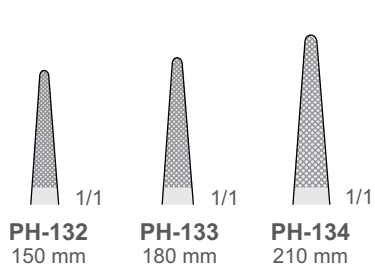
PH-58  
150 mm



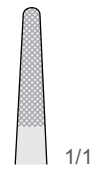
Needle holders for wire  
Nadelhalter für drähte  
Porte-aiguilles pour fil métallique  
Portaaguja para hilo metálico  
Port'aghi per fili metallici



SAROT  
PH-132/PH-133/PH-134



CRILE-WOOD  
PH-77  
180 mm



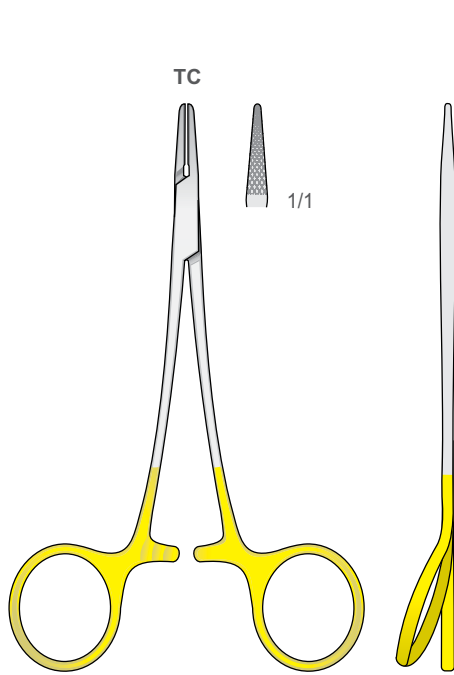
NEEDLE  
HOLDERS



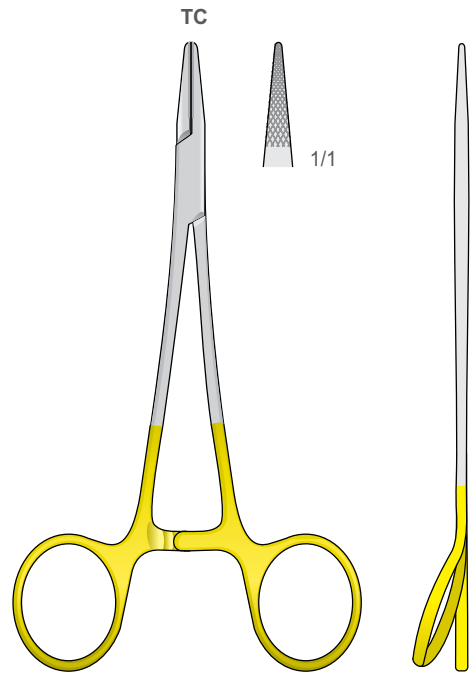


**Tungsten-Carbide Inserts**  
 Mit Hartmetalleinsätzen  
 Plaquettes en carbure de tungstène  
 Plaquetas de carburo de tungsteno  
 Inserti in carburo di tungsteno

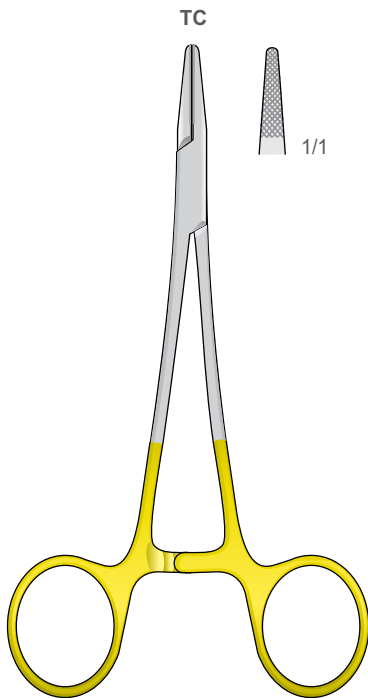
Nadelhalter  
 Needle Holders  
 Port'aghi  
 Portaagujas  
 Porte aiguilles



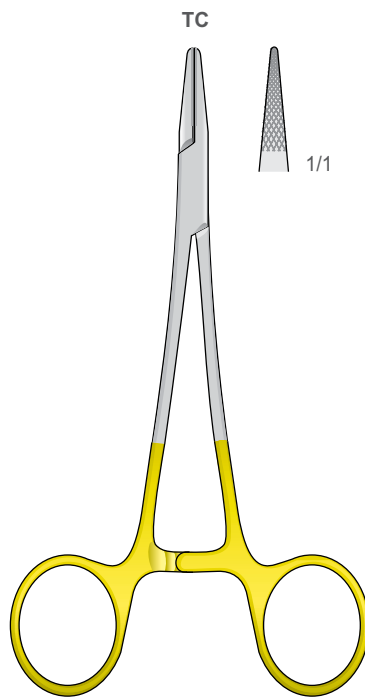
**PH-99**  
120 mm



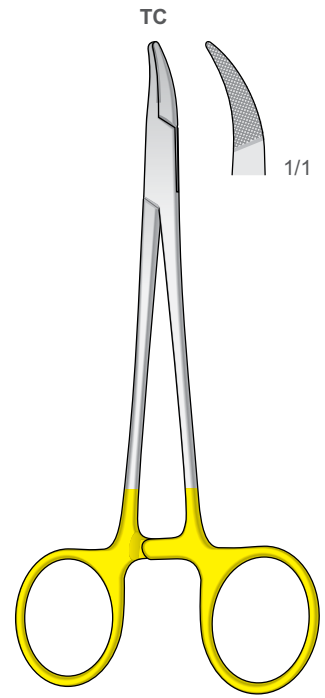
**CRILE-WOOD  
PH-100**  
150 mm



**BABY-CRILE-WOOD  
PH-54**  
150 mm



**CRILE-WOOD  
PH-71**  
150 mm



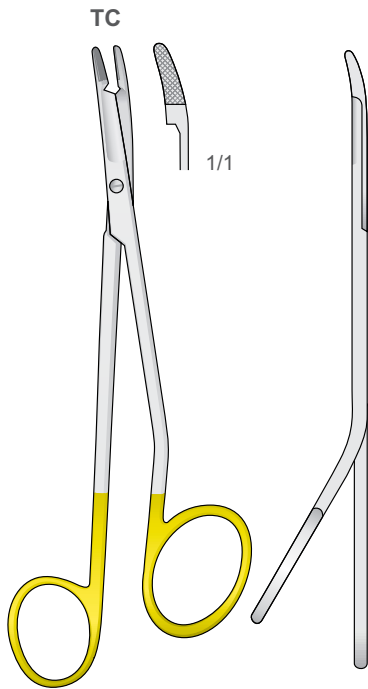
**CRILE-WOOD  
PH-90**  
150 mm



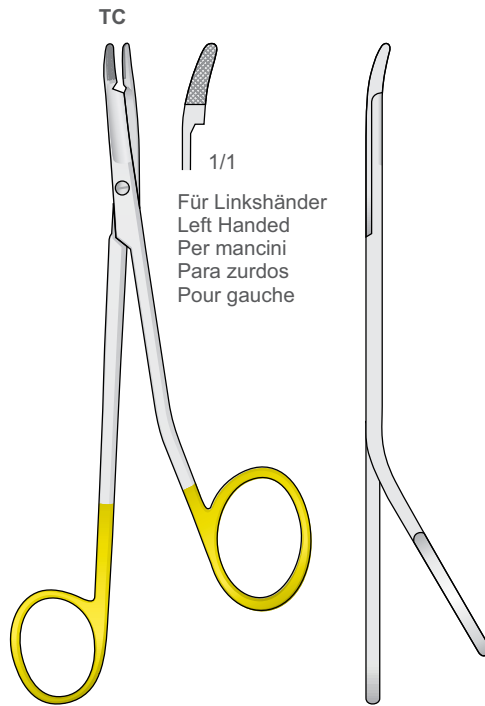
Nadelhalter  
Needle Holders  
Port'aghi  
Portaagujas  
Porte aiguilles

**TC**  
TUNGSTEN  
CARBIDE

**Tungsten-Carbide Inserts**  
Mit Hartmetalleinsätzen  
Plaquettes en carbure de tungstène  
Plaquetas de carburo de tungsteno  
Inserti in carburo di tungsteno

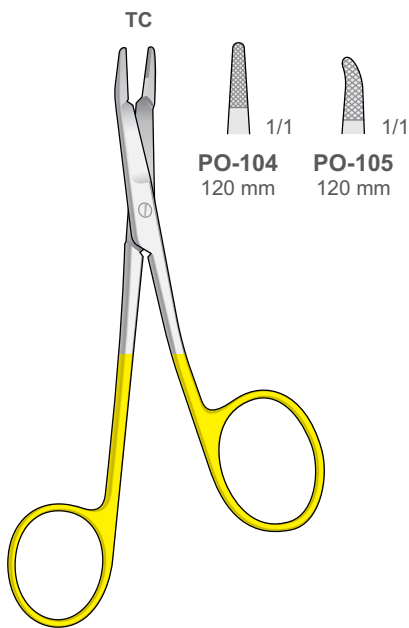


**MINI-GILLIES  
PO-99**  
145 mm

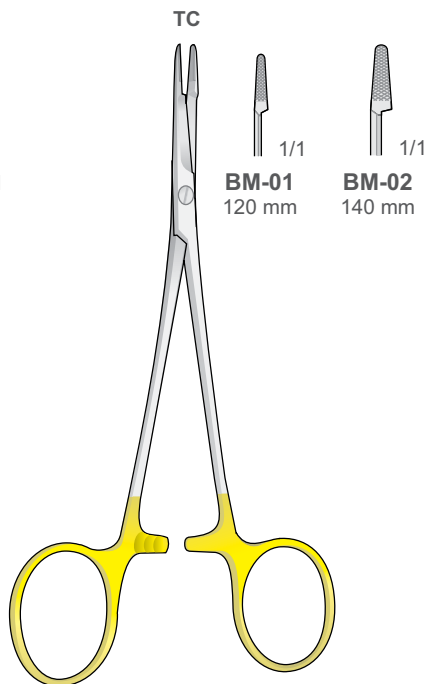


**MINI-GILLIES  
PO-99L**  
145 mm

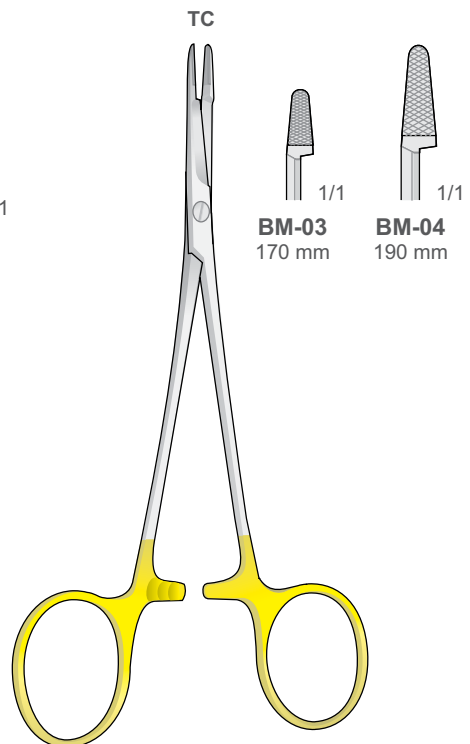
NEEDLE  
HOLDERS



**FOSTER-GILLIES  
PO-104/PO-105**  
120 mm



**OLSEN-HEGAR  
BM-01/BM-02**

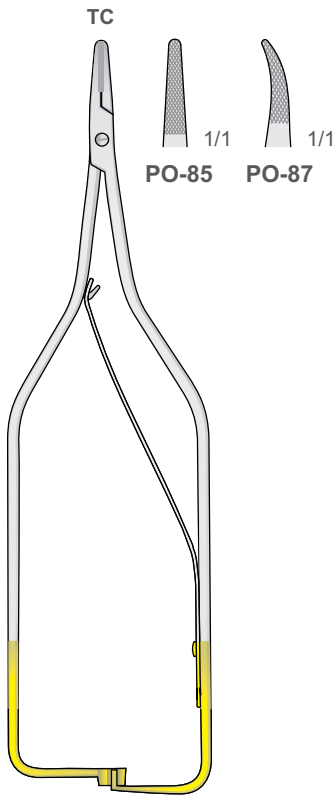


**OLSEN-HEGAR  
BM-03/BM-04**

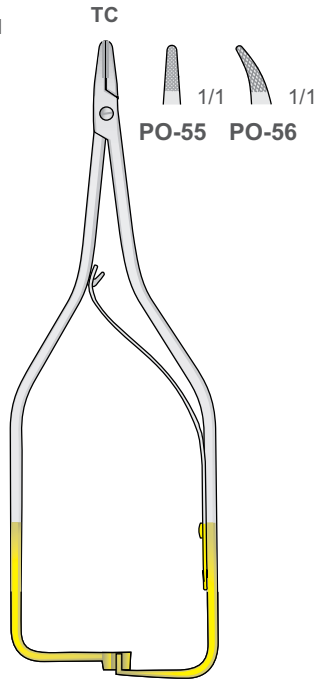


Nadelhalter  
Needle Holders  
Port'aghi  
Portaagujas  
Porte aiguilles

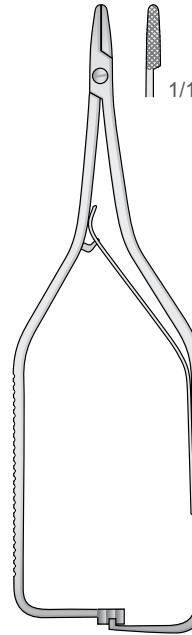
NEEDLE  
HOLDERS



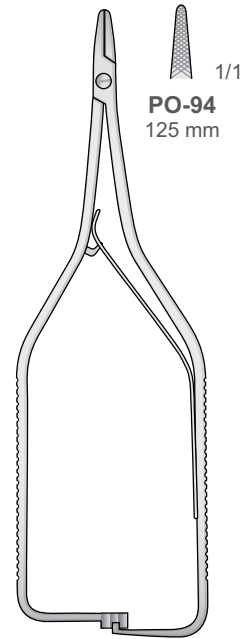
ARRUGA  
PO-85/PO-87  
160 mm



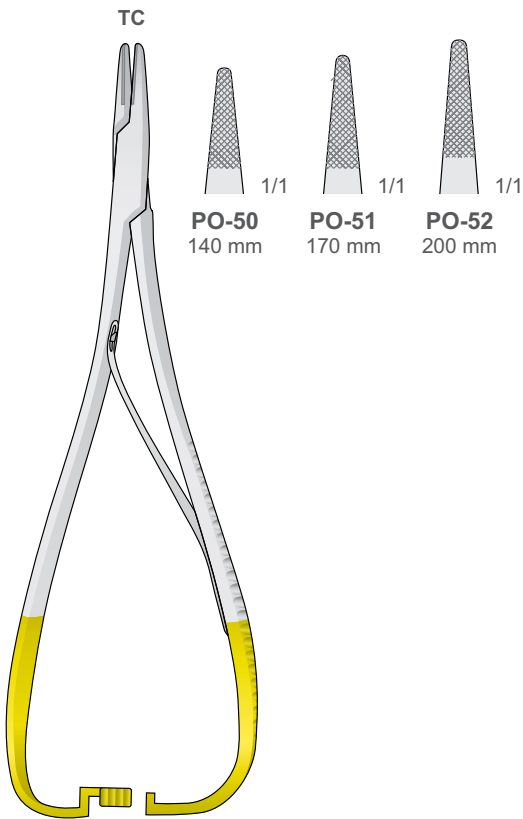
BOYNTON  
PO-55/PO-56  
120 mm



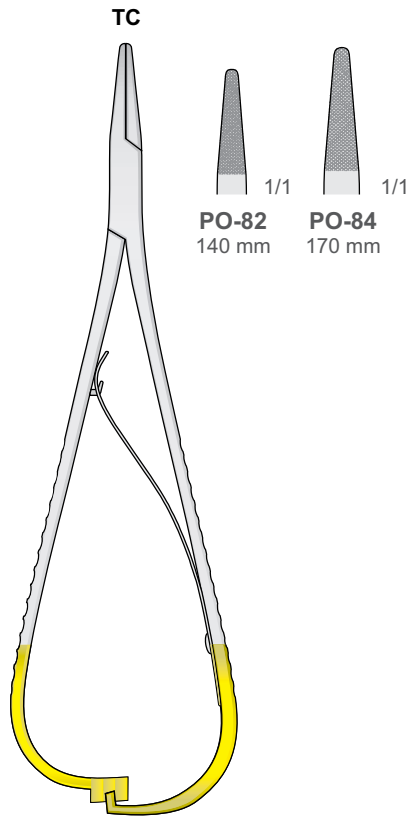
BOYNTON  
PO-88  
120 mm



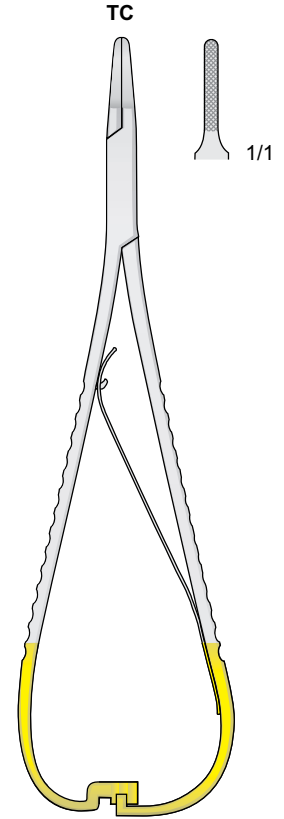
BOYNTON  
PO-94  
125 mm



MATHIEU  
PO-50/PO-52



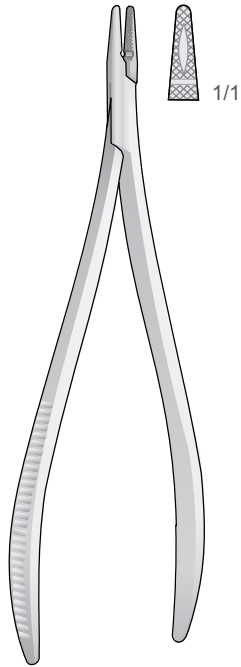
MATHIEU  
PO-82/PO-84



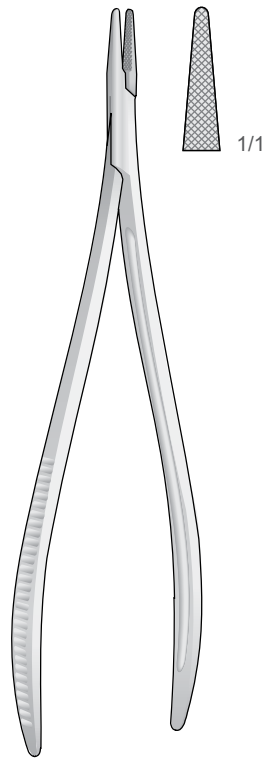
LICHTENBERG  
PO-86  
175 mm



Nadelhalter  
 Needle Holders  
 Port'aghi  
 Portaagujas  
 Porte aiguilles



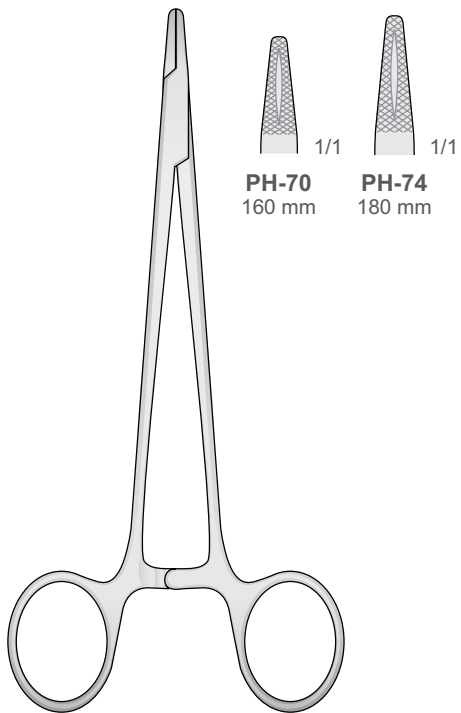
**CRILE**  
**PO-37**  
 150 mm



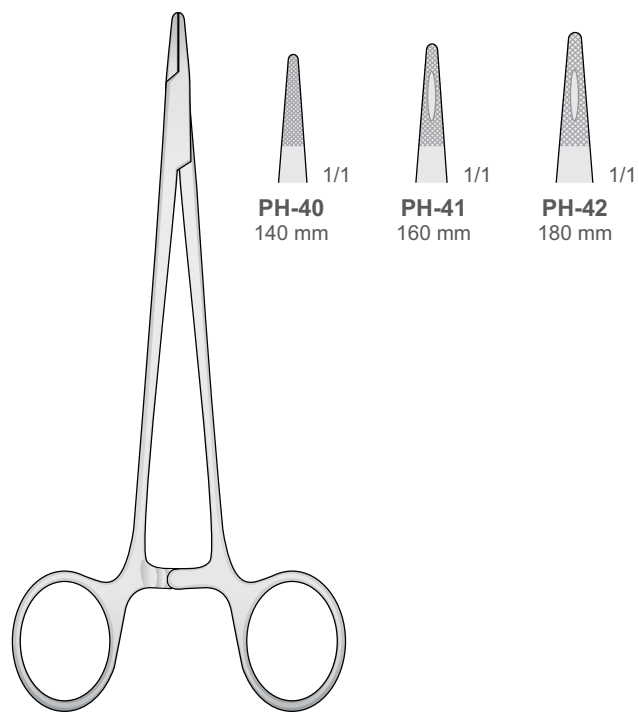
**TÖNNIS**  
**PO-38**  
 190 mm

**NEEDLE  
 HOLDERS**

Schlankesmodell - Delicate pattern - Modello fine  
 Modelo delegado - Modèle fin



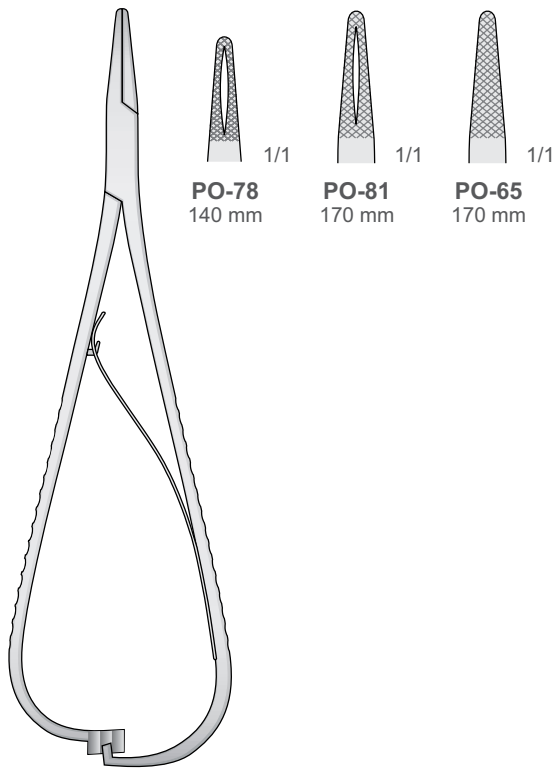
**MAYO-HEGAR**  
**PH-70/PH-74**



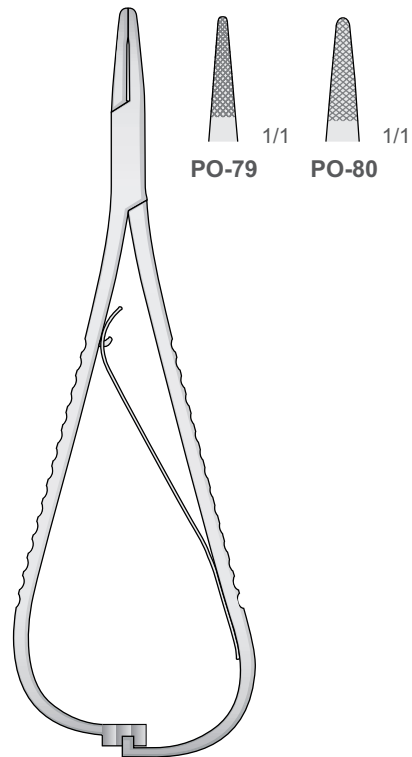
**MAYO-HEGAR**  
**PH-40/PH-42**



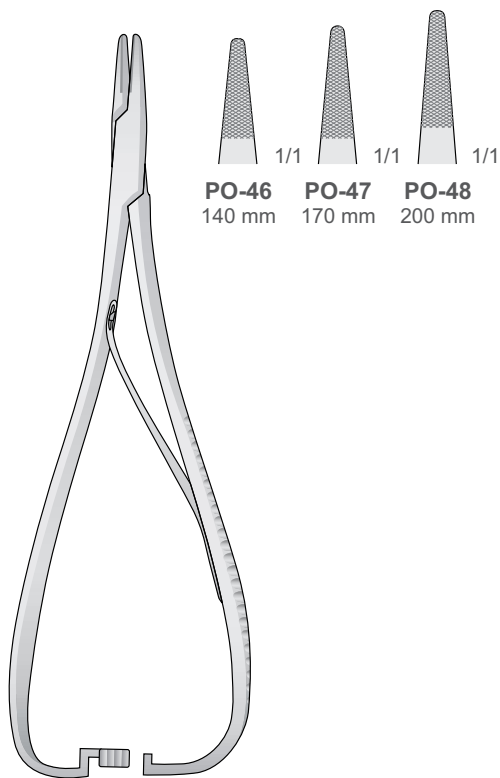
Nadelhalter  
Needle Holders  
Port'aghi  
Portaagujas  
Porte aiguilles



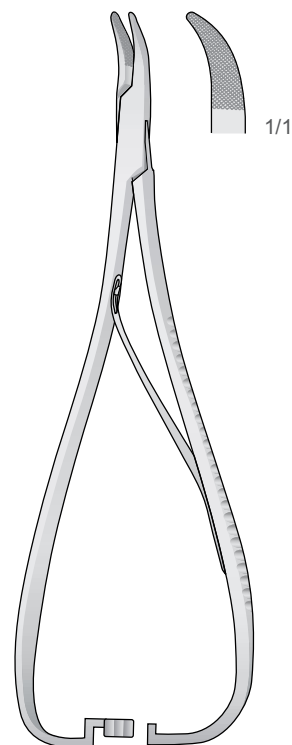
MATHIEU  
PO-65/PO-81



MATHIEU  
PO-79/PO-80  
140 mm



MATHIEU  
PO-46/PO-48



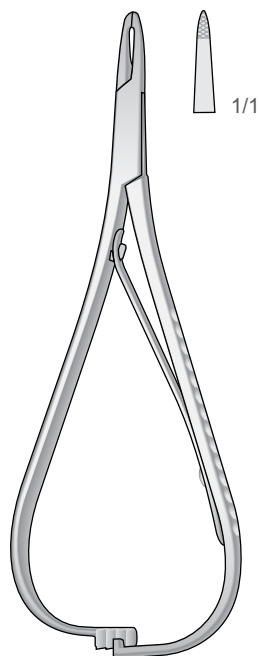
PO-40  
140 mm

NEEDLE  
HOLDERS

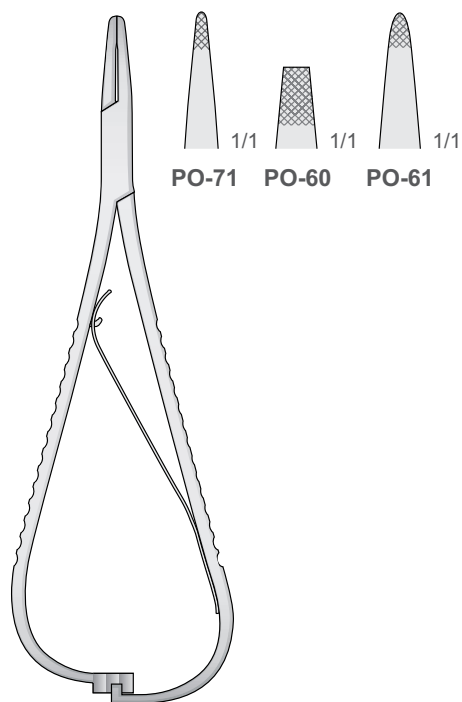




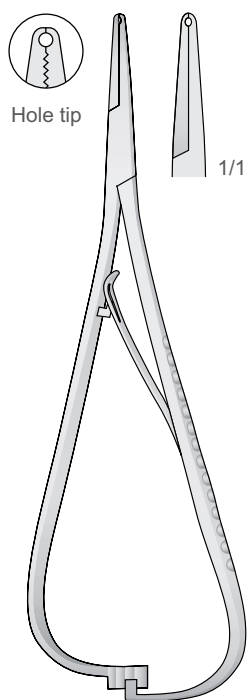
Nadelhalter  
 Needle Holders  
 Port'aghi  
 Portaagujas  
 Porte aiguilles



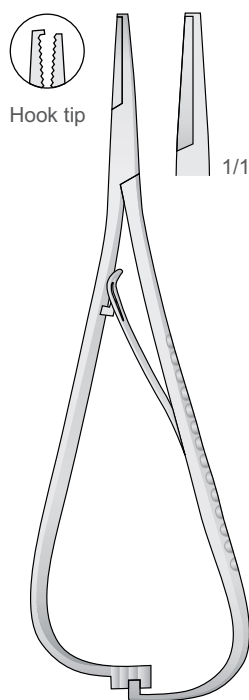
MATHIEU  
**PO-45**  
 125 mm



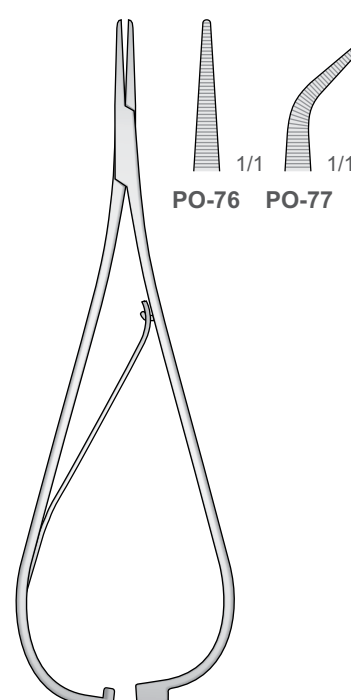
MATHIEU  
**PO-60/PO-71**  
 140 mm



SMAHA  
**PO-68**  
 140 mm



SMAHA  
**PO-69**  
 140 mm



SMAHA  
**PO-76/PO-77**  
 140 mm

NEEDLE  
 HOLDERS



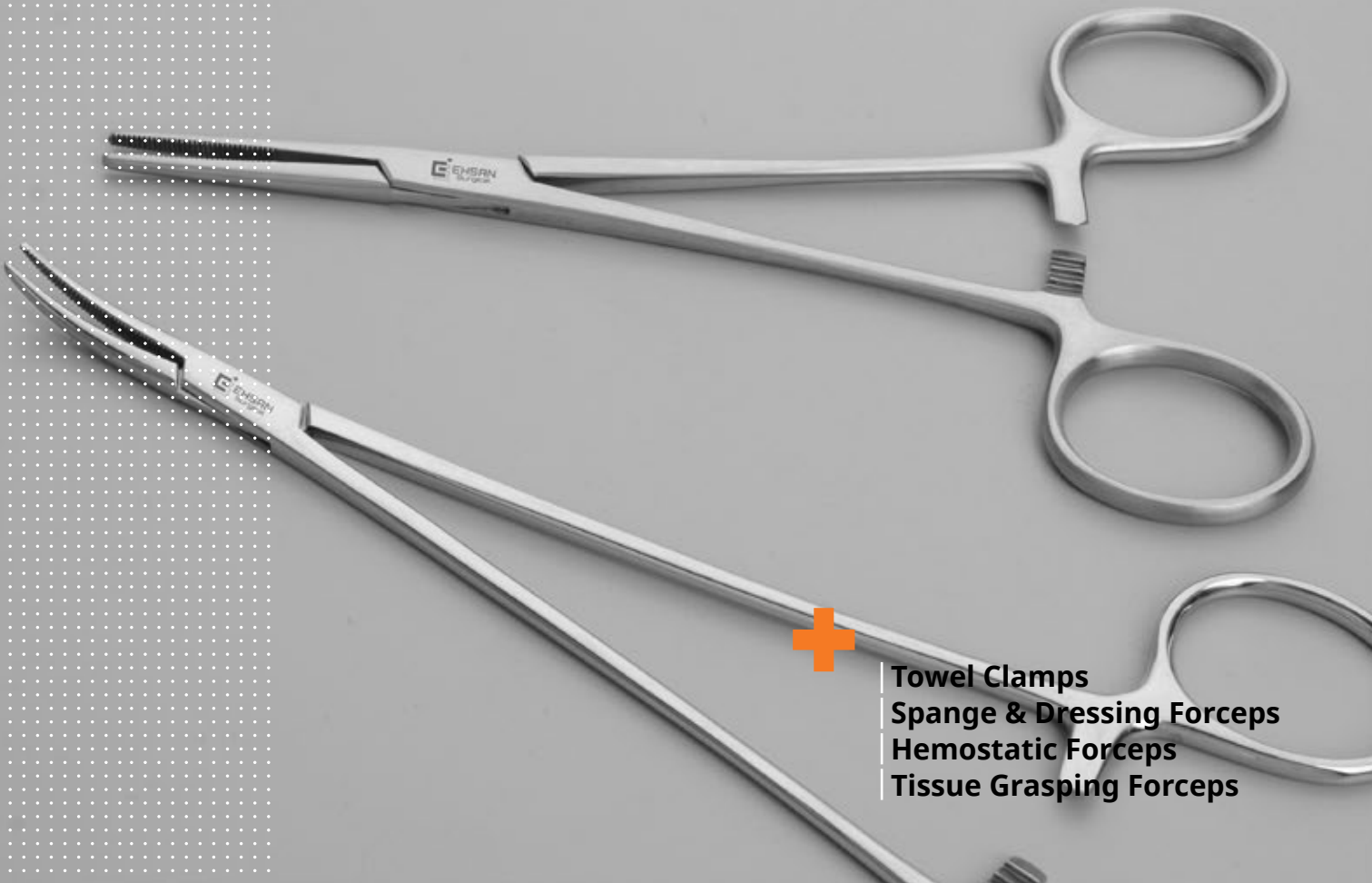




we take a closer look

# +

## HEMOSTATS / GRASPING FORCEPS



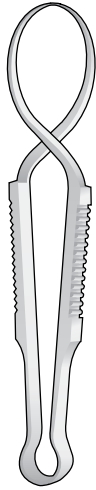
+

- Towel Clamps
- Sponge & Dressing Forceps
- Hemostatic Forceps
- Tissue Grasping Forceps

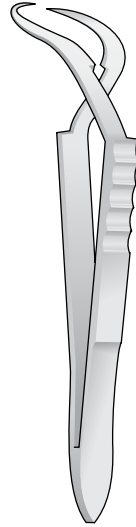
HEMOSTATS  
GRASPING



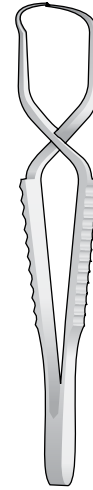
Tuchklemmen  
Towel Clamps  
Fissateli  
Pinzas de campo  
Pincas fixe-compresses



SCHAEDEL  
**BF-38**  
85 mm

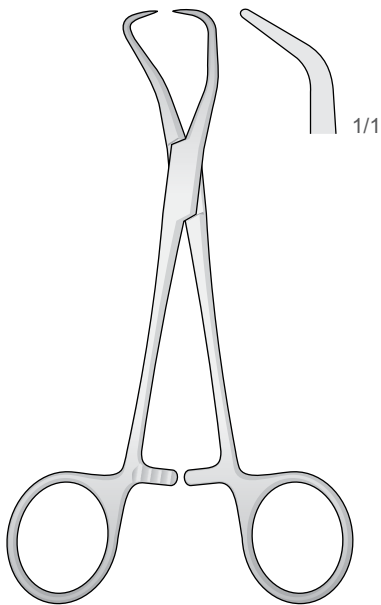


JONES  
**BF-48**  
90 mm

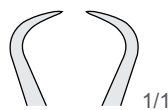


FAURE  
**BF-40**  
85 mm

HEMOSTATS  
GRASPING



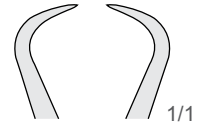
BACKHAUS  
**BF-42/BF-46**



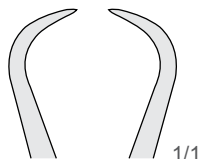
**BF-42**  
90 mm



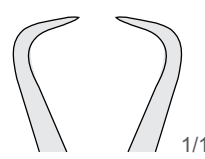
**BF-41**  
100 mm



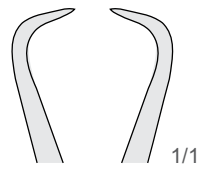
**BF-44**  
110 mm



**BF-46**  
130 mm



**BF-43**  
135 mm

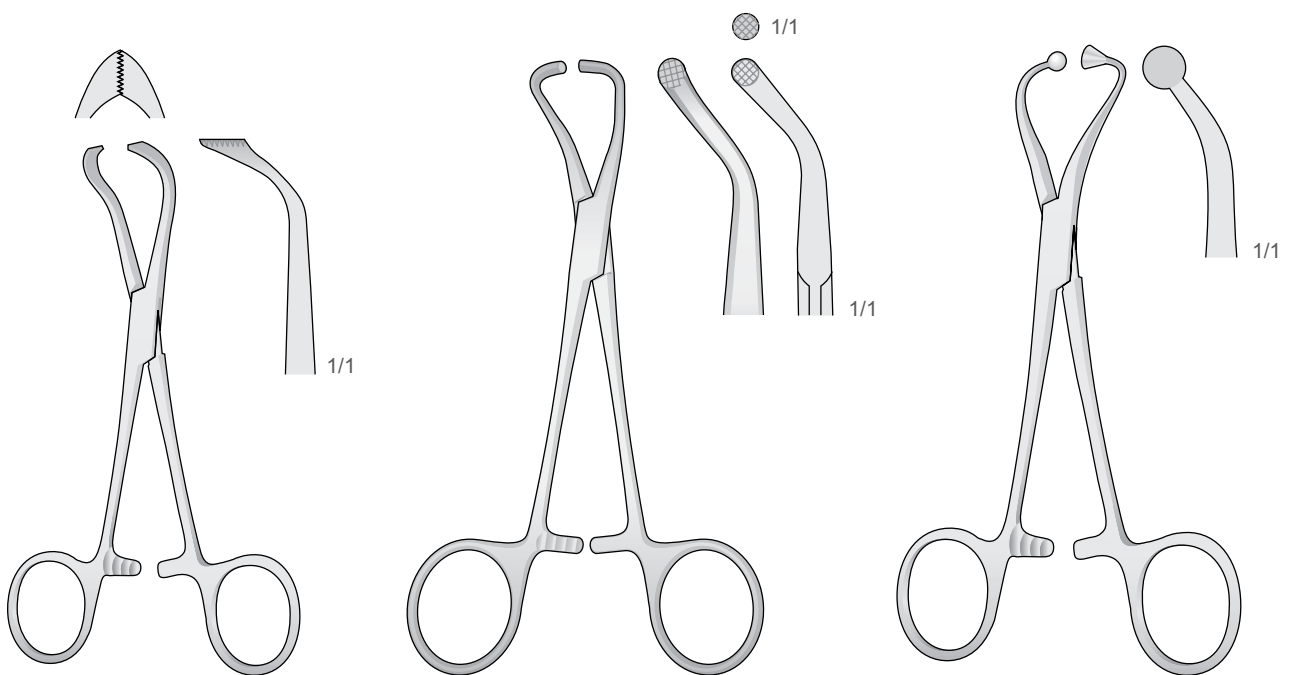


**BF-45**  
140 mm

Tuchklemmen  
Towel Clamps  
Fissateli  
Pinzas de campo  
Pincas fixe-compresses

HEMOSTATS  
GRASPING

Für Papiertücher  
For paper cloths  
Per teli di carta  
Para paños  
Pour papier



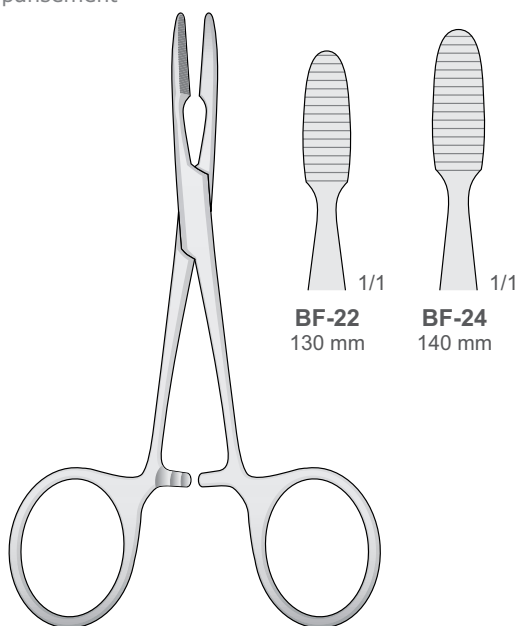
LORNA  
BF-50  
100 mm

BF-52  
130 mm

BF-75  
140 mm



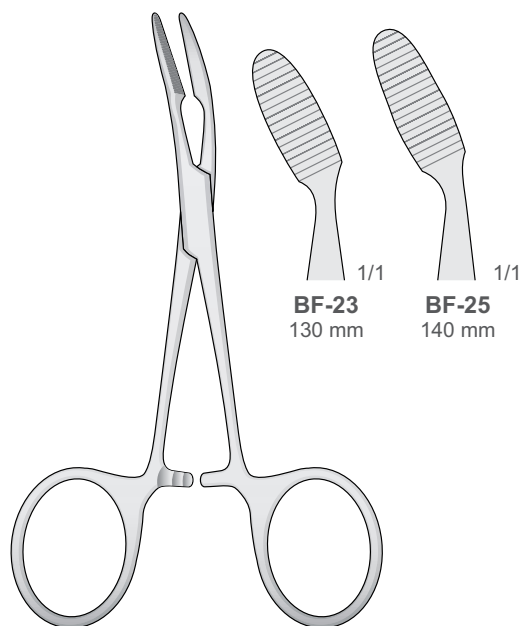
Schwamm und Tamponzangen  
 Sponge and Dressing Forceps  
 Pinze per tamponi e sponge  
 Pinzas para esponja y tampones  
 Pincas pour éponges et à pansement



**BF-22**  
130 mm

**BF-24**  
140 mm

PEAN-MURPHY  
BF-22/BF-24



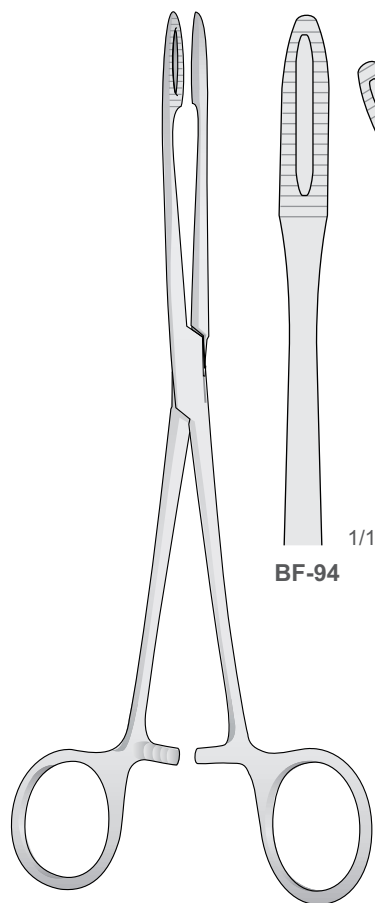
**BF-23**  
130 mm

**BF-25**  
140 mm

PEAN-MURPHY  
BF-23/BF-25

**HEMOSTATS  
GRASPING**

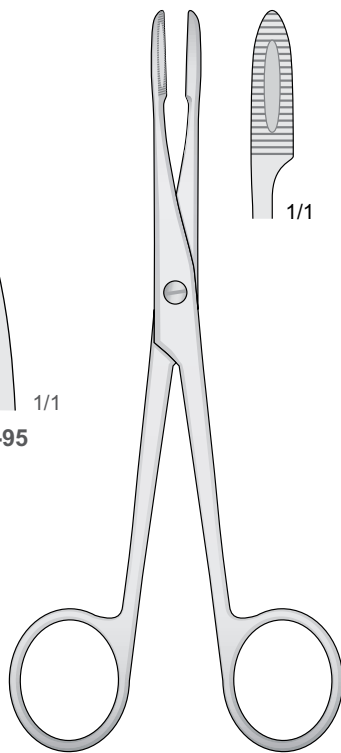
Sinus klemmen  
 Sinus forceps  
 Pinze Sinus  
 Pinzas para seno  
 Pincas à Sinus



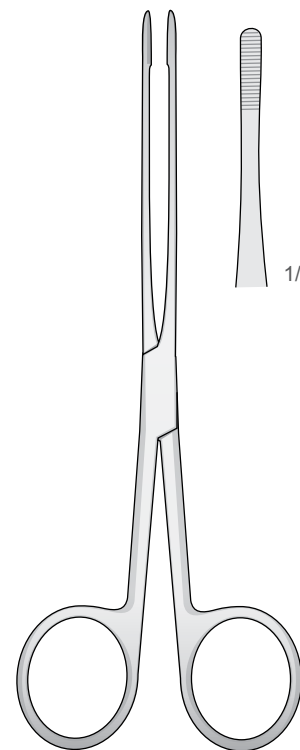
**BF-94**

**BF-95**

GROSS  
BF-94/BF-95  
200 mm

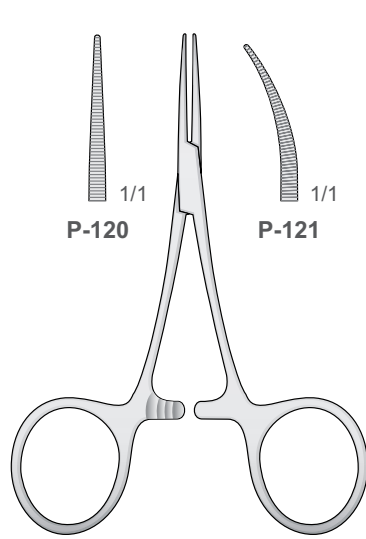


GROSS  
BF-10 130 mm  
BF-12 160 mm

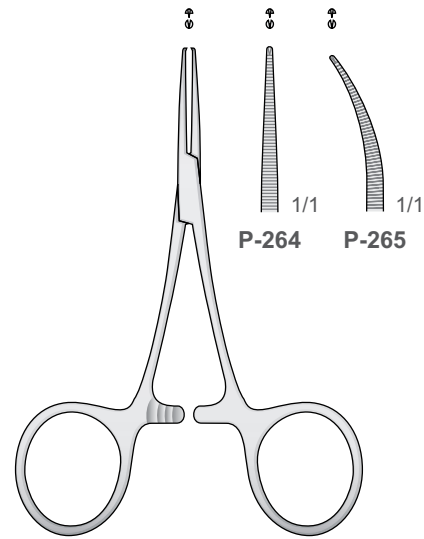


LISTER  
BF-20  
150 mm

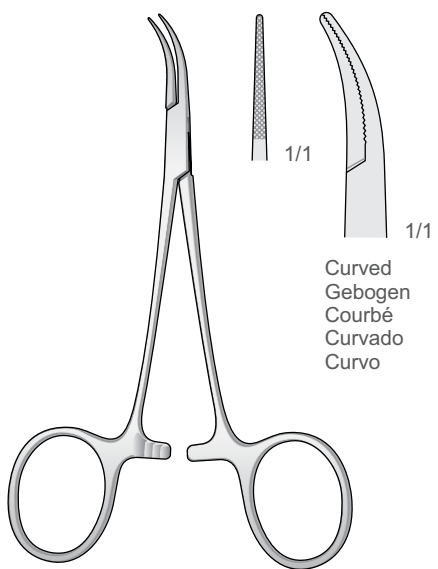




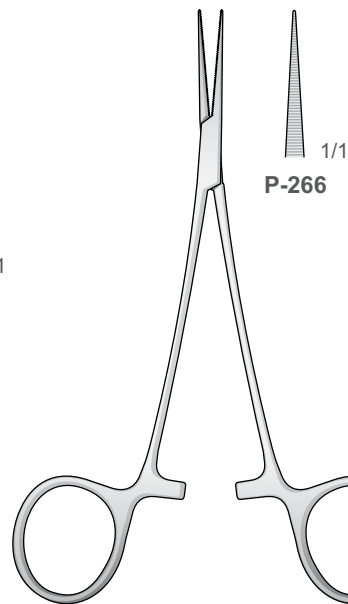
HARTMANN/BABY-MOSQUITO  
**P-120/P-121**  
 95 mm



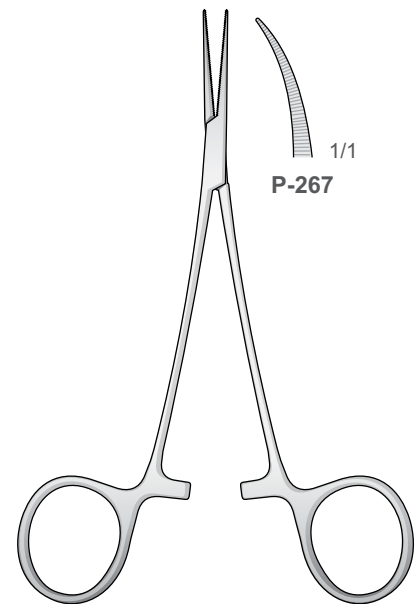
HARTMANN/BABY-MOSQUITO  
**P-264/P-265**  
 95 mm



DANDY-MOSQUITO  
**P-332**  
 120 mm



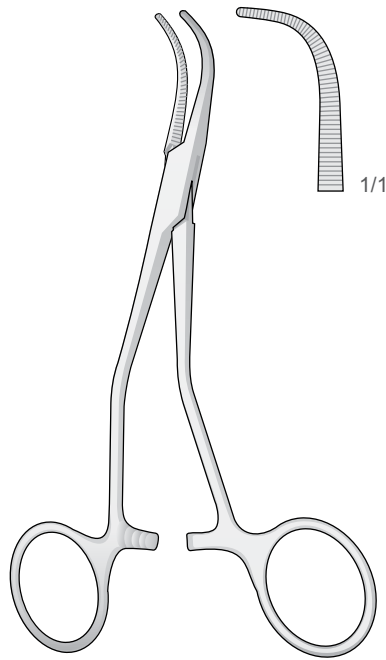
JACOBSON-MICRO  
**P-266**  
 130 mm



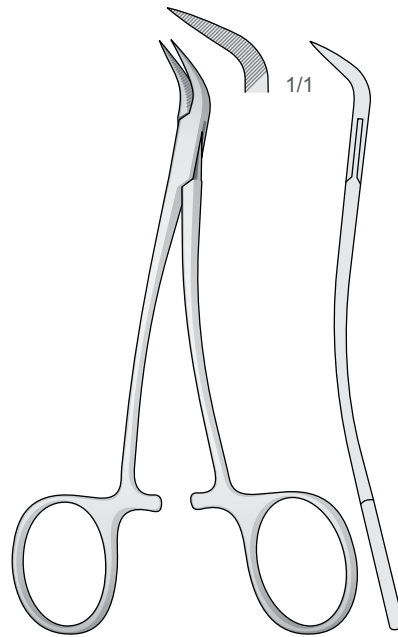
JACOBSON-MICRO  
**P-267**  
 130 mm



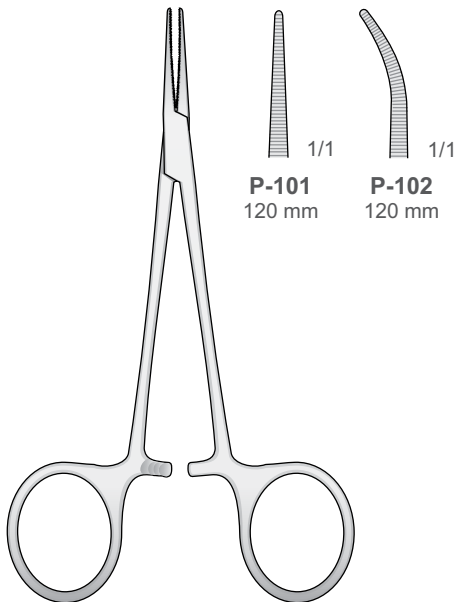
Arterienklemmen  
 Hemostatic Forceps  
 Pinze emostatiche  
 Pinzas hemostáticas  
 Pinces hémostatiques



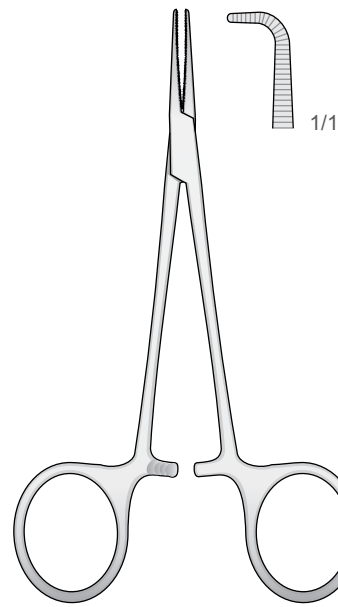
**P-15**  
 130 mm



**PEET  
 DR-40**  
 120 mm



**MICRO-HALSTED  
 P-101/P-102**



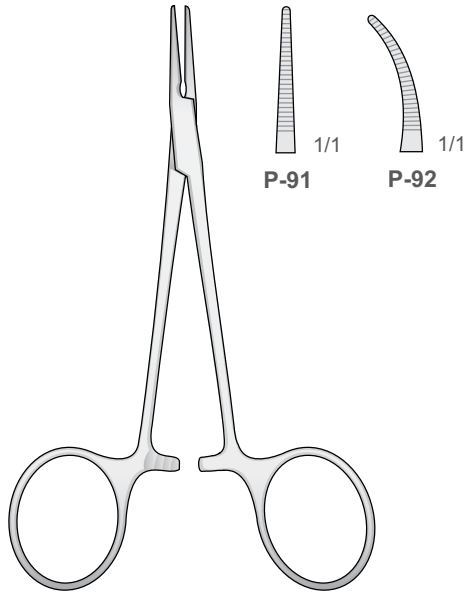
**MICRO-HALSTED  
 P-135**  
 115 mm

**HEMOSTATS  
 GRASPING**

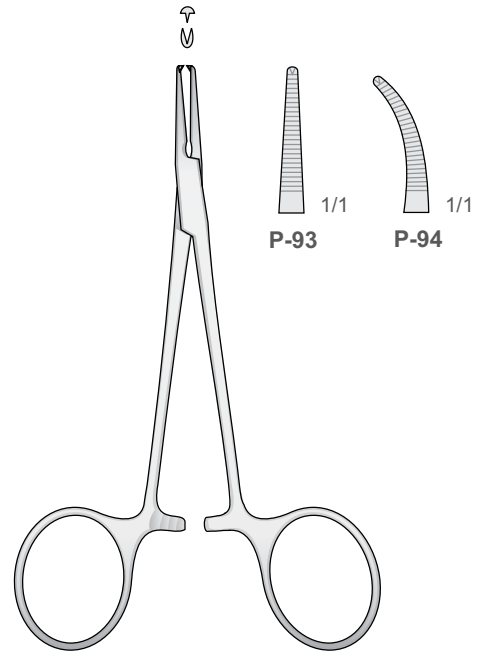


Arterienklemmen  
 Hemostatic Forceps  
 Pinze emostatiche  
 Pinzas hemostáticas  
 Pinces hémostatiques

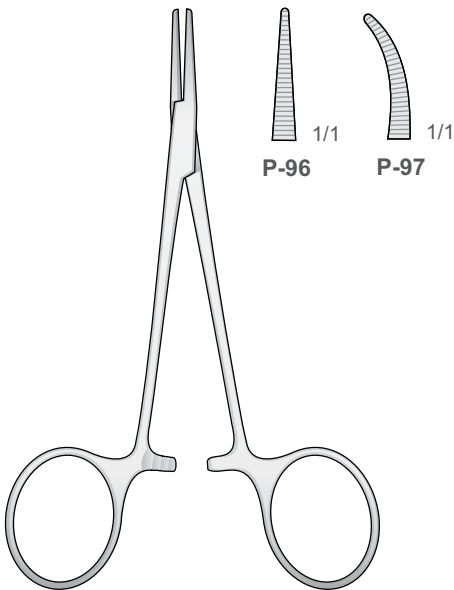
HEMOSTATS  
 GRASPING



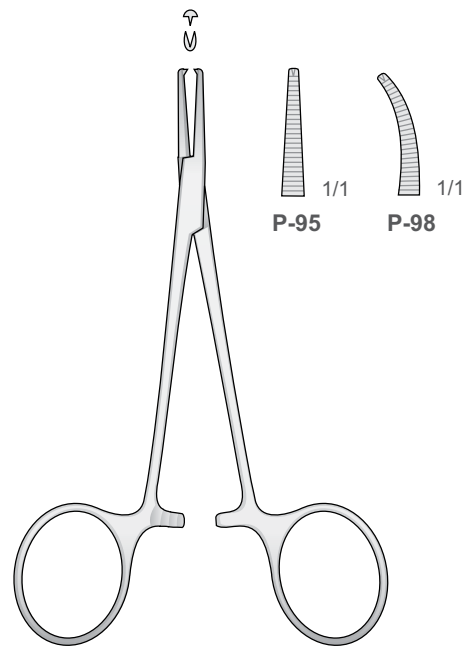
HALSTED  
**P-91/P-92**  
 125 mm



HALSTED  
**P-93/P-94**  
 125 mm



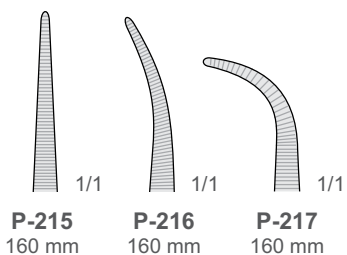
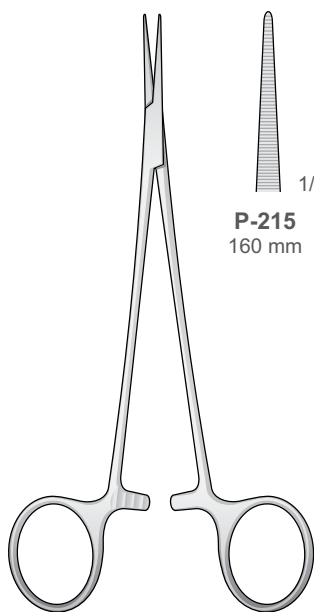
HALSTED-MOSQUITO  
**P-96/P-97**  
 120 mm



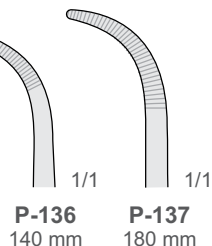
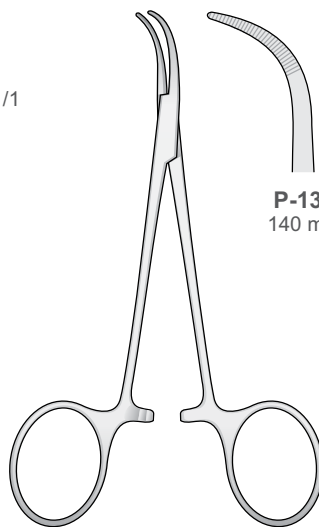
HALSTED-MOSQUITO  
**P-95/P-98**  
 120 mm



Arterienklemmen  
 Hemostatic Forceps  
 Pinze emostatiche  
 Pinzas hemostáticas  
 Pincés hémostatiques

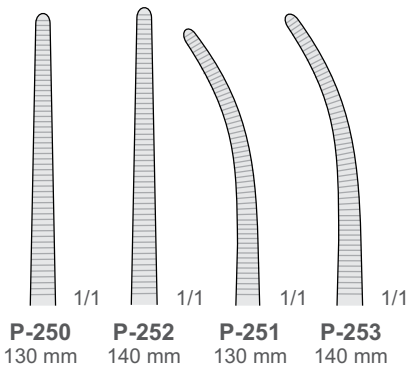
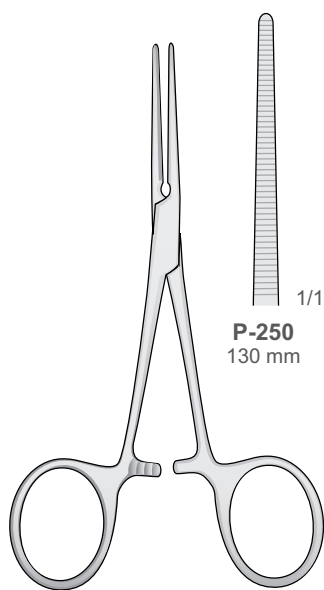


**P-215/P-217**  
160 mm

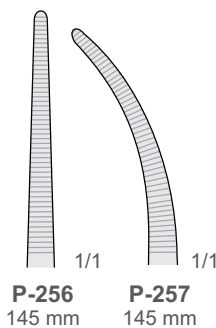
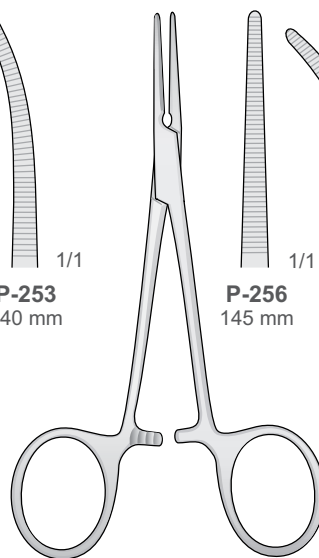


**BABY-MIXTER**  
**P-136/P-137**

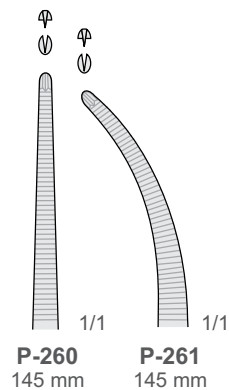
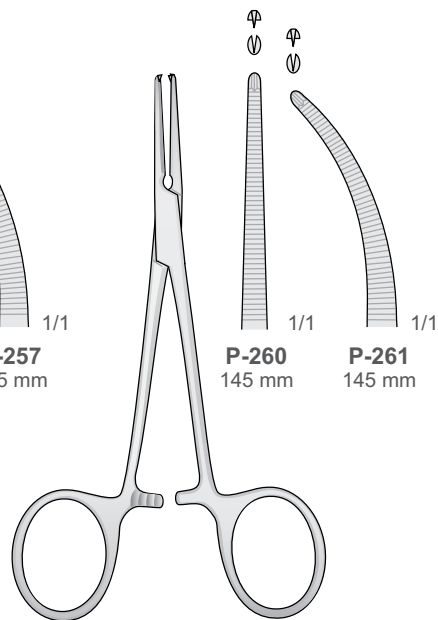
HEMOSTATS  
GRASPING



**PEAN**  
**P-250/P-253**



**PEAN**  
**P-256/P-257**

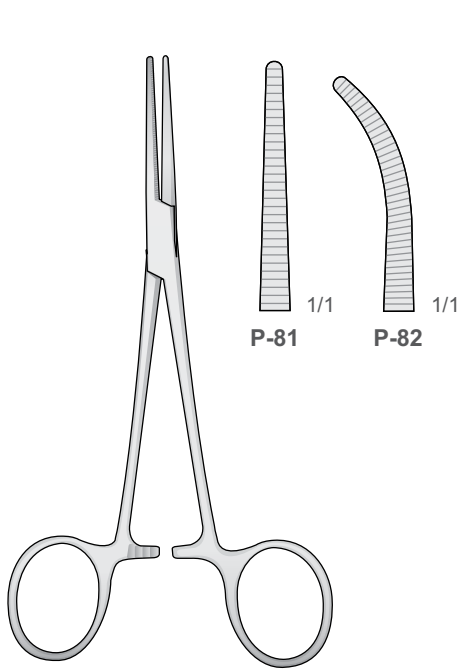


**KOCHER**  
**P-260/P-261**

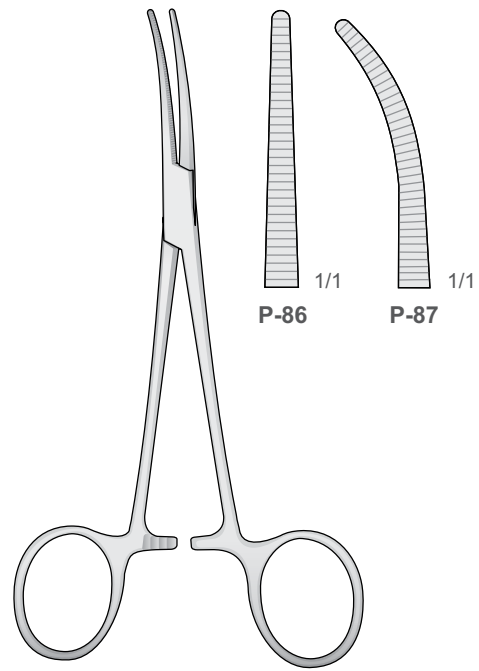


Arterienklemmen  
 Hemostatic Forceps  
 Pinze emostatiche  
 Pinzas hemostáticas  
 Pinces hémostatiques

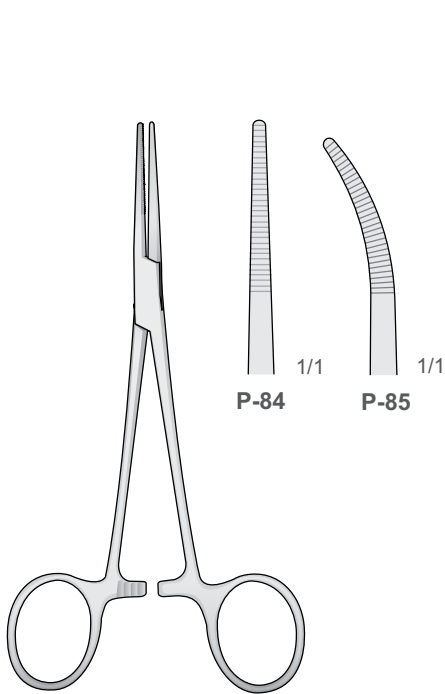
HEMOSTATS  
 GRASPING



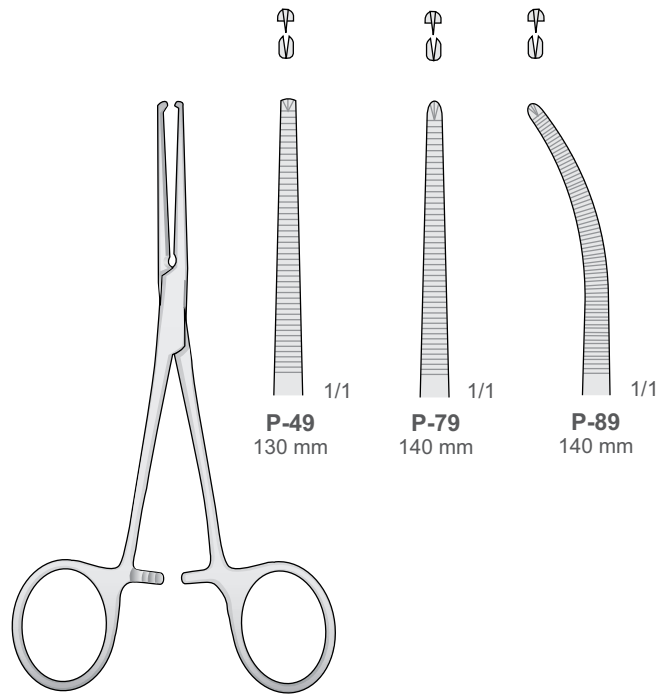
CRILE  
**P-81/P-82**  
 140 mm



CRILE  
**P-86/P-87**  
 160 mm



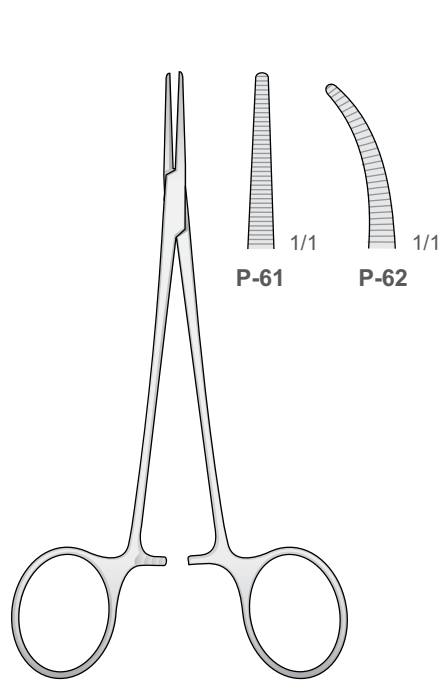
KELLY  
**P-84/P-85**  
 140 mm



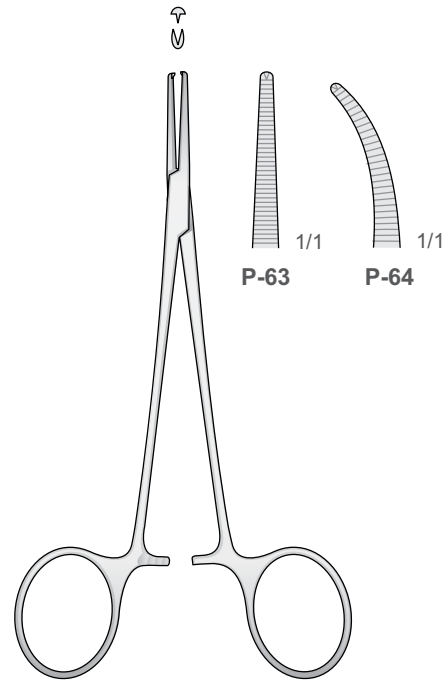
KOCHER  
**P-49/P-89**



Arterienklemmen  
 Hemostatic Forceps  
 Pinze emostatiche  
 Pinzas hemostáticas  
 Pincas hémostatiques

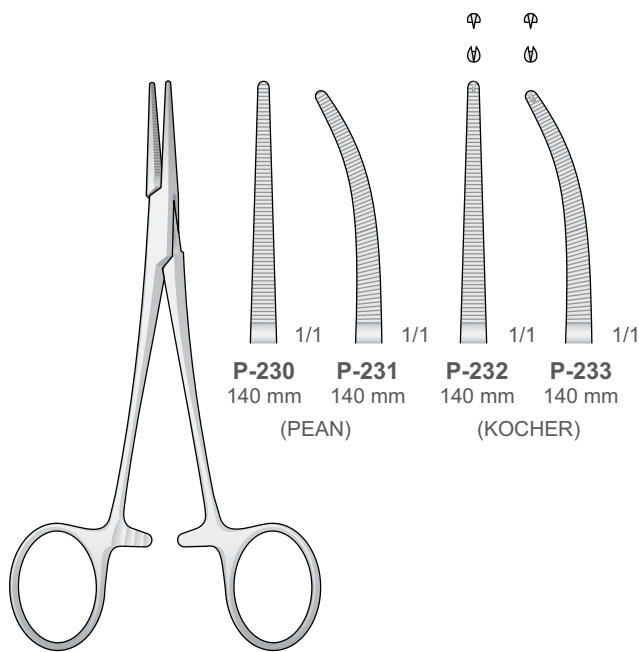


LERICHE  
**P-61/P-62**  
 150 mm

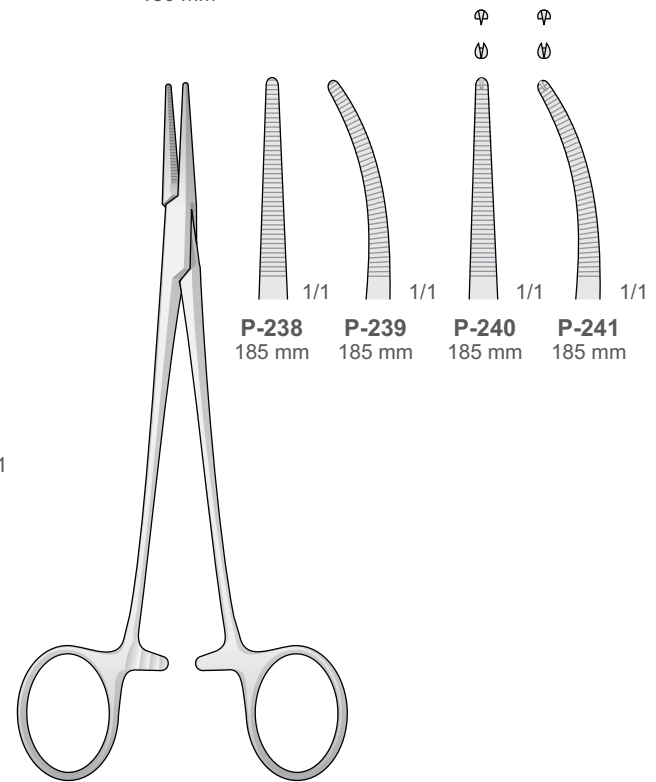


LERICHE  
**P-63/P-64**  
 150 mm

HEMOSTATS  
 GRASPING



BABY-CRILE  
**P-230/P-233**  
 140 mm

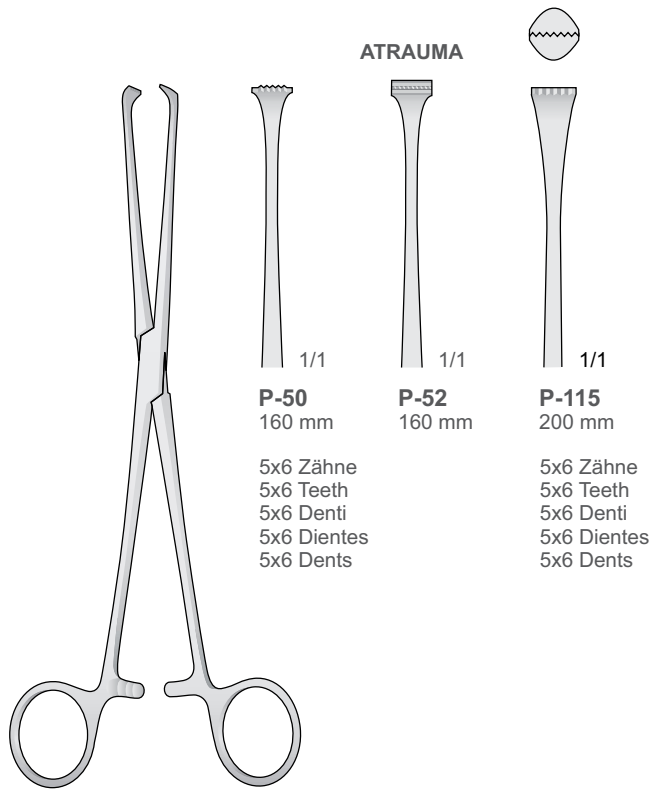


HALSTED  
**P-238/P-241**  
 185 mm



Gewebefasszangen  
Tissue Grasping Forceps  
Pinze per tessuti  
Pinzas para tejidos  
Pincers pour tissus

**ATRAUMA**



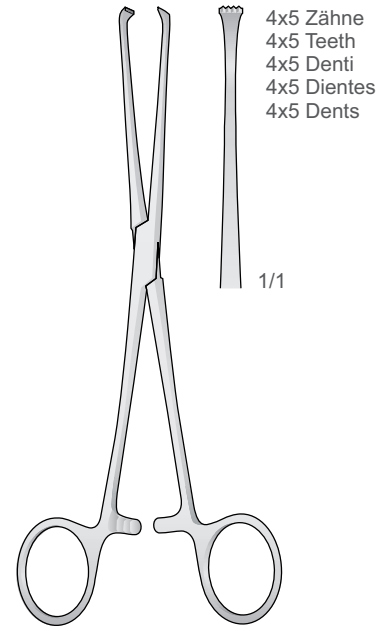
**P-50**  
160 mm

5x6 Zähne  
5x6 Teeth  
5x6 Denti  
5x6 Dientes  
5x6 Dents

**P-52**  
160 mm

**P-115**  
200 mm

5x6 Zähne  
5x6 Teeth  
5x6 Denti  
5x6 Dientes  
5x6 Dents

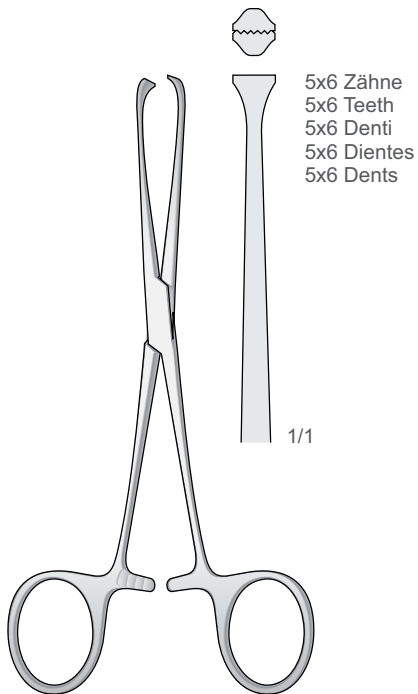


4x5 Zähne  
4x5 Teeth  
4x5 Denti  
4x5 Dientes  
4x5 Dents

**BABY-ALLIS**  
**P-100**  
130 mm

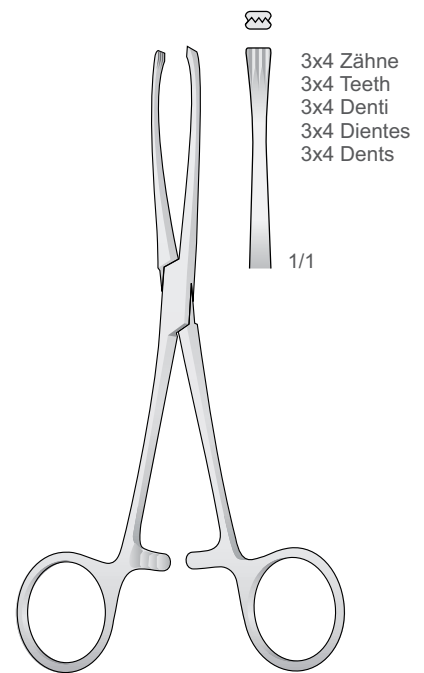
**HEMOSTATS  
GRASPING**

**ALLIS**  
**P-50/P-52**



5x6 Zähne  
5x6 Teeth  
5x6 Denti  
5x6 Dientes  
5x6 Dents

**BOYS-ALLIS**  
**P-129**  
150 mm



3x4 Zähne  
3x4 Teeth  
3x4 Denti  
3x4 Dientes  
3x4 Dents

**JUDD-ALLIS**  
**P-324**  
155 mm





we take a closer look

# + RETRACTORS

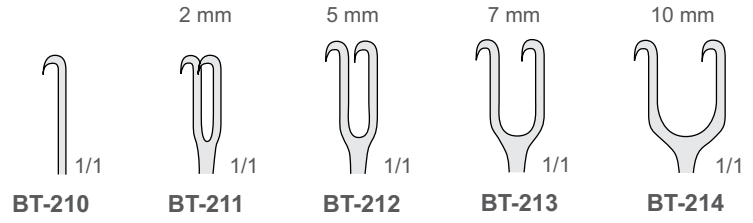
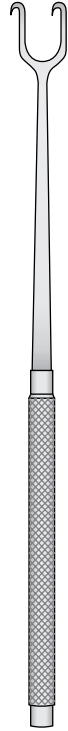
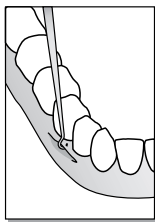


Retractors  
Mouth Gags & Tongue  
Depressors  
Mouth Praps

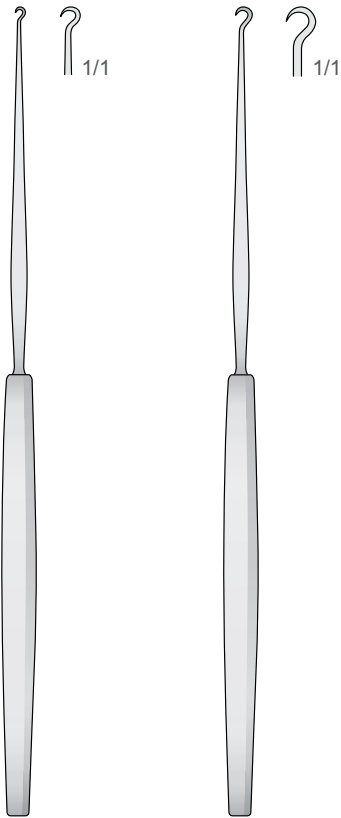




Wundhaken  
Retractors  
Divaricatori  
Separadores  
Écarteurs



JOSEPH  
BT-210/BT-214  
160 mm

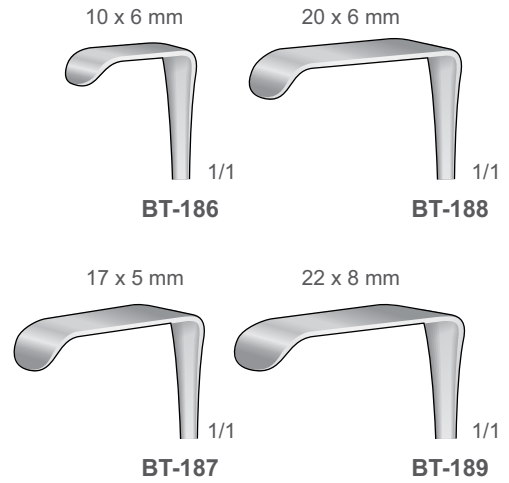


GILLIES  
BT-15  
180 mm

GILLIES  
BT-16  
180 mm



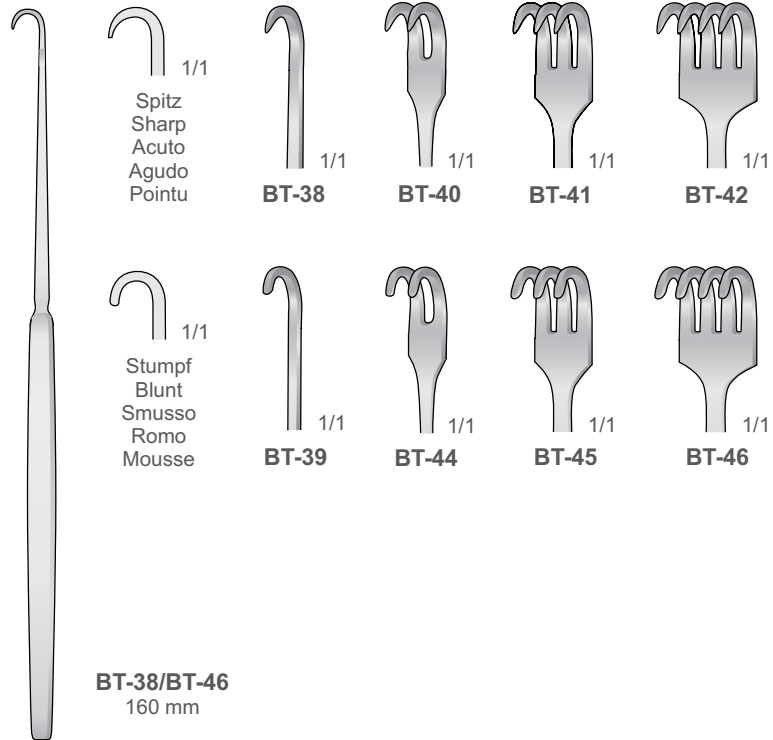
MINI-LANGENBECK  
BT-186/BT-189  
160 mm



RETRACTORS



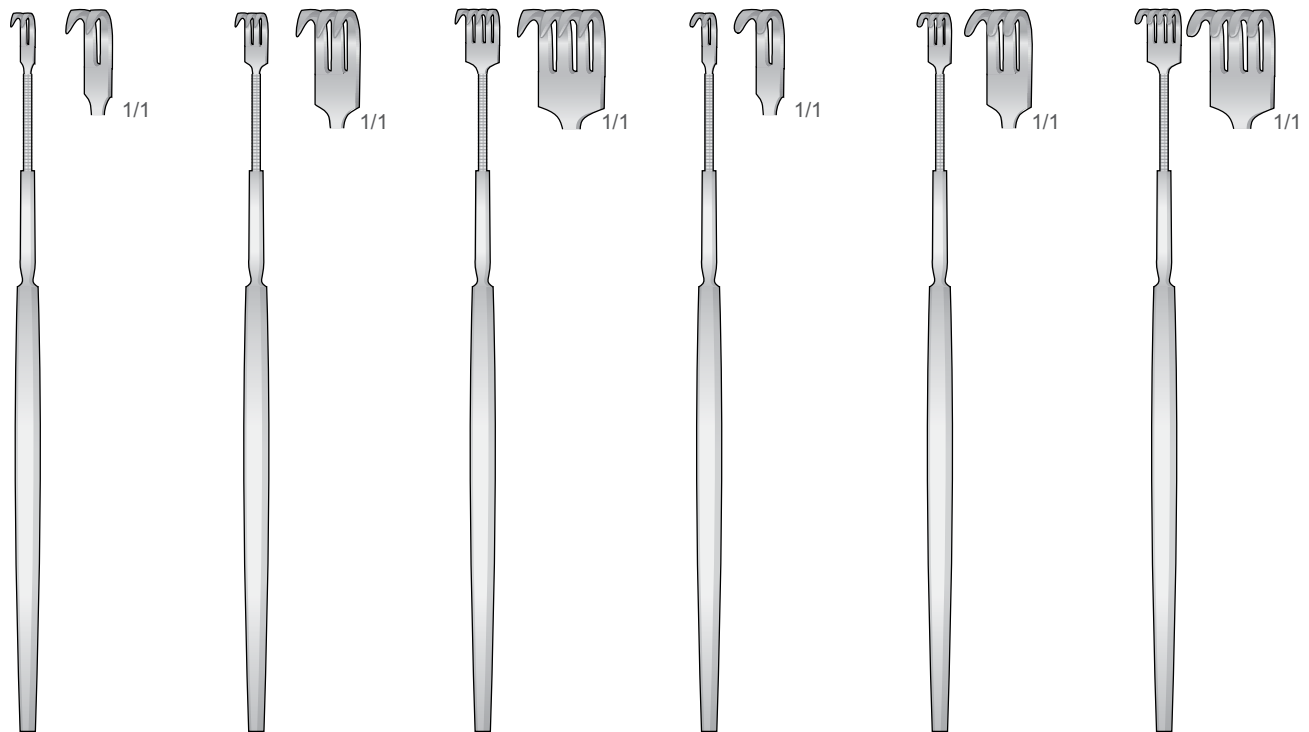
Wundhaken  
Retractors  
Divaricatori  
Separadores  
Écarteurs



Feine wundhaken flexibel-spitz  
Delicate retractors flexible-sharp  
Divaricatori delicati flessibili-acuti  
Separadores finos flexibles-agudos  
Écarteurs fins pointu flexible

Feine wundhaken flexibel-stumpf  
Delicate retractors flexible-blunt  
Divaricatori delicati flessibili-smussi  
Separadores finos flexibles-romos  
Écarteurs fins mousse flexible

RETRACTORS



BT-50  
150 mm

BT-51  
150 mm

BT-52  
150 mm

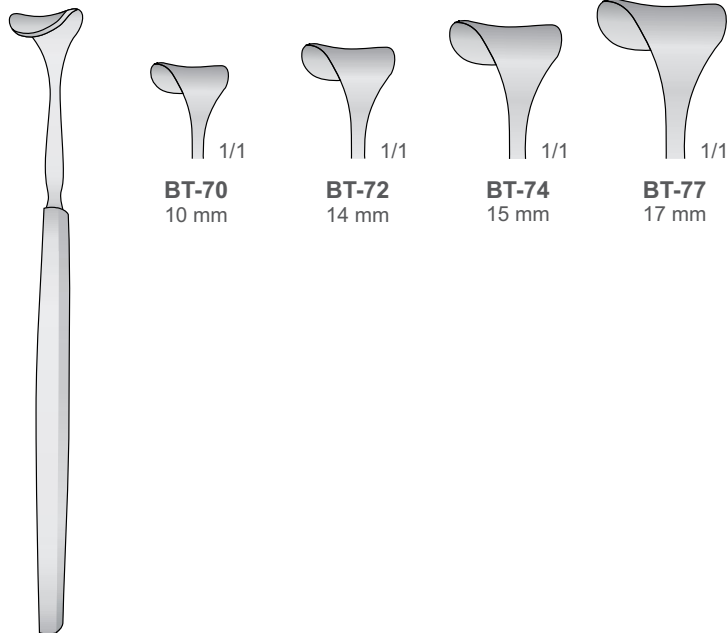
BT-54  
150 mm

BT-55  
150 mm

BT-56  
150 mm



Wundhaken  
 Retractors  
 Divaricatori  
 Separadores  
 Écarteurs



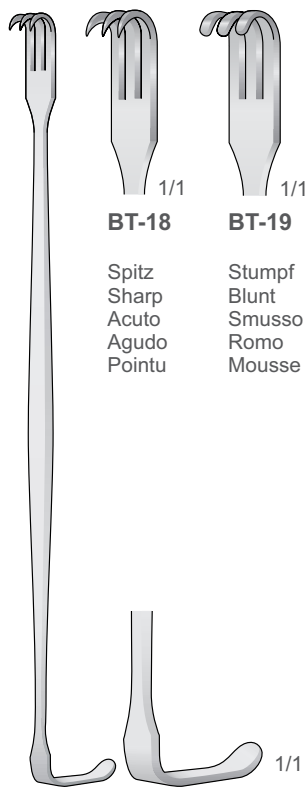
**BT-70**  
10 mm

**BT-72**  
14 mm

**BT-74**  
15 mm

**BT-77**  
17 mm

DESMARRES  
**BT-70/BT-77**  
140 mm



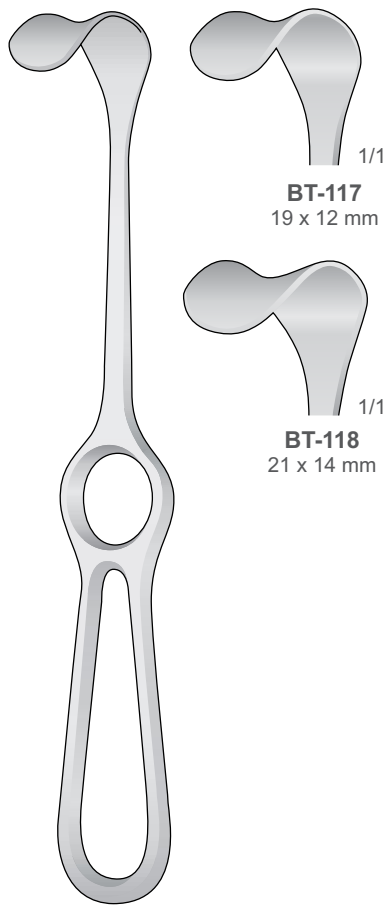
**BT-18**

**BT-19**

Spitz  
 Sharp  
 Acuto  
 Agudo  
 Pointu

Stumpf  
 Blunt  
 Smusso  
 Romo  
 Mousse

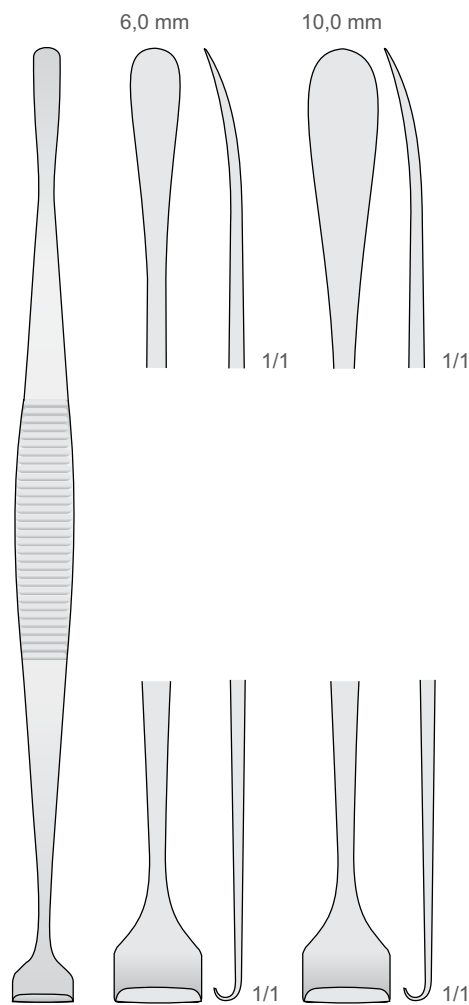
SEAN-MILLER  
**BT-18/BT-19**  
160 mm



**BT-117**  
19 x 12 mm

**BT-118**  
21 x 14 mm

KOCHER  
**BT-117/BT-118**  
205 mm



6,0 mm

10,0 mm

12 mm

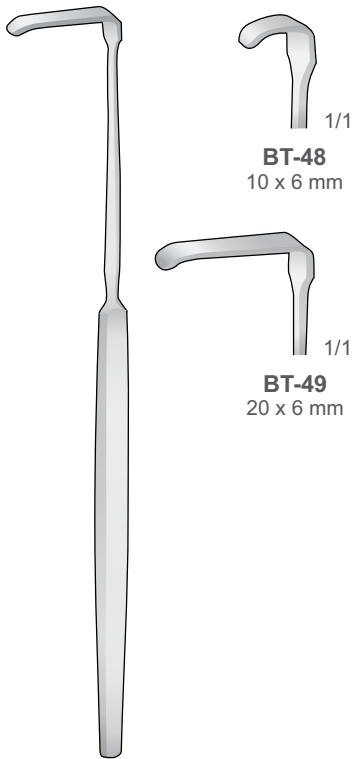
12 mm

HURD  
**BT-1/BT-2**  
220 mm

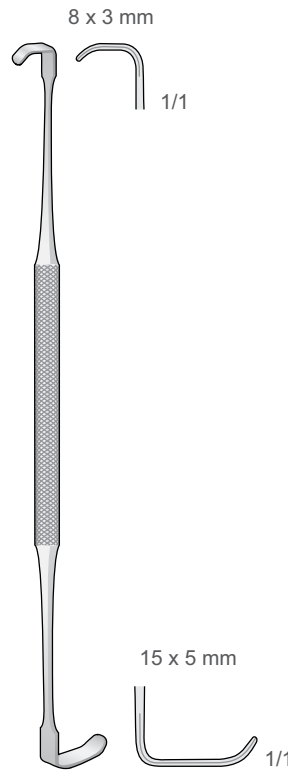
RETRACTORS



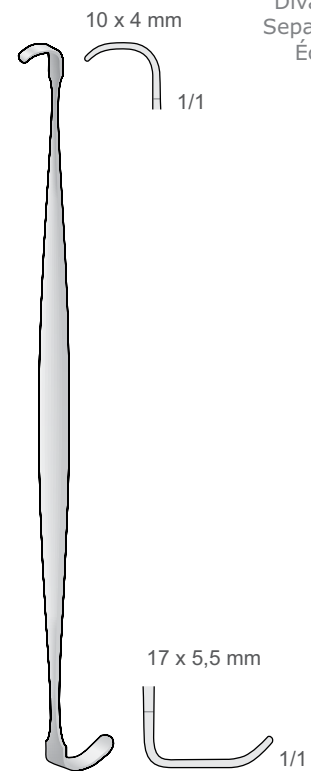
Wundhaken  
Retractors  
Divaricatori  
Separadores  
Écarteurs



SENN GREEN  
**BT-48/BT-49**  
160 mm

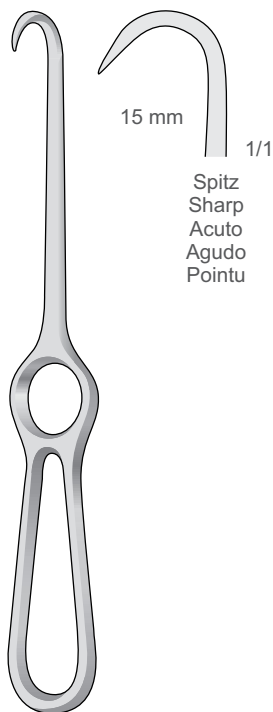


RAGNELL  
**BT-27**  
140 mm

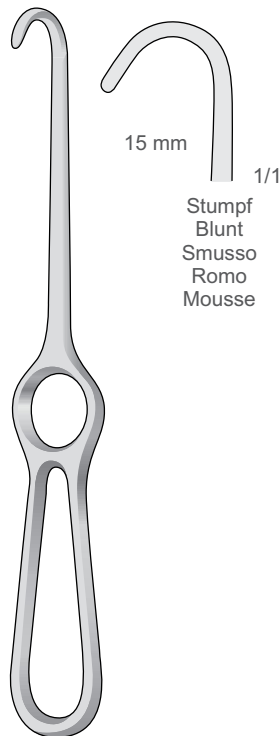


RAGNELL-DAVIS  
**BT-26**  
140 mm

RETRACTORS



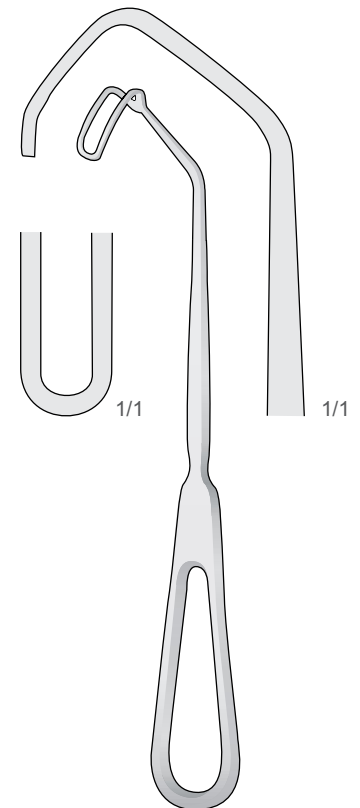
KOCHER  
**BT-139**  
205 mm



KOCHER  
**BT-140**  
220 mm



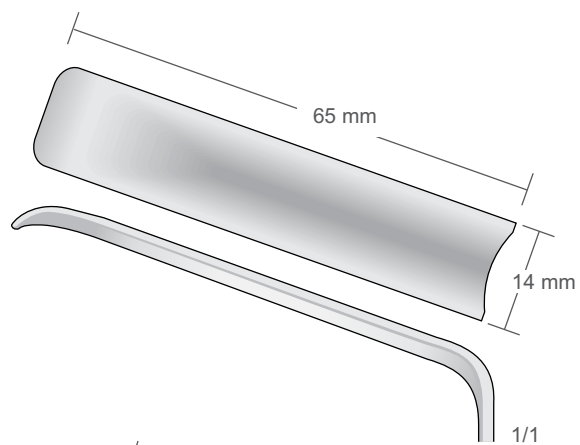
LAHEY  
**BT-109**  
195 mm



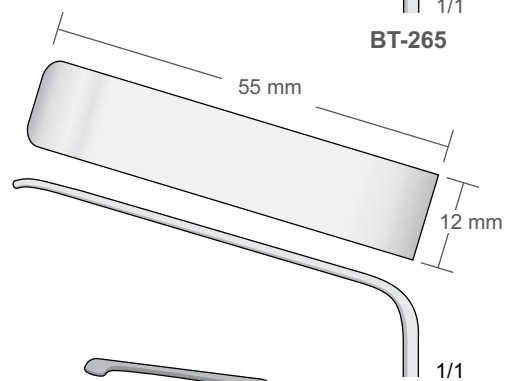
CUSHING  
**BT-29**  
200 mm



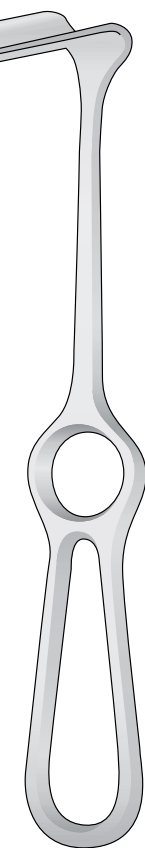
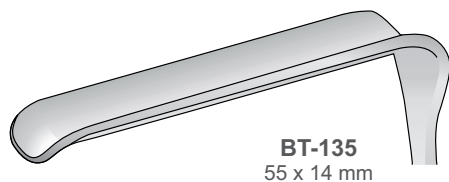
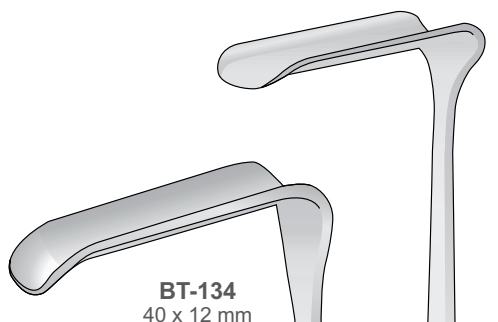
Wundhaken  
Retractors  
Divaricatori  
Separadores  
Écarteurs



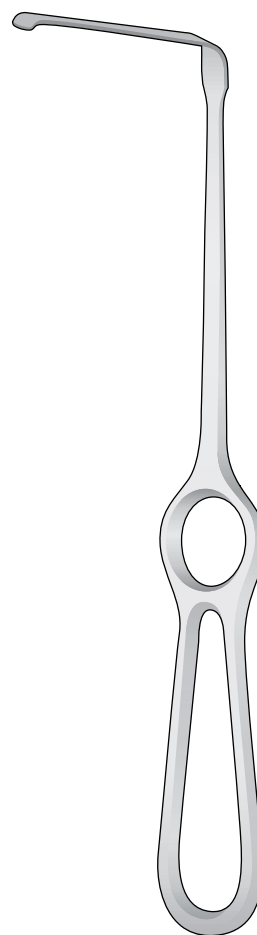
**BT-265**



**BT-264**



DOCKHORN  
**BT-134/BT-135**  
210 mm



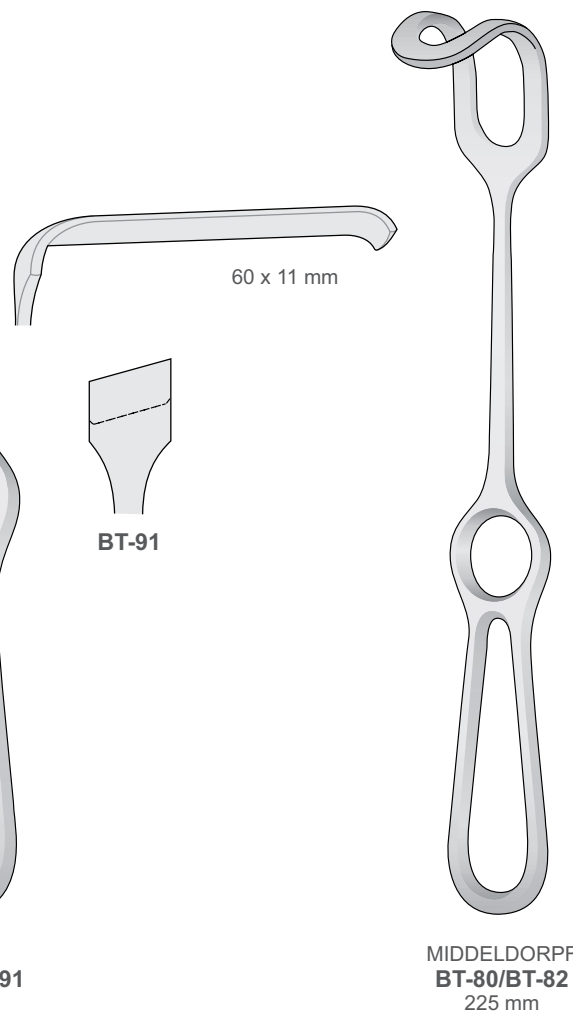
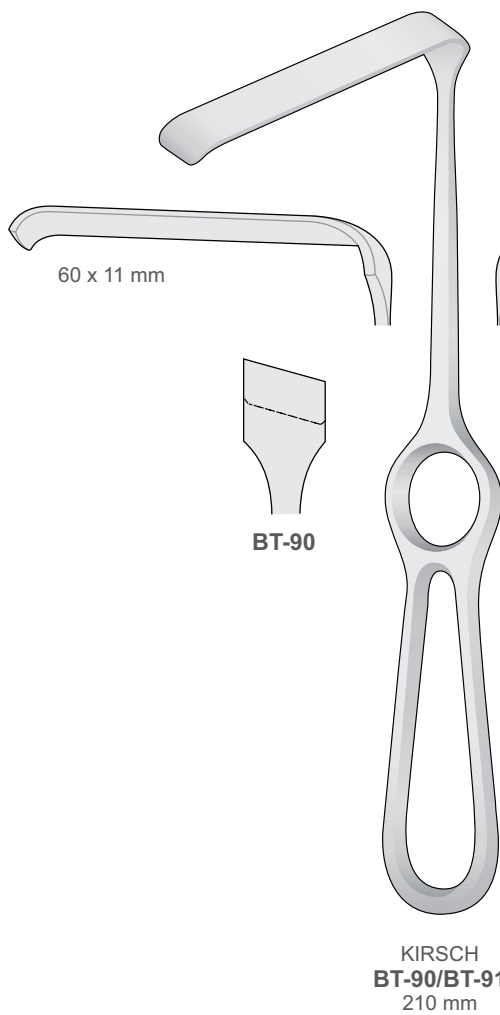
**BT-264/BT-265**  
235 mm

RETRACTORS



Wundhaken  
Retractors  
Divaricatori  
Separadores  
Écarteurs

RETRACTORS



Wundhaken  
Retractors  
Divaricatori  
Separadores  
Écarteurs



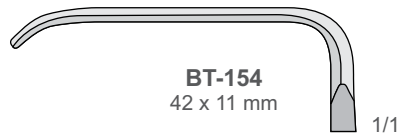
**BT-152**  
25 x 7 mm

1/1



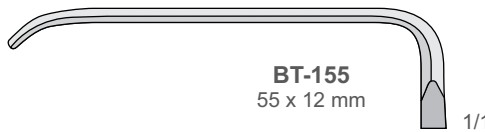
**BT-153**  
31 x 10 mm

1/1



**BT-154**  
42 x 11 mm

1/1



**BT-155**  
55 x 12 mm

1/1



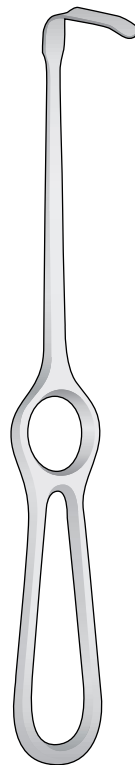
**BT-156**  
70 x 14 mm

1/1



**BT-157**  
80 x 16 mm

1/1

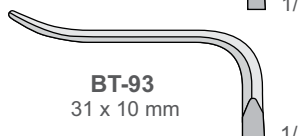


OBWEGESER  
**BT-152/BT-157**  
220 mm



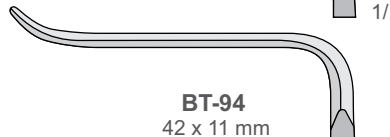
**BT-92**  
25 x 7 mm

1/1



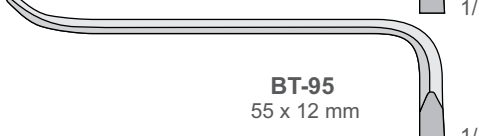
**BT-93**  
31 x 10 mm

1/1



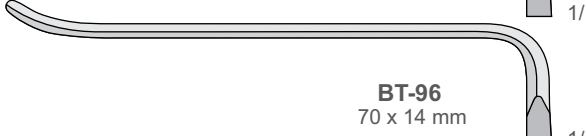
**BT-94**  
42 x 11 mm

1/1



**BT-95**  
55 x 12 mm

1/1



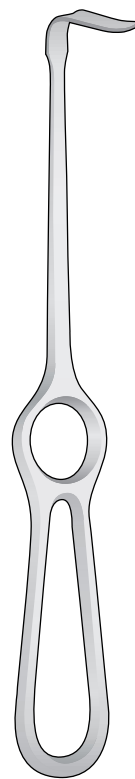
**BT-96**  
70 x 14 mm

1/1



**BT-100**  
80 x 16 mm

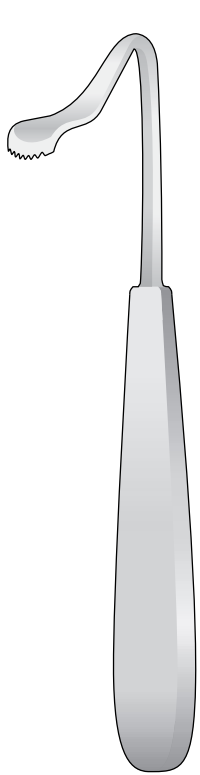
1/1



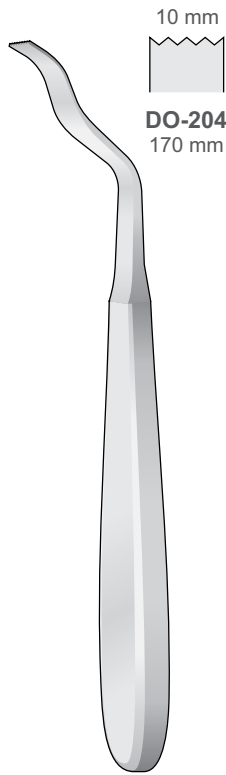
OBWEGESER  
**BT-92/BT-100**  
220 mm

RETRACTORS

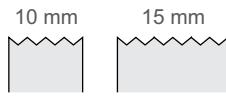




**BOWLED-HENRY**  
**DO-175**  
170 mm



**DO-204/DO-204L**  
170 mm

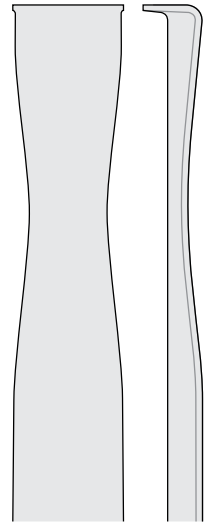


**DO-204**  
170 mm

**DO-204L**  
170 mm

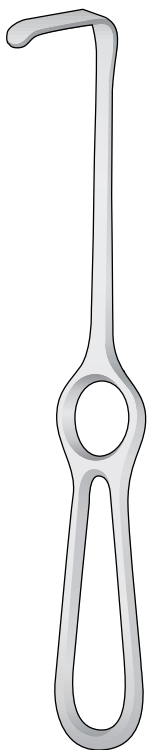


**AUSTIN**  
**DO-212**  
140 mm

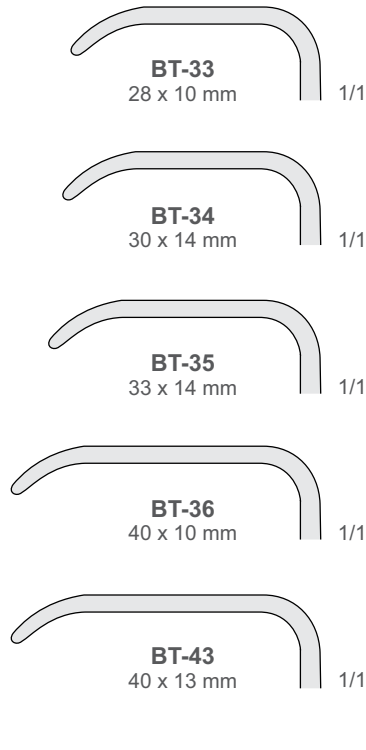


1/1

RETRACTORS



**LANGENBECK**  
**BT-33/BT-43**  
210 mm



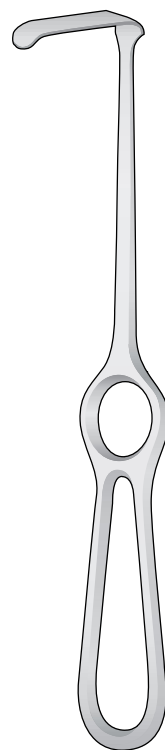
**BT-33**  
28 x 10 mm 1/1

**BT-34**  
30 x 14 mm 1/1

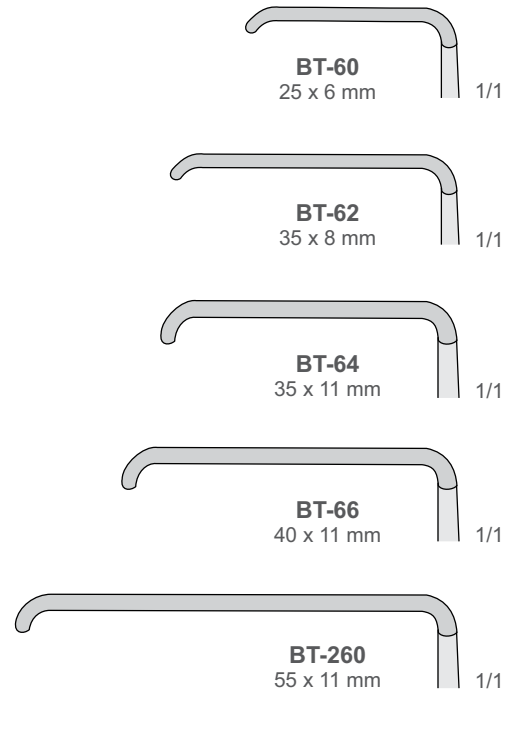
**BT-35**  
33 x 14 mm 1/1

**BT-36**  
40 x 10 mm 1/1

**BT-43**  
40 x 13 mm 1/1



**KOCHER-LANGENBECK**  
**BT-60/BT-260**  
215 mm



**BT-60**  
25 x 6 mm 1/1

**BT-62**  
35 x 8 mm 1/1

**BT-64**  
35 x 11 mm 1/1

**BT-66**  
40 x 11 mm 1/1

**BT-260**  
55 x 11 mm 1/1





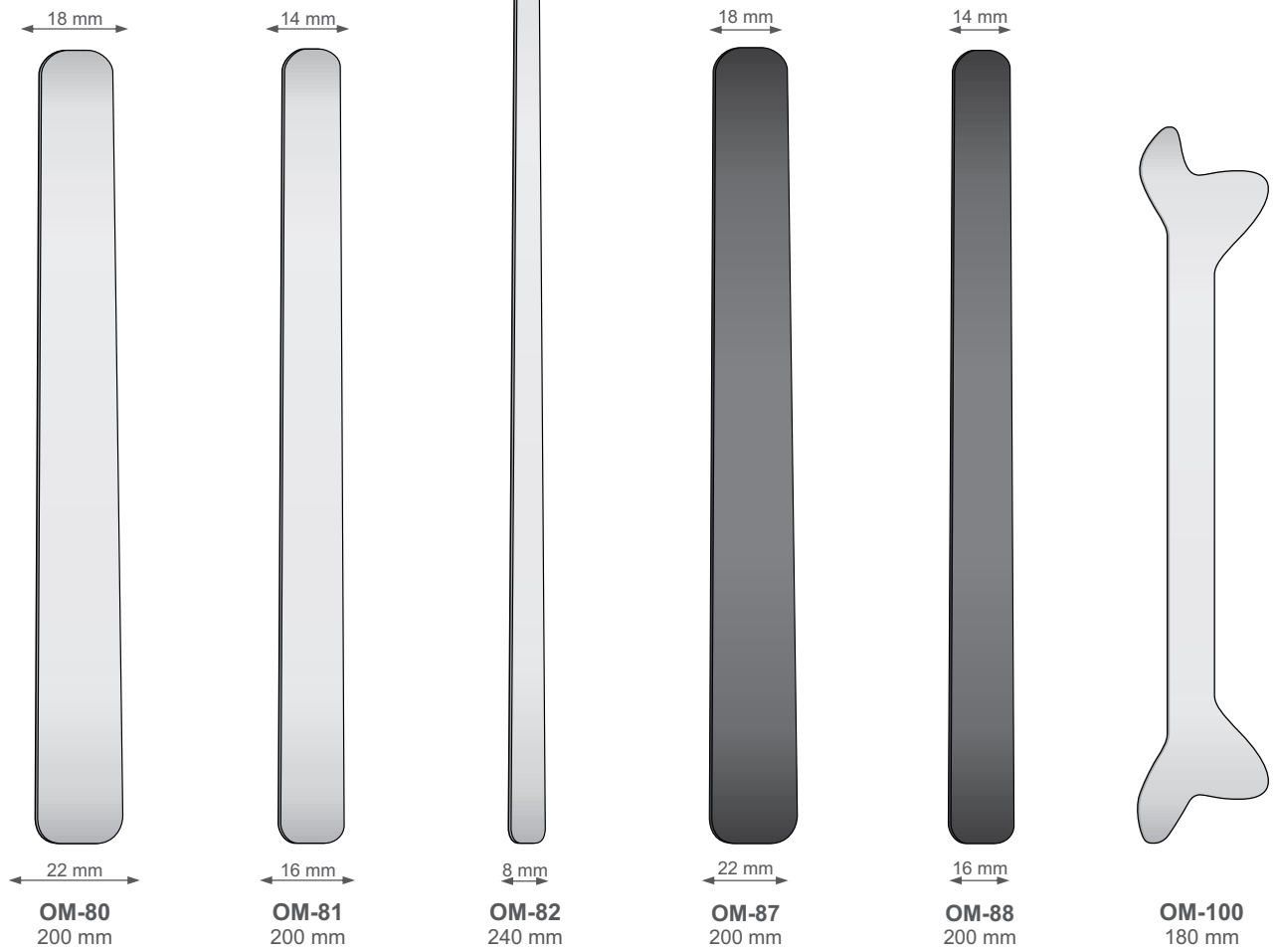
Wundhaken  
 Retractors  
 Divaricatori  
 Separadores  
 Écarteurs

Rostfrei - Stainless Steel  
 Acciaio - Acero - Acer

Biegsam - Malleable  
 Malleabili - Maleables  
 Souples

**OM-85**  
 Komplettsset mit 3 Spatel  
 Set complete with 3 spatulas  
 Set completo con 3 spatole  
 Set completos con 3 espátulas  
 Set complete avec 3 spatules  
**OM-80 + OM-81 + OM-82**

Schwarz Verchromt  
 Black anodized  
 Cromato nero  
 Cromado en negro  
 Chromé noir



RETRACTORS



Zungendrucker  
 Tongue Depressors  
 Abbassalingua  
 Bajalengua  
 Abaisse langue

Kinnhalter  
 Chin Holder  
 Divaricatore per mento  
 Separador para mentón  
 Écarteur pour menton

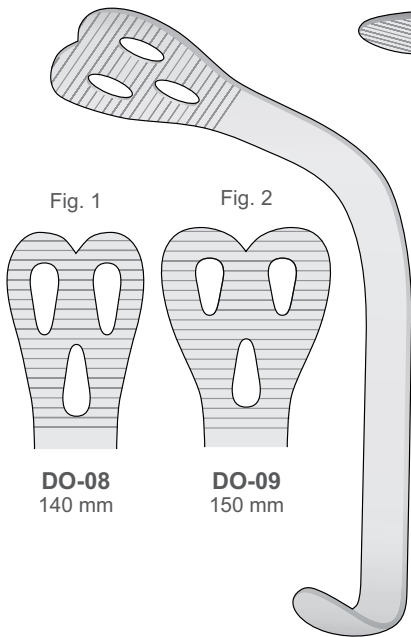
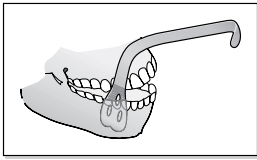


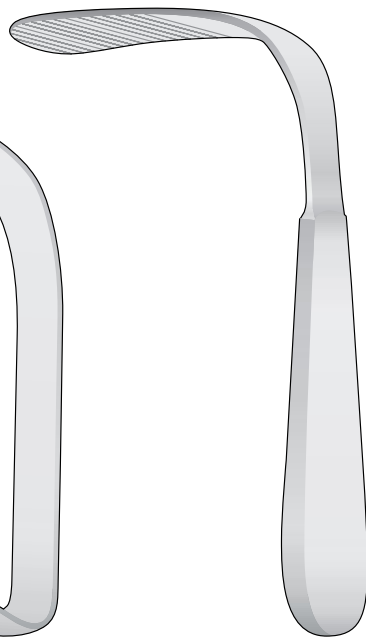
Fig. 1

Fig. 2

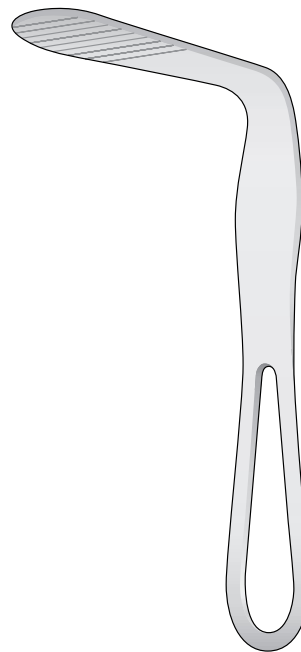
**DO-08**  
 140 mm

**DO-09**  
 150 mm

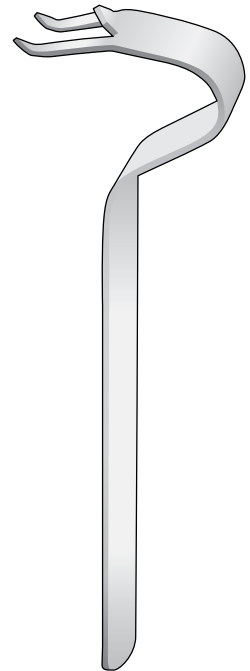
**WIEDER**  
**DO-08/DO-09**



**TOBOLD**  
**OM-08**  
 145 mm



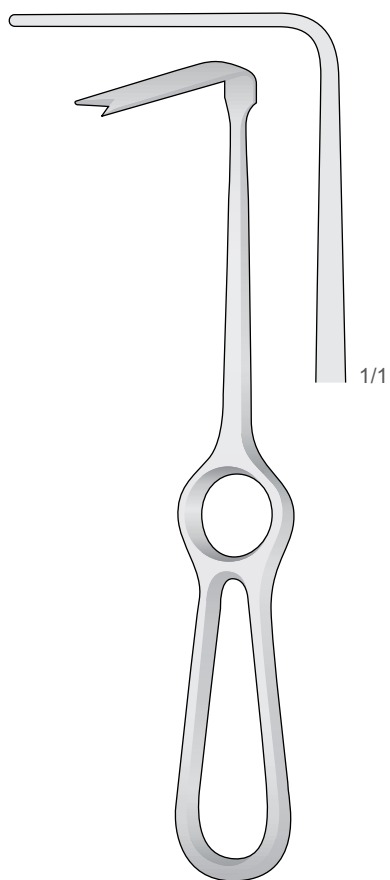
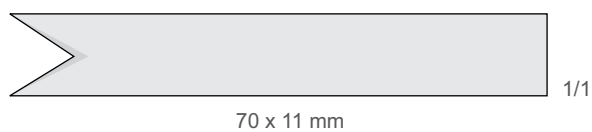
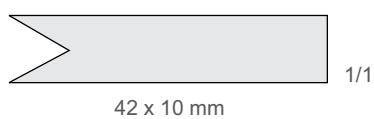
**HARTMANN**  
**OM-06**  
 150 mm



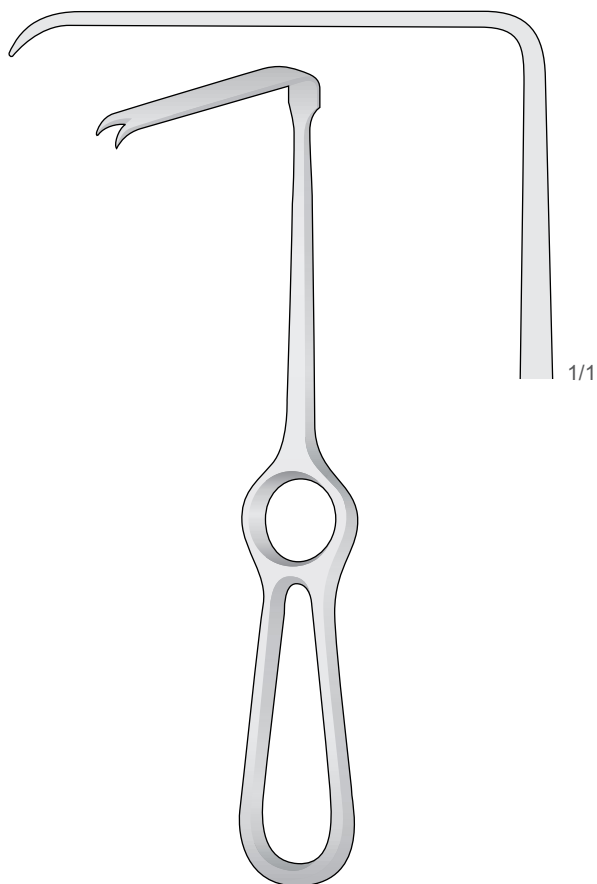
**OBWEGESER**  
**DO-40**  
 155 mm

Wundhaken  
Retractors  
Divaricatori  
Separadores  
Écarteurs

Ramushaken für Spina Nasalis  
Ramus Retractor for nasal spine  
Divaricatori per spina nasalis  
Separadores para spina nasalis  
Écarteurs pour spina nasalis



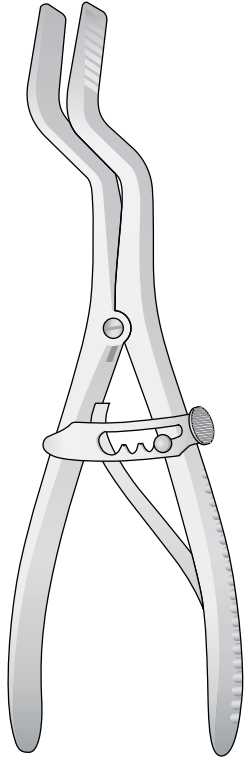
OBWEGESER  
**BT-67**  
220 mm



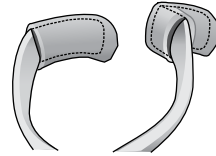
OBWEGESER  
**BT-68**  
220 mm

RETRACTORS

Mundsperrer  
 Mouth gags  
 Apribocca  
 Abrebocas  
 Écarteur buccal



ROSER KÖNIG  
**OM-60**  
 185 mm



Paar Einsätze aus Silikon für:  
 Pair of silicone inserts for:  
 Coppia di inserti in silicone per:  
 Pareja de inserto de silicone para:  
 Paire de inserts en silicon pour:

**OM-40 - OM-41**

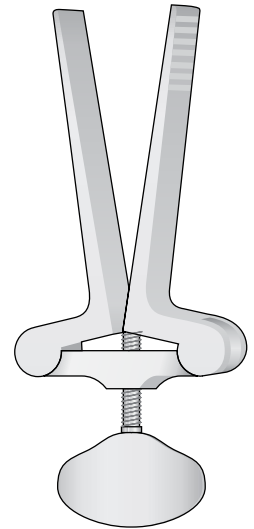
Ø 8 mm

Ø 11 mm



**OM-40R**  
 30 mm

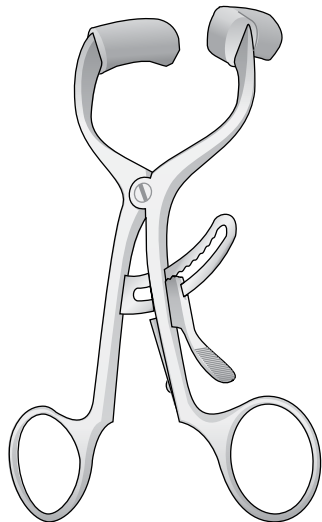
**OM-41R**  
 30 mm



HEISTER  
**OM-62**  
 135 mm

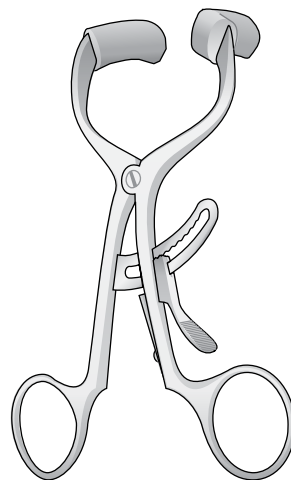
RETRACTORS

Für Erwachsene - For adults  
 Per adulti - Para adultos  
 Pour adultes



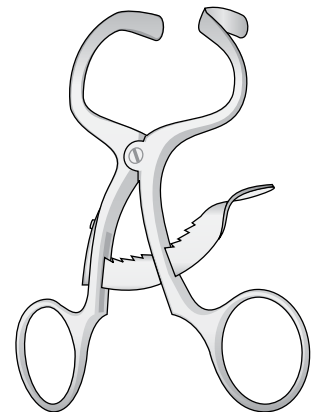
MOLT  
 DOYEN-JANSEN  
**OM-41**  
 140 mm

Für Erwachsene - For adults  
 Per adulti - Para adultos  
 Pour adultes



MOLT  
 DOYEN-COLLIN  
**OM-40**  
 120 mm

Für Kinder  
 For children  
 Per bambini  
 Para niños  
 Pour enfants



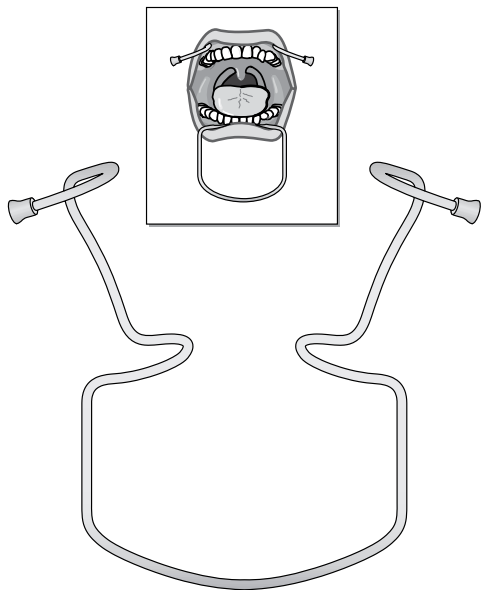
MOLT  
**OM-42**  
 100 mm



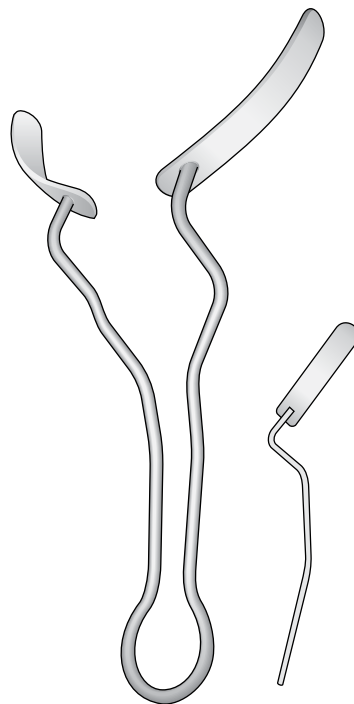
Mundsperrer  
 Mouth gags  
 Apribocca  
 Abrebocas  
 Écarteur buccal

Abhalter für gesamten Ober-bzw. Unterkiefer  
 Retractor for complete upper resp. Lower jaws  
 Retratore per arcata superiore e inferiore intera  
 Separadores para quijadas enteras inferiores y superiores  
 Écarteurs pour machoires complètes inférieures et supérieures

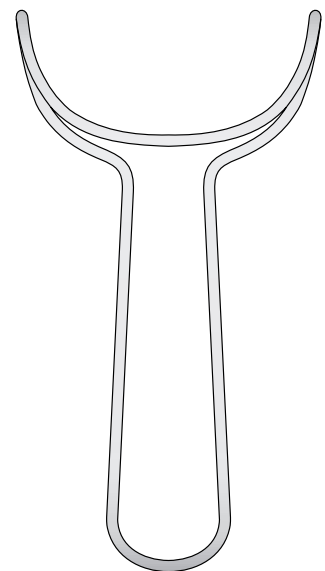
- OM-74** Fig. 0 100 x 95 mm
- OM-75** Fig. 1 115 x 105 mm
- OM-76** Fig. 2 115 x 110 mm
- OM-77** Fig. 3 125 x 115 mm



ORINGER  
**OM-74/OM-77**



MATY  
**OM-97**  
 170 mm



**OM-90**  
 150 mm

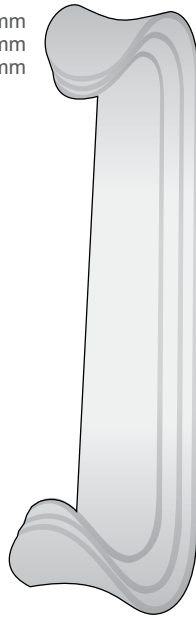
RETRACTORS



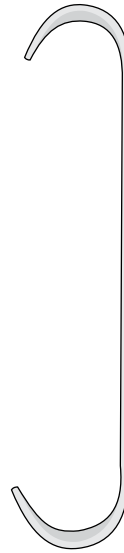
**BT-283**  
Set completo  
Set complete  
Komplettset  
Set complet  
Set completo  
**BT-284 + BT-285 + BT-286**

29 mm  
26 mm  
22 mm

28 mm  
38 mm  
44 mm



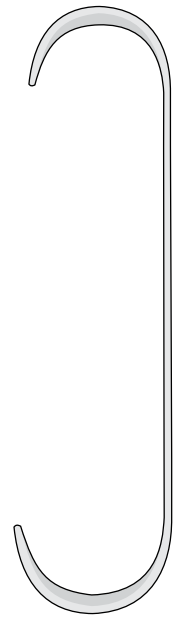
**ROUX  
BT-283**  
165 mm



**ROUX  
BT-284**  
20x22 mm  
25x28 mm

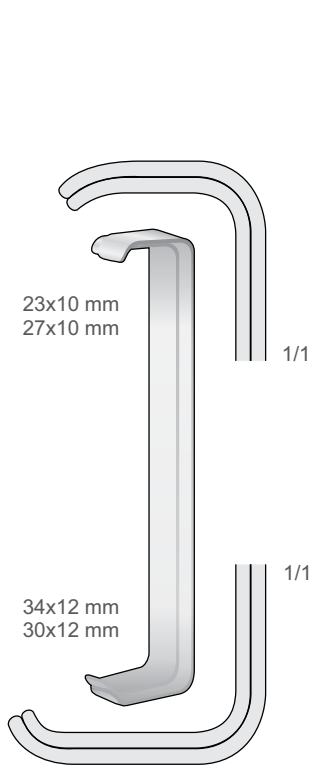


**ROUX  
BT-285**  
23x26 mm  
29x38 mm



**ROUX  
BT-286**  
29x29 mm  
34x44 mm

**RETRACTORS**



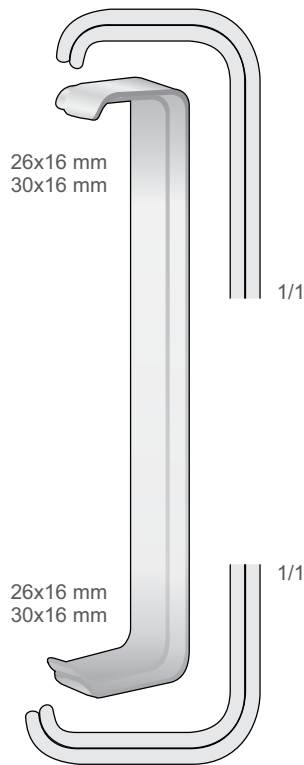
23x10 mm  
27x10 mm

1/1

34x12 mm  
30x12 mm

1/1

**FARABEUF  
BT-20**  
120 mm



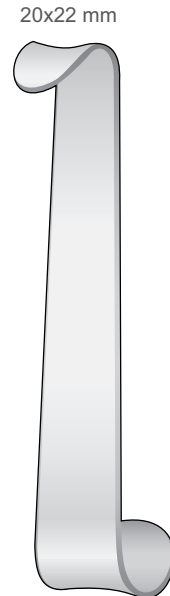
26x16 mm  
30x16 mm

1/1

26x16 mm  
30x16 mm

1/1

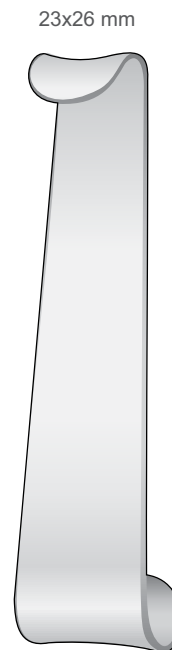
**FARABEUF  
BT-25**  
150 mm



20x22 mm

25x28 mm

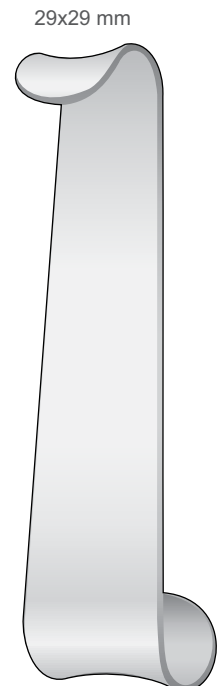
**ROUX-MAGNUS  
BT-287**  
150 mm



23x26 mm

29x38 mm

**ROUX-MAGNUS  
BT-288**  
160 mm



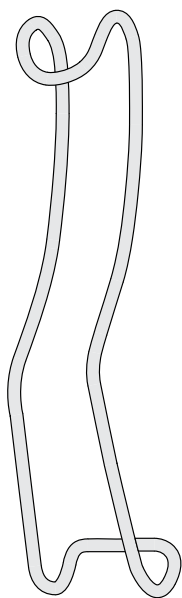
29x29 mm

34x44 mm

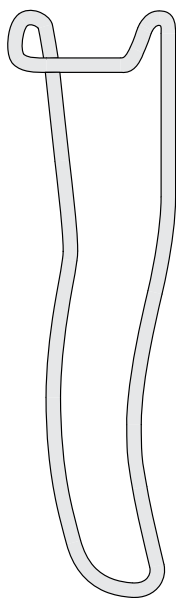
**ROUX-MAGNUS  
BT-289**  
170 mm



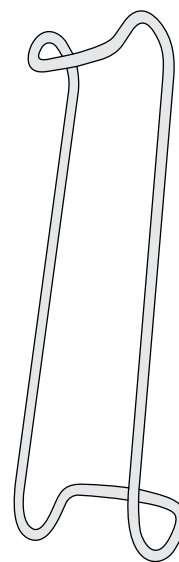
Wangenhalter  
 Cheek Retractors  
 Divaricatori per guance  
 Separador para mejillas  
 Écarteurs des joues



STERNBERG  
**OM-50**  
 160 mm

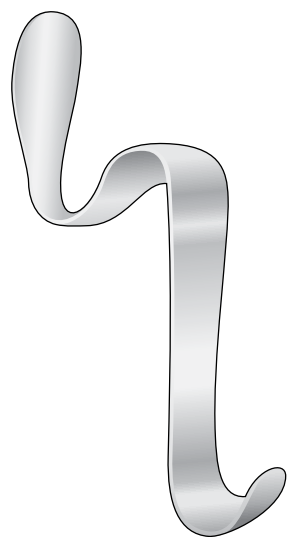


STERNBERG  
**OM-52**  
 160 mm



COLUMBIA  
**OM-67**  
 140 mm

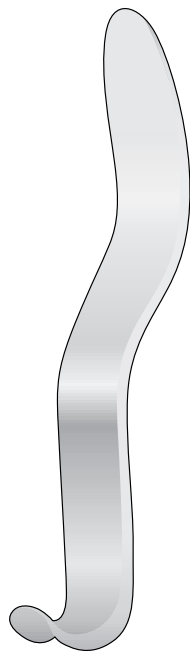
22 mm



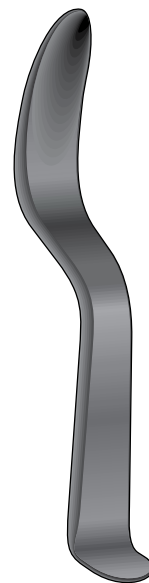
BISHOP  
**OM-61**  
 130 mm



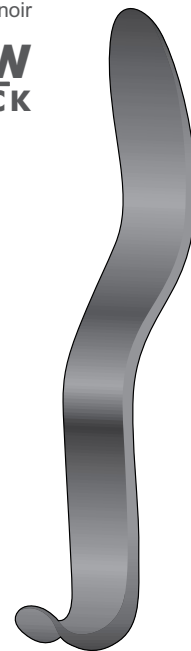
MINNESOTA  
**OM-55**  
 140 mm



CAWOOD-MINNESOTA  
**OM-66**  
 160 mm



MINNESOTA  
**OM-55B**  
 140 mm



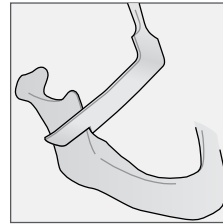
CAWOOD-MINNESOTA  
**OM-66B**  
 160 mm

Schwarz Verchromt  
 Black anodized  
 Cromato nero  
 Cromado en negro  
 Chromé noir

**NEW  
 BLACK**

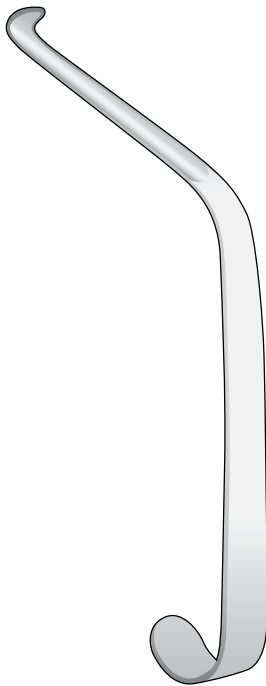
RETRACTORS





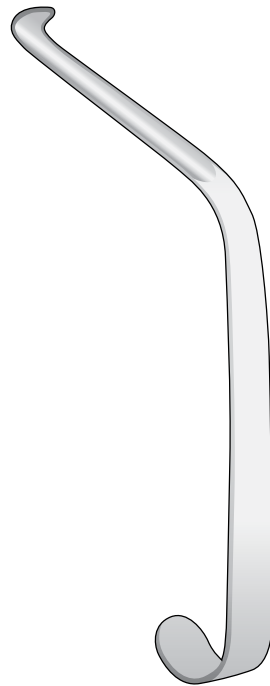
RETRACTORS

8 mm



OBWEGESER  
**DO-41**  
165 mm

10 mm



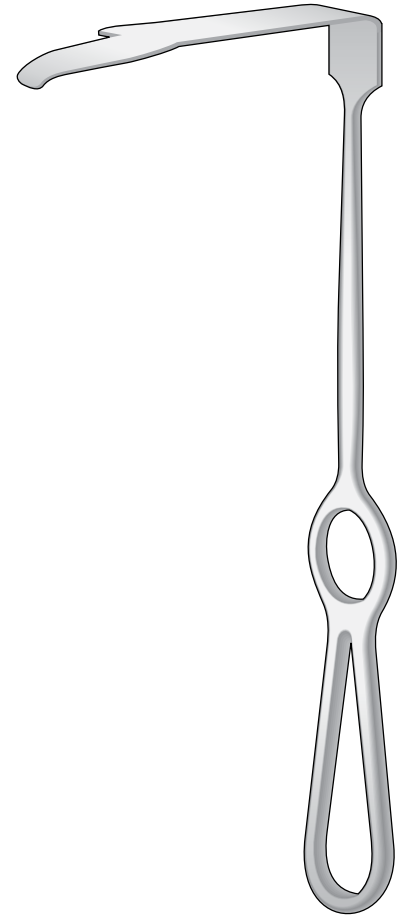
OBWEGESER  
**DO-142**  
165 mm

Ramus Retraktoren Recht  
Ramus Retractor Right  
Retrattore Ramus destro  
Separadores Ramus derecho  
Écarteur Ramus droites



MISCH  
**BT-158**  
210 mm

Ramus Retraktoren Link  
Ramus Retractor Left  
Retrattore Ramus sinistro  
Separadores Ramus izquierdo  
Écarteur Ramus gauches

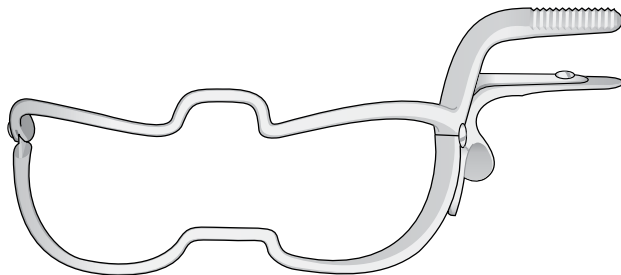


MISCH  
**BT-159**  
210 mm



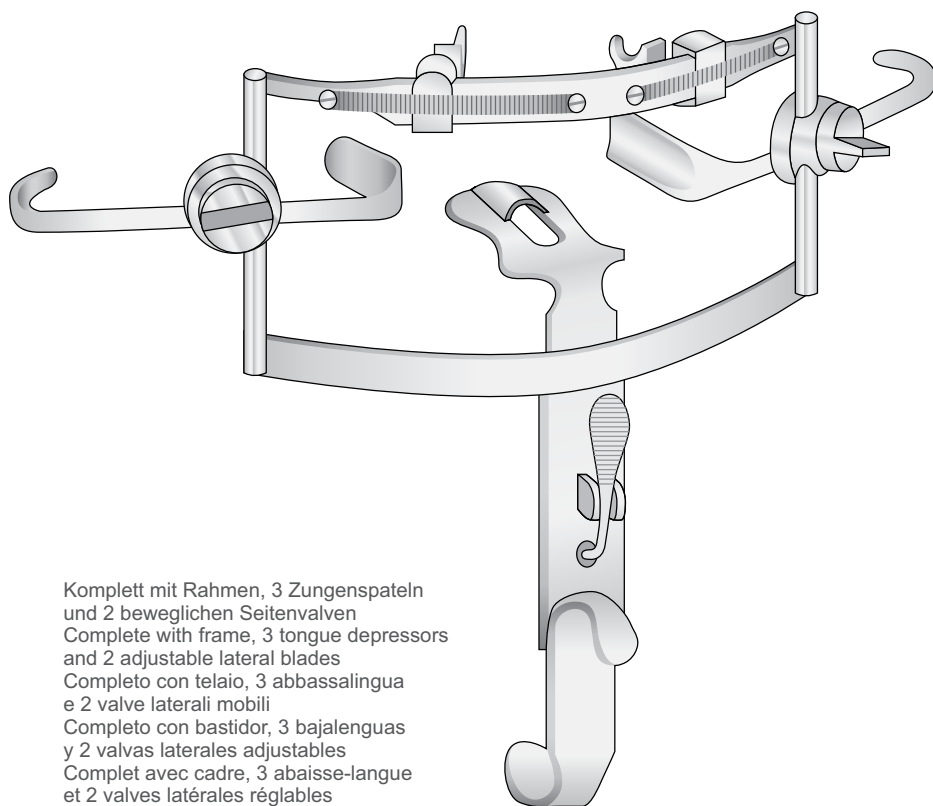


Mundsperrer  
 Mouth Gags  
 Apribocca  
 Abrebocas  
 Écarteur buccal



WHITEHEAD-JENNINGS

- OM-136** 90 mm
- OM-137** 110 mm
- OM-138** 130 mm
- OM-139** 150 mm



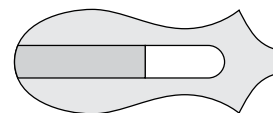
Komplett mit Rahmen, 3 Zungenspateln  
 und 2 beweglichen Seitenvalven  
 Complete with frame, 3 tongue depressors  
 and 2 adjustable lateral blades  
 Completo con telaio, 3 abbassalingua  
 e 2 valve laterali mobili  
 Completo con bastidor, 3 bajalenguas  
 y 2 valvas laterales ajustables  
 Complet avec cadre, 3 abaisse-langue  
 et 2 valves latérales réglables

DINGMANN  
**OM-110**  
 Set completo

DINGMANN

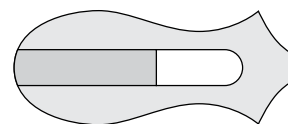
Zungenspatel  
 Tongue depressor  
 Abbassalingua  
 Bajalengua  
 Abaisse langue

Fig. 1



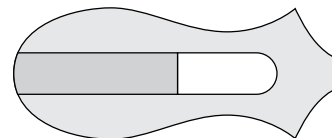
**OM-112**  
 65 x 25 mm

Fig. 2



**OM-113**  
 70 x 29 mm

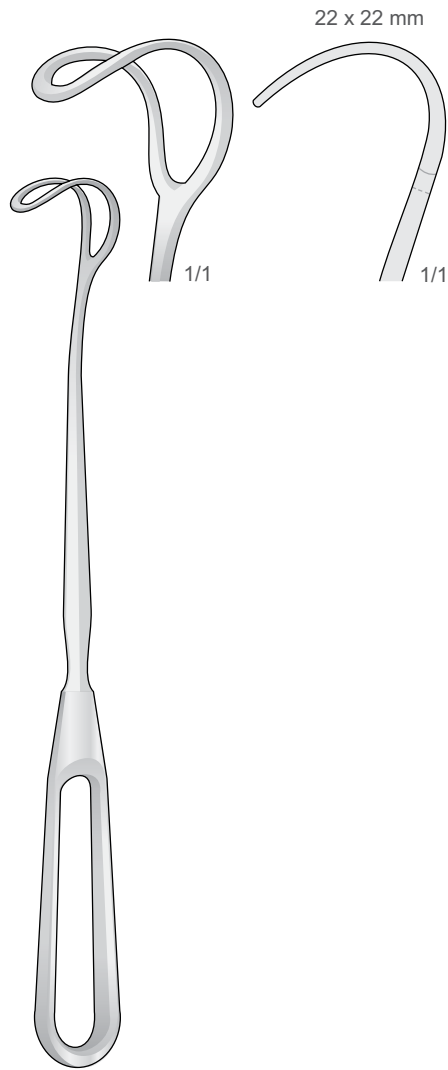
Fig. 3



**OM-114**  
 80 x 32 mm

RETRACTORS

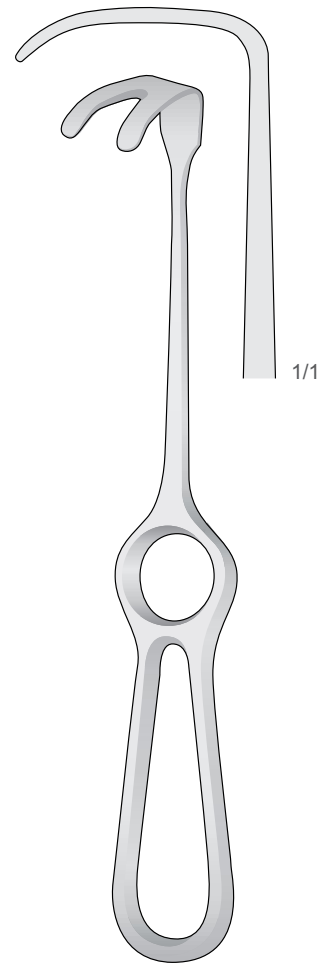




GREENE  
**BT-131**  
225 mm

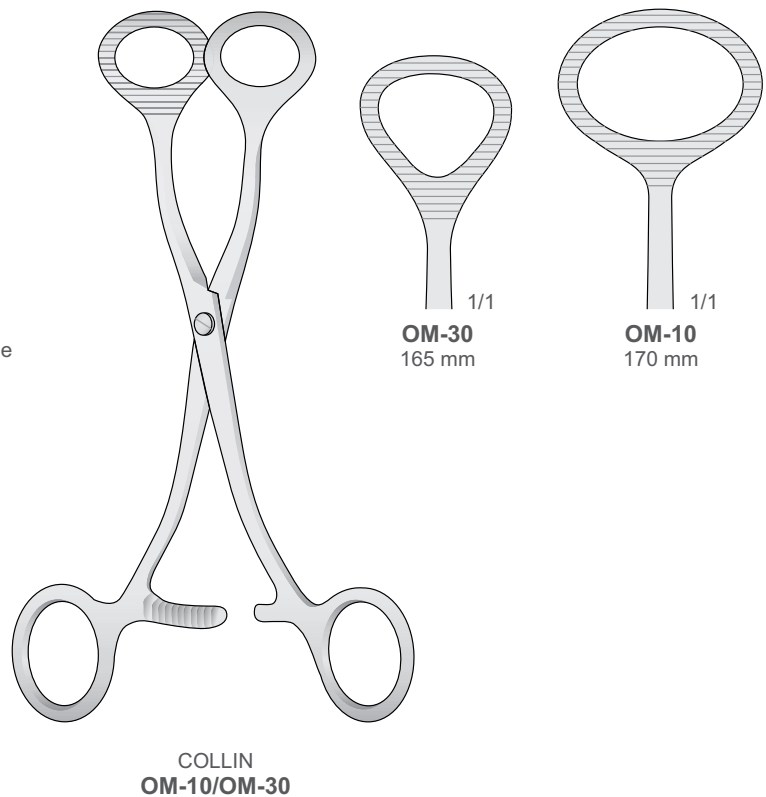
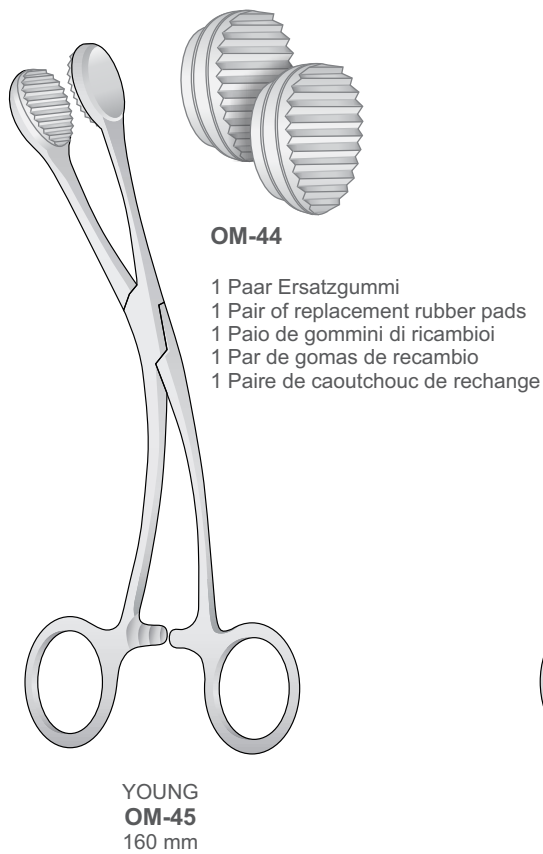
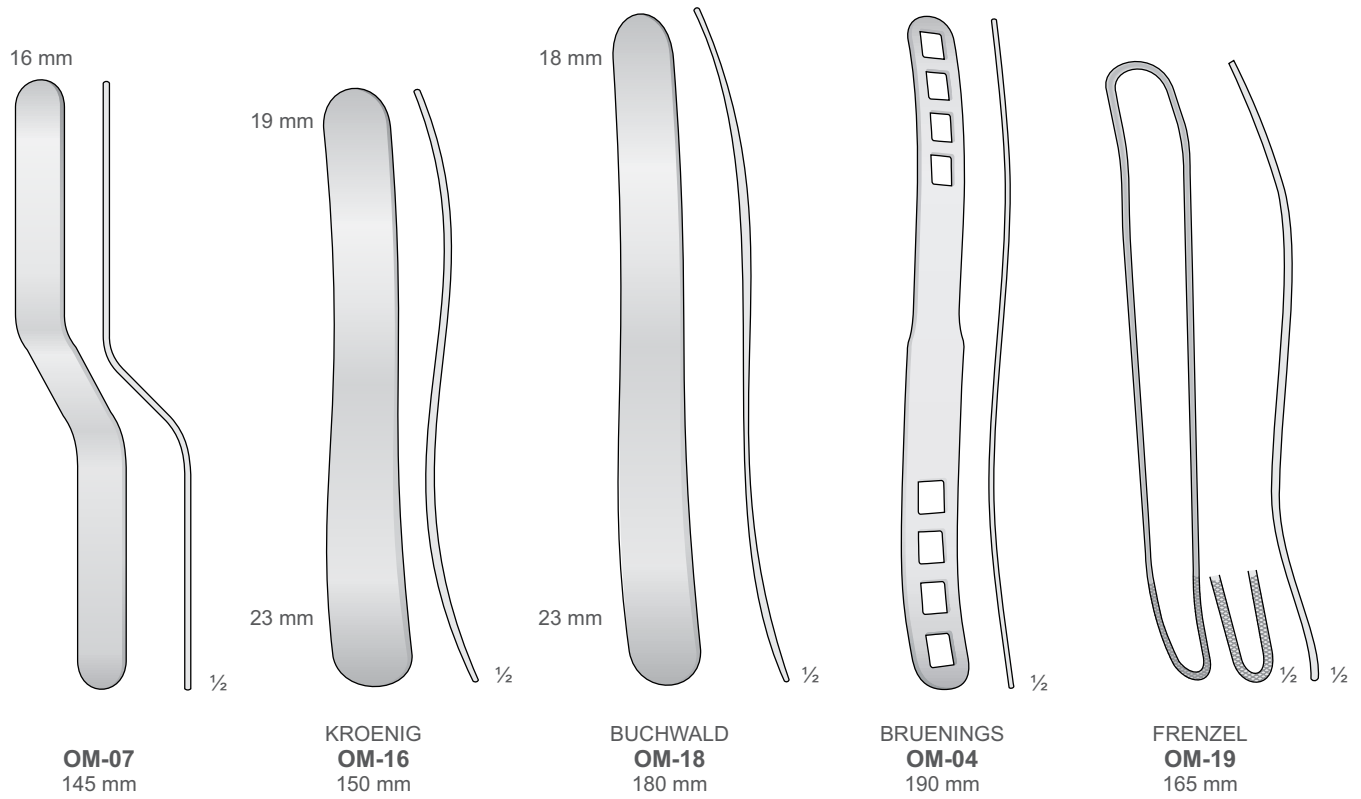


**BT-132**  
200 mm



WASSMUND  
**BT-69**  
220 mm

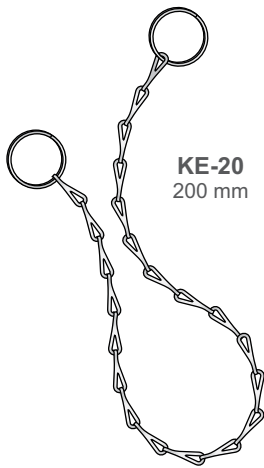
Zungenspatel - Zungenzangen  
 Tongue Depressors - Tongue Holding Forceps  
 Abbassalingua - Pinze tiralingua  
 Bajalenguas - Pinzas tira-lengua  
 Abaisse langues - Pincés tire-langue



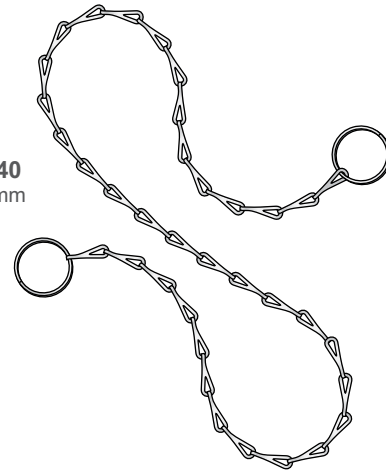
RETRACTORS



Kette und Mundstutzen  
Chain and Mouth Props  
Catene e Apribocca  
Cadena y Abre bocas  
Chaîne et Ouvre Bouche



**KE-20**  
200 mm



**KE-40**  
400 mm

Dampfsterilisation bis 134°C  
Autoclavable to 134°C  
Autoclavabile a 134°C  
Autoclave hasta 134°C  
Autoclavable jusqu'à 134°C

Packung mit 2 Stück  
Package with 2 units  
Confezione da 2 pezzi  
Caja con 2 unidades  
Boîte avec 2 pièces

Schwarzer Gummi  
Black Rubber  
Gomma nera  
Caucho negro  
Caoutchouc noir

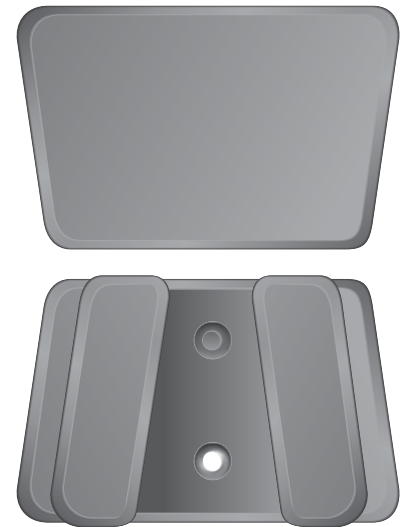
RETRACTORS



**OM-70**  
SMALL  
Klein, für Kinder  
Small, for children  
Piccolo, per bambini  
Pequeño, para niños  
Petit, pour enfants



**OM-71**  
MEDIUM  
Normal, für Erwachsene  
Regular, for adults  
Normale, per adulti  
Regular, para adultos  
Regulier, pour adultes



**OM-72**  
LARGE  
Groß, für Erwachsene  
Large, for adults  
Grande, per adulti  
Grande, para adultos  
Grand, pour adultes





we take a closer look

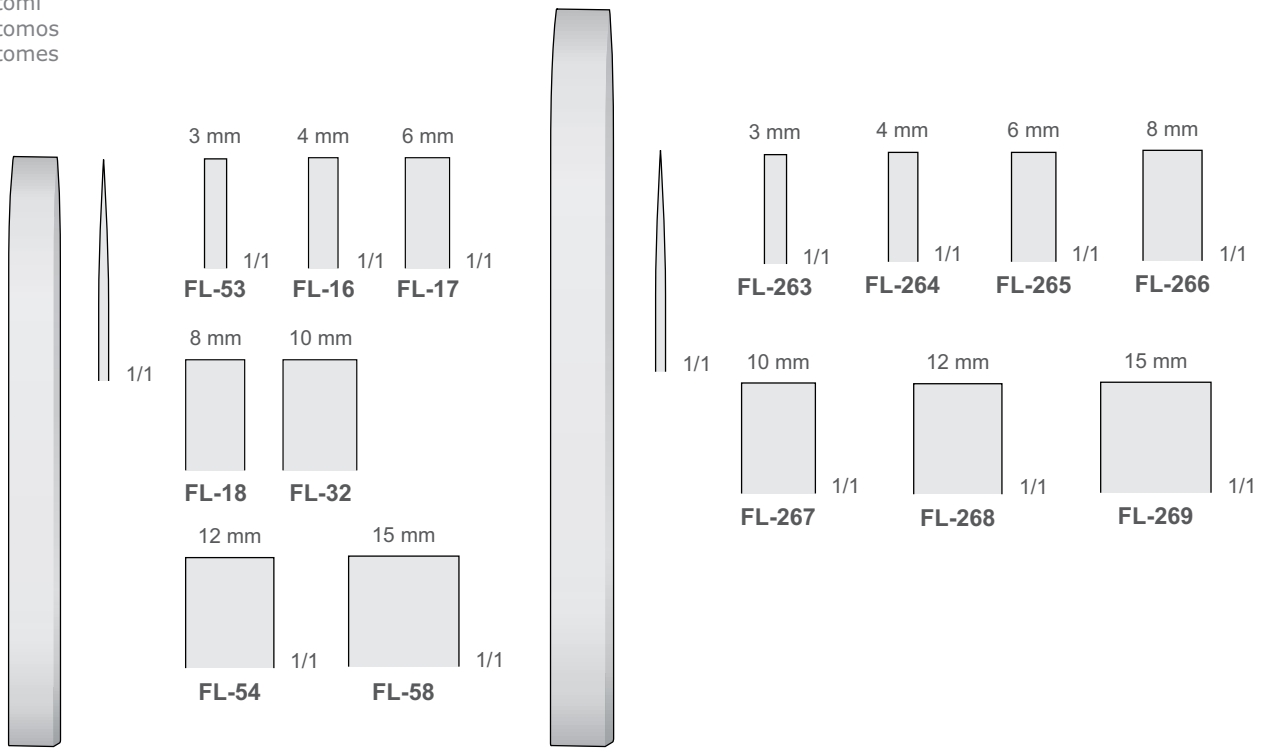
# + IMPLANTOLOGY



- Osteotomes and Chisels
- Mallets
- Periosteals
- Trephines
- Periosteals
- Osteotomes
- Trephines
- Bone & Tissue Harvest
- Accessories
- Measuring Instruments
- Bone Holding Forceps

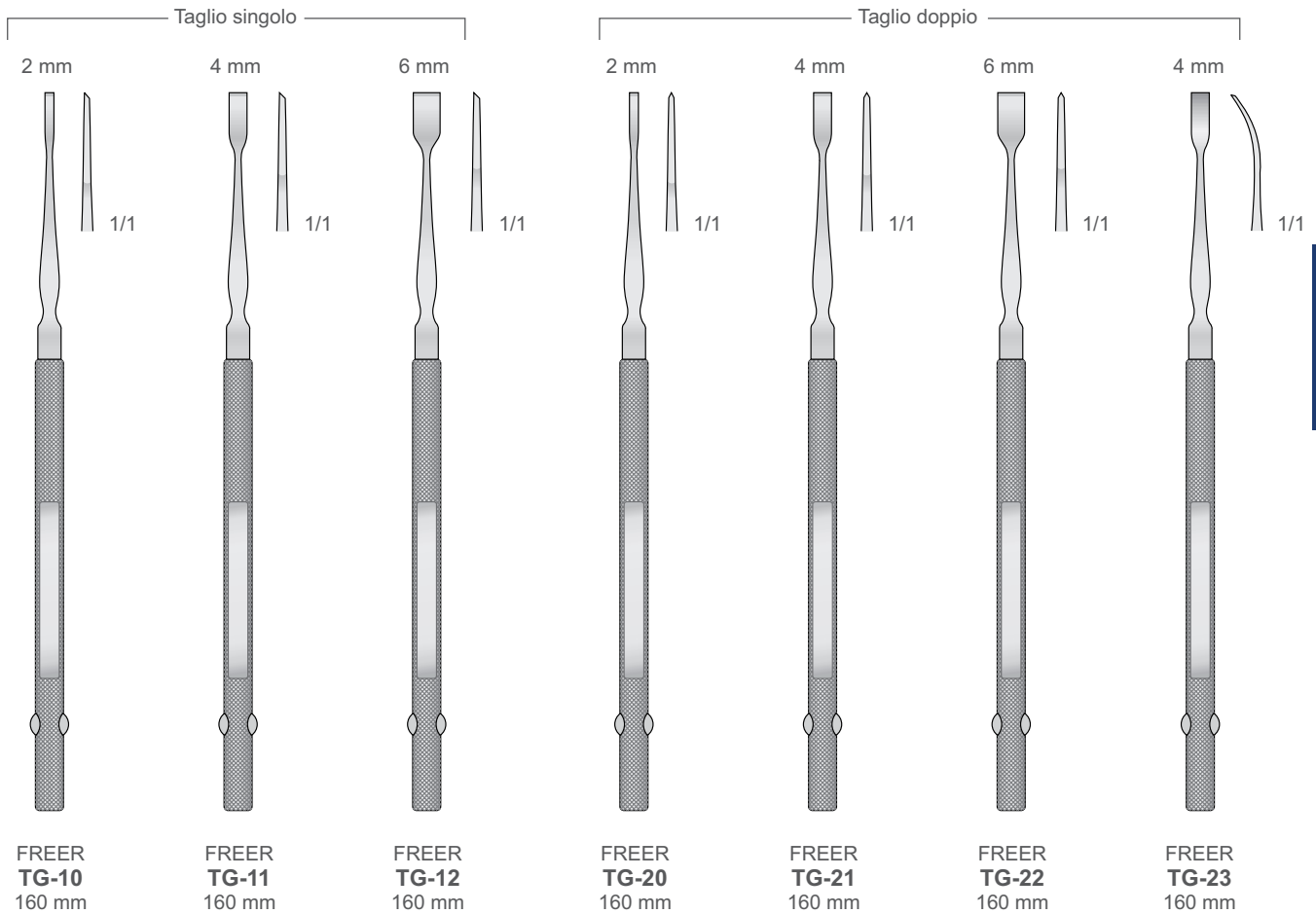


Osteotome  
 Osteotomes  
 Osteotomi  
 Osteótomos  
 Ostéotomes



MINI-LAMBOTTE  
**FL-16/FL-58**  
 125 mm

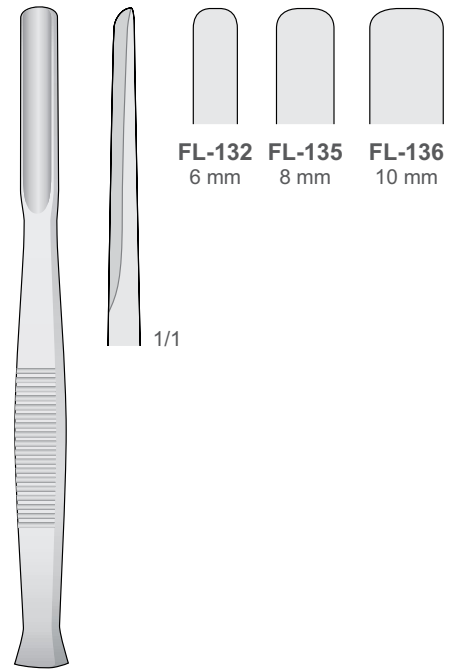
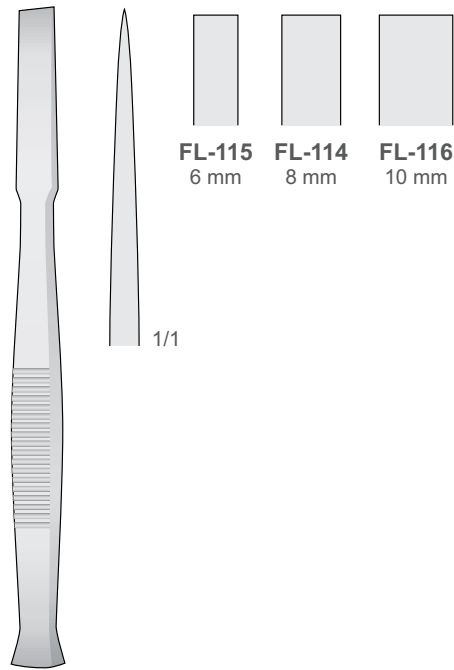
MINI-LAMBOTTE  
**FL-263/FL-269**  
 170 mm



IMPLANTOLOGY



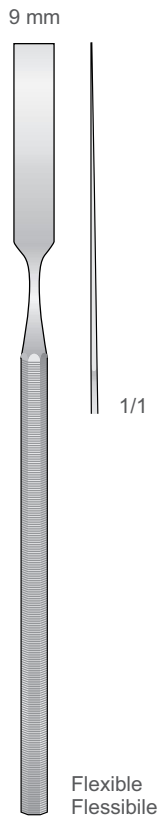
Osteotome - Meißel  
 Osteotomes - Gouges  
 Osteotomi - Sgorbie  
 Osteótomos - Gubias  
 Ostéotomes - Gouges



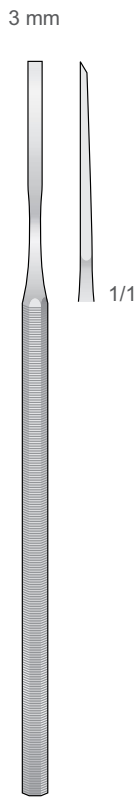
**FL-114/FL-116**  
140 mm

**FL-132/FL-136**  
140 mm

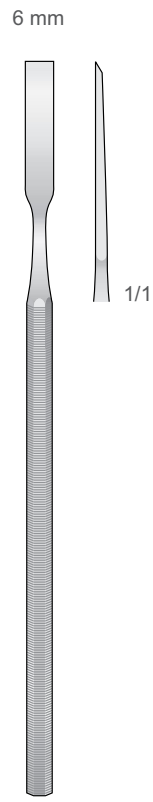
IMPLANTOLOGY



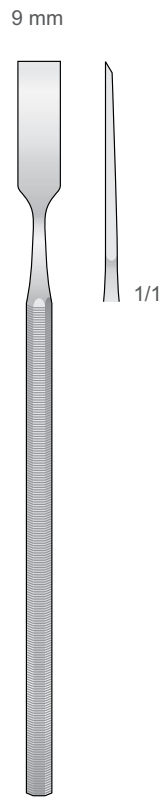
**TG-15**  
170 mm



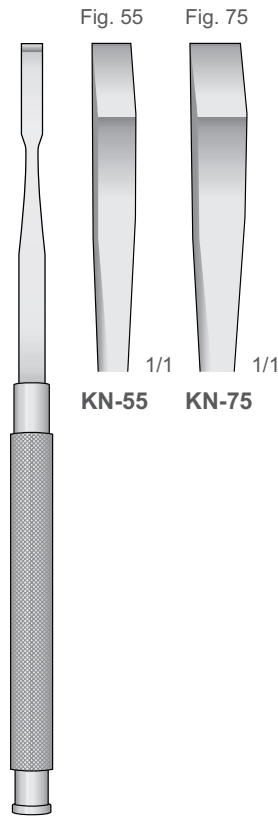
**TG-30**  
155 mm



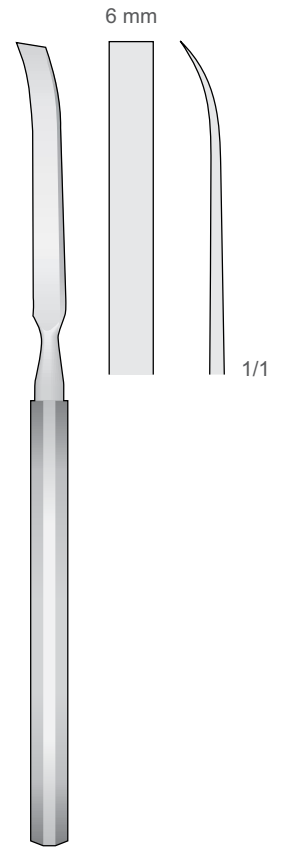
**TG-31**  
155 mm



**TG-32**  
155 mm



**KRAMER-NEVINS**  
**KN-55/KN-75**  
175 mm

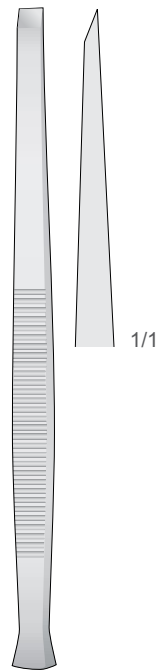


**DO-196**  
180 mm





Osteotome - Hohlmeissel  
 Osteotomes - Gouges  
 Osteotomi - Scalpelli  
 Osteótomos - Cinceles  
 Osteótomes - Scalpel



**FL-13**  
3 mm

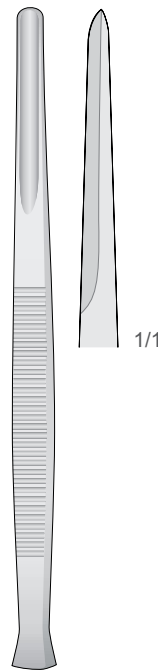


**FL-14**  
4 mm



**FL-15**  
5 mm

**PARTSCH**  
**FL-13/FL-15**  
140 mm



**FL-03**  
3 mm

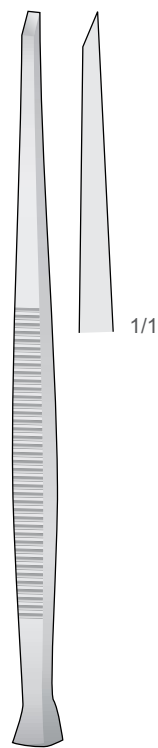


**FL-04**  
4 mm



**FL-05**  
5 mm

**PARTSCH**  
**FL-03/FL-05**  
140 mm



**FL-177**  
3 mm



**FL-179**  
4 mm



**FL-181**  
5 mm

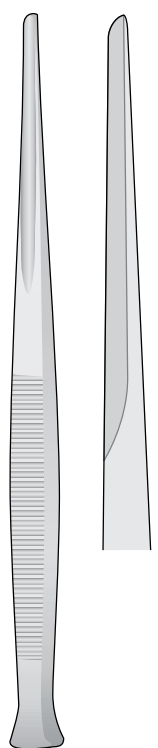


**FL-183**  
6 mm



**FL-184**  
7 mm

**PARTSCH**  
**FL-177/FL-184**  
170 mm



**FL-185**  
3 mm



**FL-186**  
4 mm



**FL-187**  
5 mm



**FL-188**  
6 mm



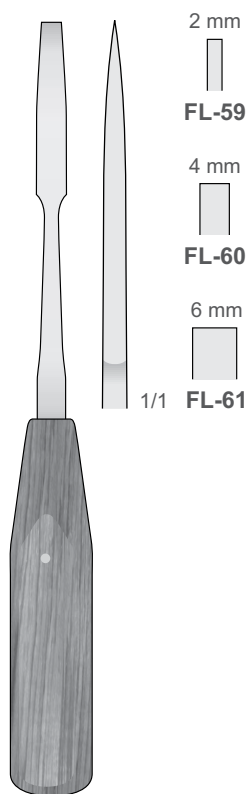
**FL-189**  
7 mm

**PARTSCH**  
**FL-185/FL-189**  
170 mm

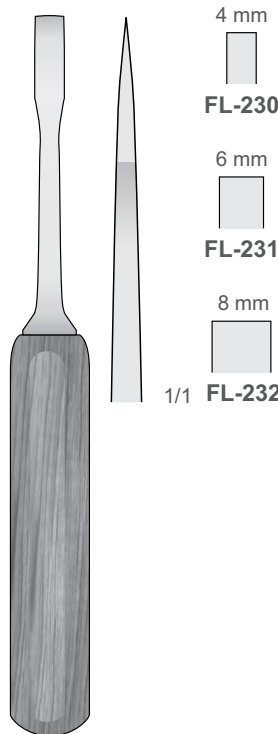
**IMPLANTOLOGY**



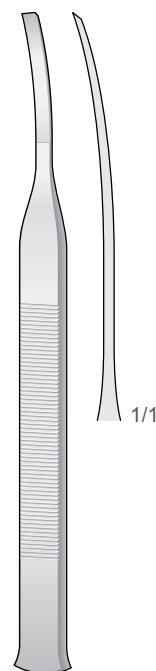
Osteotome - Meissel  
 Osteotomes - Chisels  
 Osteotomi - Scalpelli  
 Osteótomos - Cinceles  
 Ostéotomes - Burins



MINI-LEXER  
 FL-59/FL-61  
 200 mm



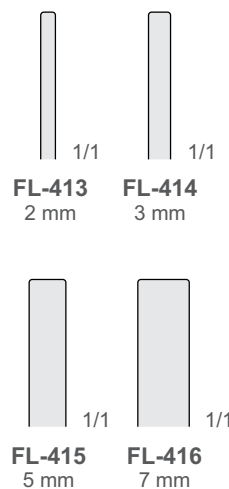
MINI-LEXER  
 FL-230/FL-232  
 180 mm



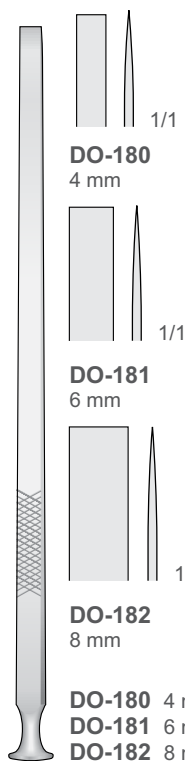
TESSIER  
 FL-411 5 mm  
 FL-412 7 mm  
 160 mm



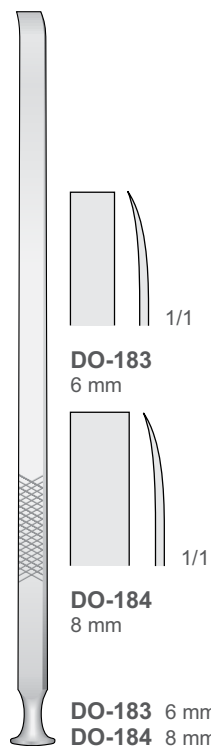
TESSIER  
 FL-413/FL-416  
 160 mm



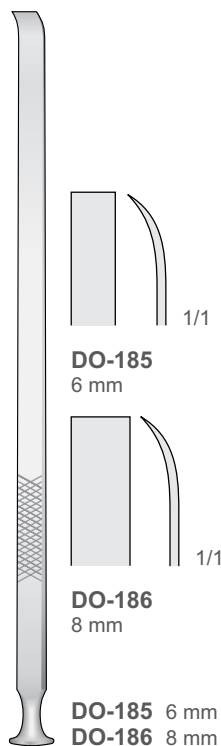
IMPLANTOLOGY



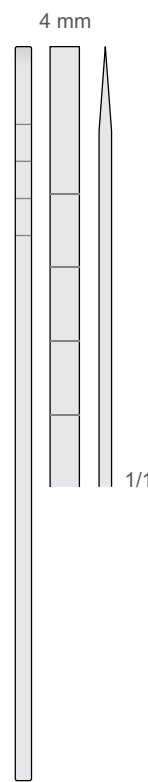
EPKER  
 DO-180/DO-182  
 180 mm



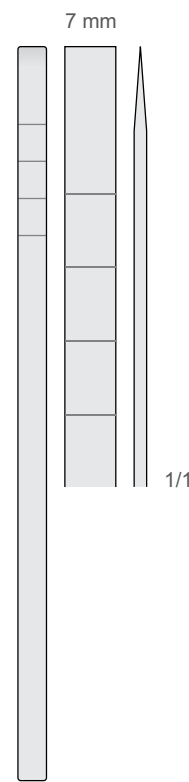
EPKER  
 DO-183/DO-184  
 180 mm



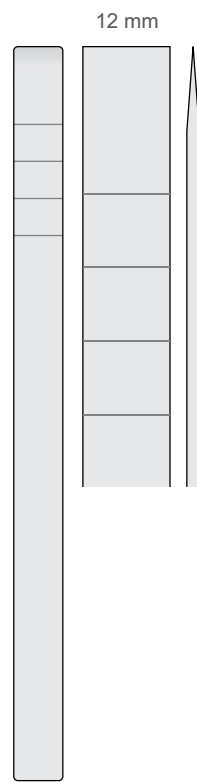
EPKER  
 DO-185/DO-186  
 180 mm



COTTLE  
 DO-140  
 180 mm



COTTLE  
 DO-141  
 180 mm

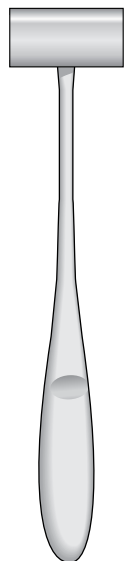


COTTLE  
 DO-143  
 180 mm



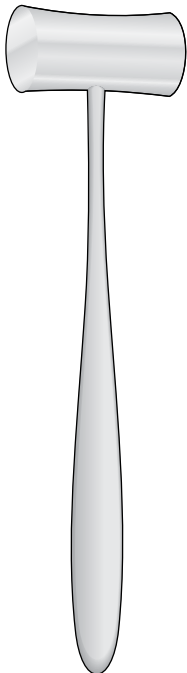
Chirurgische Hämmer  
Surgical mallets  
Martelli chirurgici  
Martillos quirúrgicos  
Maillets chirurgicaux

Ø 20 mm - 140 g



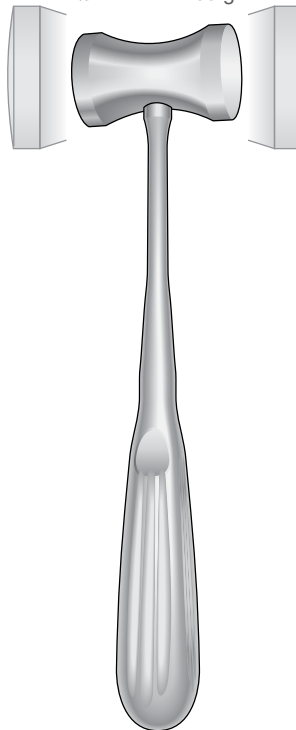
**FL-01**  
165 mm

Ø 25 mm - 300 g



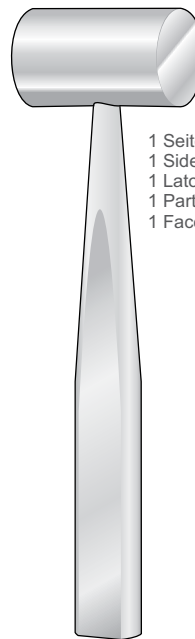
**LUCAE  
FL-10M**  
190 mm

Ø 27 mm - 135 g



**HAJEK  
FL-128**  
200 mm

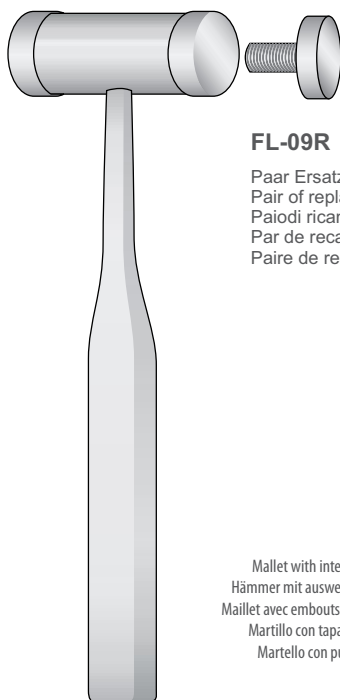
Ø 30 mm - 240 g



1 Seite flach - 1 Seite convex  
1 Side flat - 1 Side convex  
1 Lato piatto - 1 Lato convesso  
1 Parte plana - 1 Parte convexe  
1 Face plate - 1 Face convexe

**COTTLE  
FL-104**  
185 mm

Ø 20 mm - 160 g

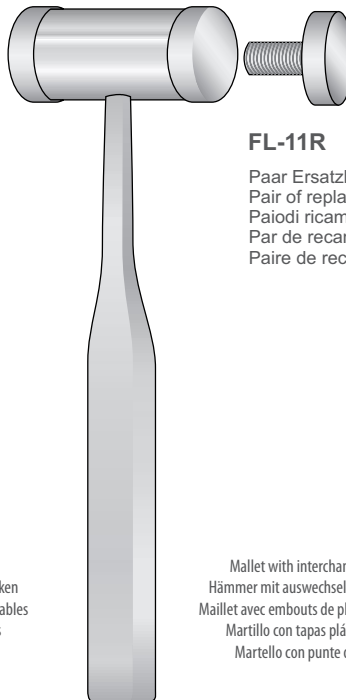


**FL-09R**  
Paar Ersatzbacken  
Pair of replacement  
Paioni ricambio  
Par de recambio  
Paire de rechange

Mallet with interchangeable plastic disks  
Hämmer mit auswechselbaren Kunststoffbacken  
Maillet avec embouts de plastique interchangeables  
Martillo con tapas plásticas reemplazables  
Martello con punte di ricambi in teflon

**MEAD  
FL-09**  
190 mm

Ø 25 mm - 200 g

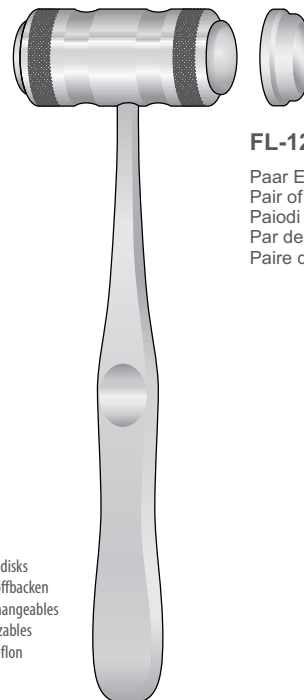


**FL-11R**  
Paar Ersatzbacken  
Pair of replacement  
Paioni ricambio  
Par de recambio  
Paire de rechange

Mallet with interchangeable plastic disks  
Hämmer mit auswechselbaren Kunststoffbacken  
Maillet avec embouts de plastique interchangeables  
Martillo con tapas plásticas reemplazables  
Martello con punte di ricambi in teflon

**MEAD  
FL-11**  
200 mm

Ø 26 mm - 320 g



**FL-12R**  
Paar Ersatzbacken  
Pair of replacement  
Paioni ricambio  
Par de recambio  
Paire de rechange

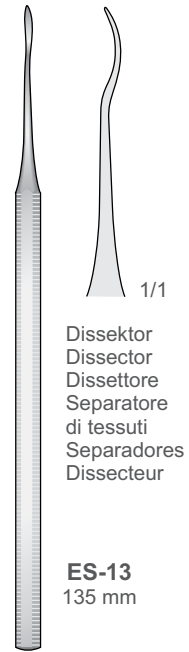
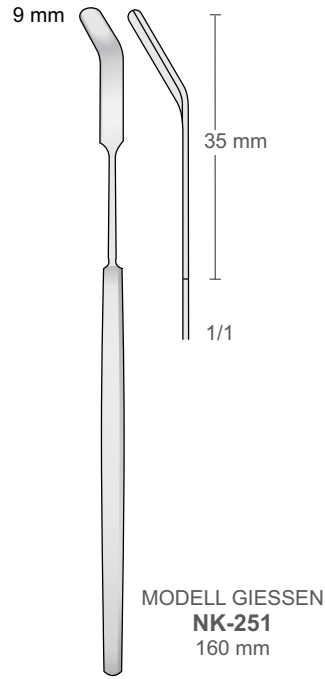
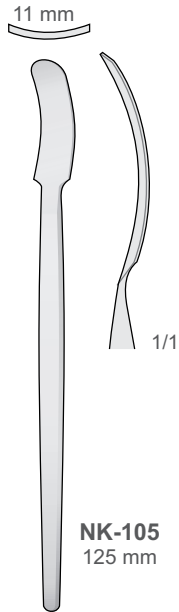
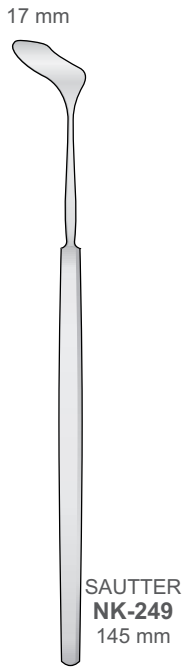
**MEAD  
FL-12**  
190 mm

**IMPLANTOLOGY**



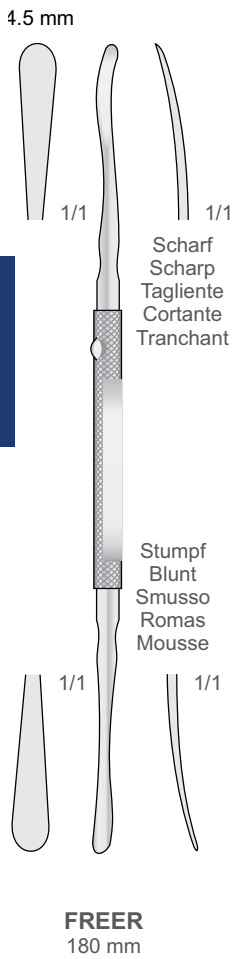
Sinus Lift Retraktoren - Sinus Lift Retractors  
 Divaricatori per Sinus Lift - Separadores para Sinus Lift  
 Écarteurs pour Sinus Lift

Raspatorien  
 Periosteals  
 Scollaperiostei  
 Periostótomos  
 Rugines



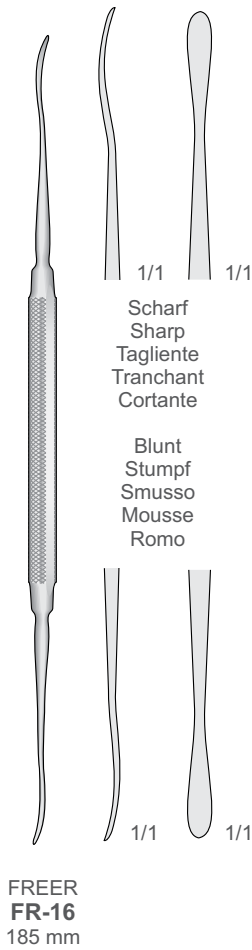
Dissektor  
 Dissector  
 Dissettore  
 Separatore  
 di tessuti  
 Separadores  
 Dissecteur

IMPLANTOLOGY



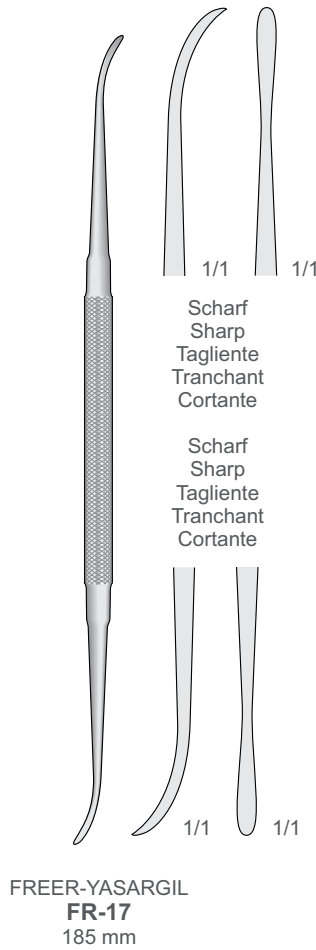
Scharf  
 Scharp  
 Tagliente  
 Cortante  
 Tranchant

Stumpf  
 Blunt  
 Smusso  
 Romas  
 Mousse



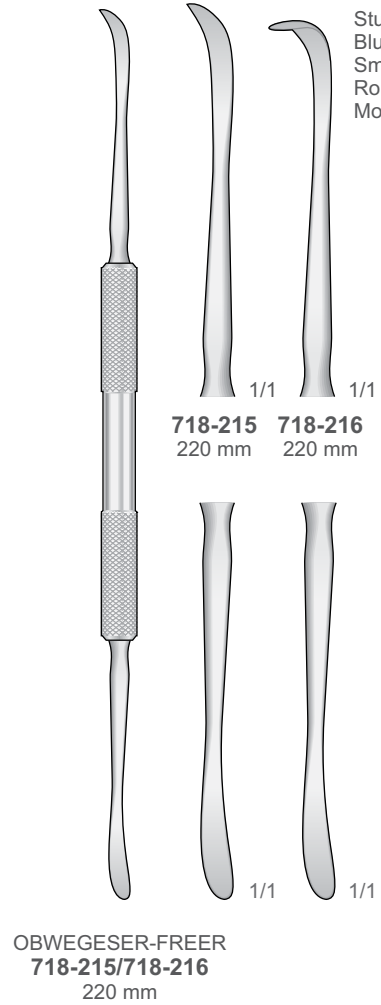
Scharf  
 Sharp  
 Tagliente  
 Tranchant  
 Cortante

Blunt  
 Stumpf  
 Smusso  
 Mousse  
 Romo



Scharf  
 Sharp  
 Tagliente  
 Tranchant  
 Cortante

Scharf  
 Sharp  
 Tagliente  
 Tranchant  
 Cortante



Stumpf  
 Blunt  
 Smussi  
 Romo  
 Mousse



Trepanbohrer  
 Trephines  
 Tréphine  
 Trépanos  
 Trépan

**Combination Trocar-Trephine Instruments**

Bestehend aus einem Trokar, einer gezahnten Trephine und einem Kolben zur Entnahme von Knochentransplantaten aus Tibia und Beckenkamm mittels eines geschlossenen Verfahrens

Consisting of trocar, a toothed trephine and a plunger for taking tibial and iliac bone grafts through a closed technique

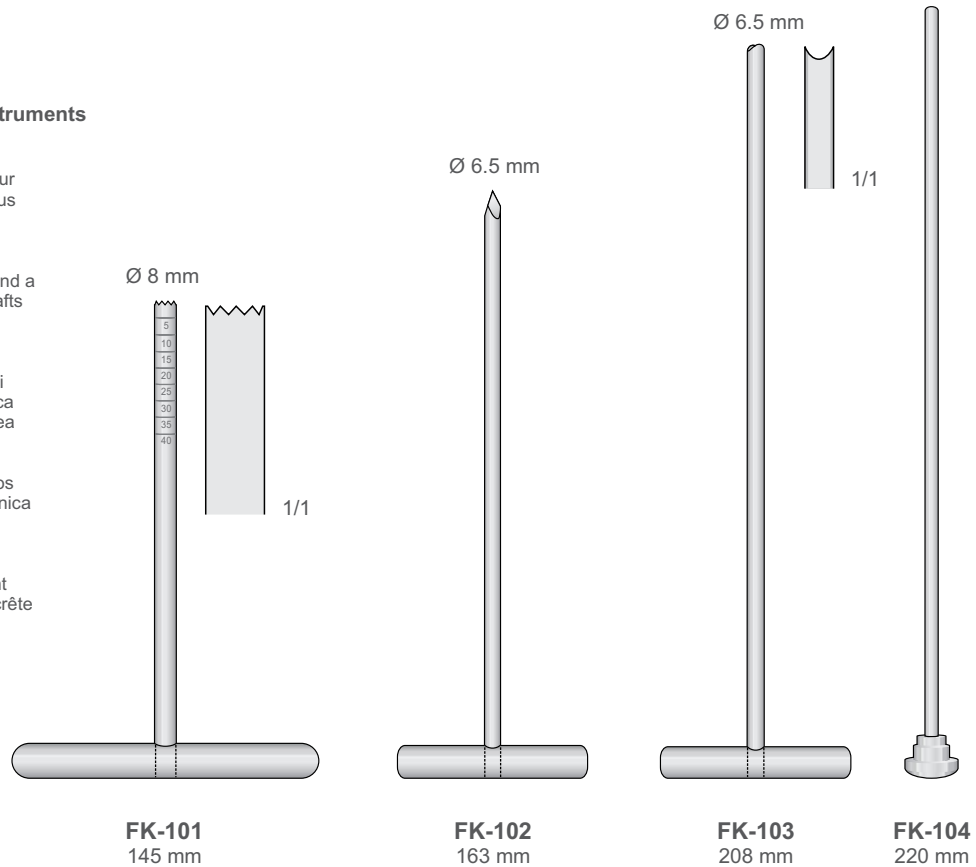
Composto di un trequarti, una camicia dentata ed un pistone per il prelievo degli innesti ossei dalla tibia e dalla cresta iliaca tramite una tecnica chirurgica intracutanea

Compuesto por un trócar, un trépano dentado y un émbolo para obtener injertos óseos tibiales e iliacos mediante una técnica cerrada

Composé d'un trocart, d'une tréphine dentée et d'un piston pour le prélèvement de greffes osseuses de la tibia ou de la crête iliaque par une technique fermée

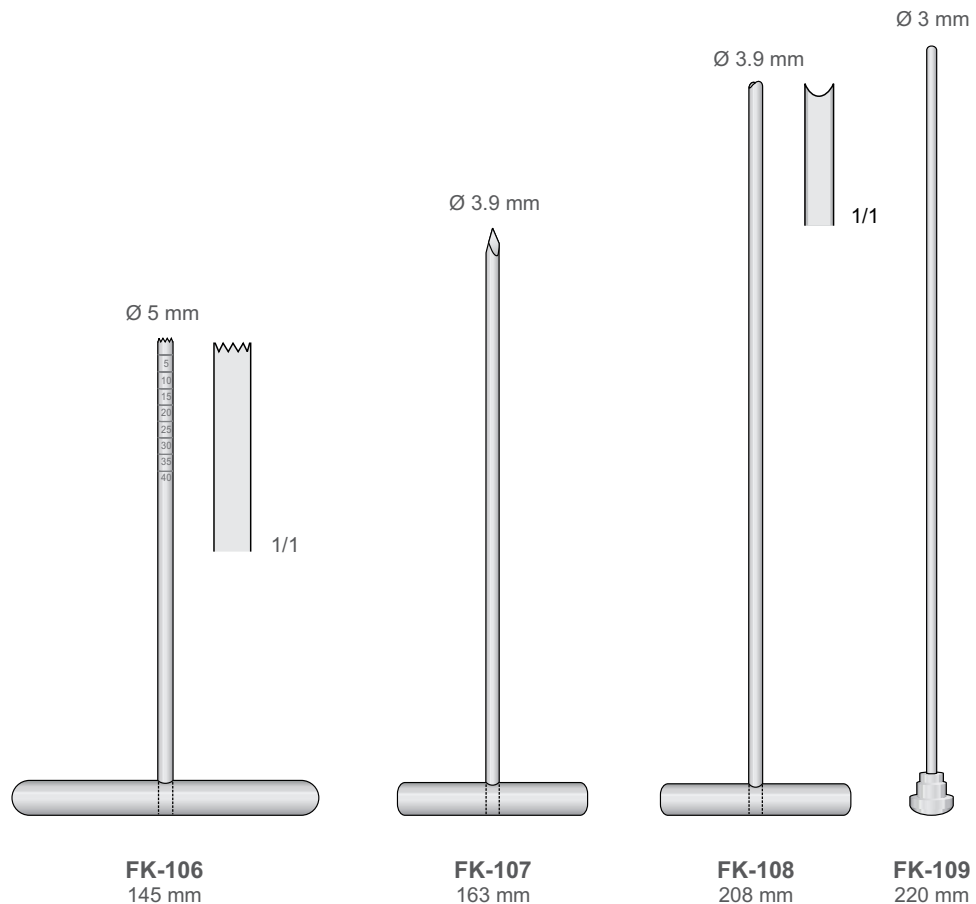
**FK-100**

Komplettset mit 4 Teilen  
 Set complete with 4 pieces  
 Set completo di 4 pezzi  
 Set completo con 4 piezas  
 Set complet avec 4 pièces



**FK-105**

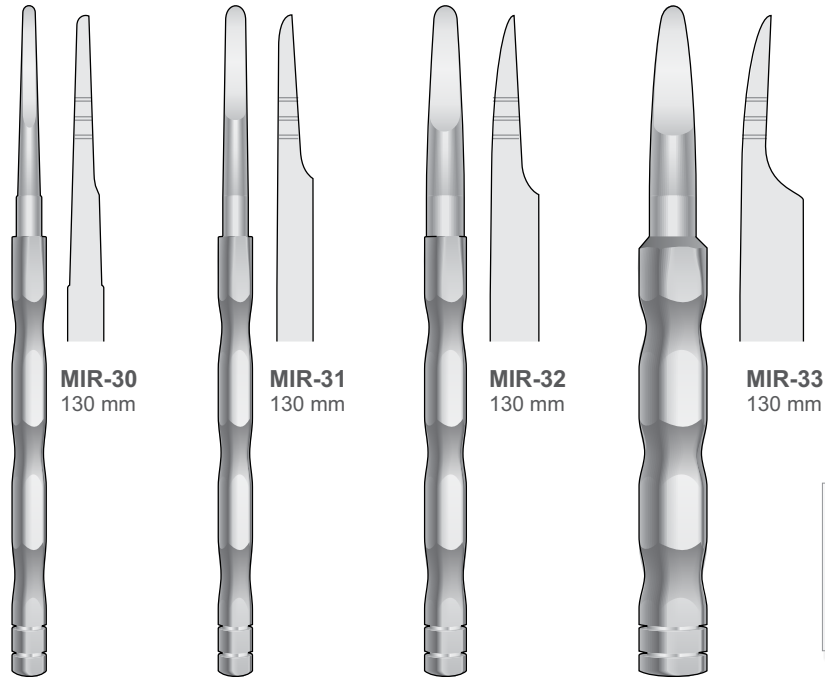
Komplettset mit 4 Teilen  
 Set complete with 4 pieces  
 Set completo di 4 pezzi  
 Set completo con 4 piezas  
 Set complet avec 4 pièces



IMPLANTOLOGY



Implantologie Instrumente  
 Implantology Instruments  
 Strumenti per implantologia  
 Instrumentos para Implantología  
 Instruments pour Implantologie



**MIR-30**  
130 mm

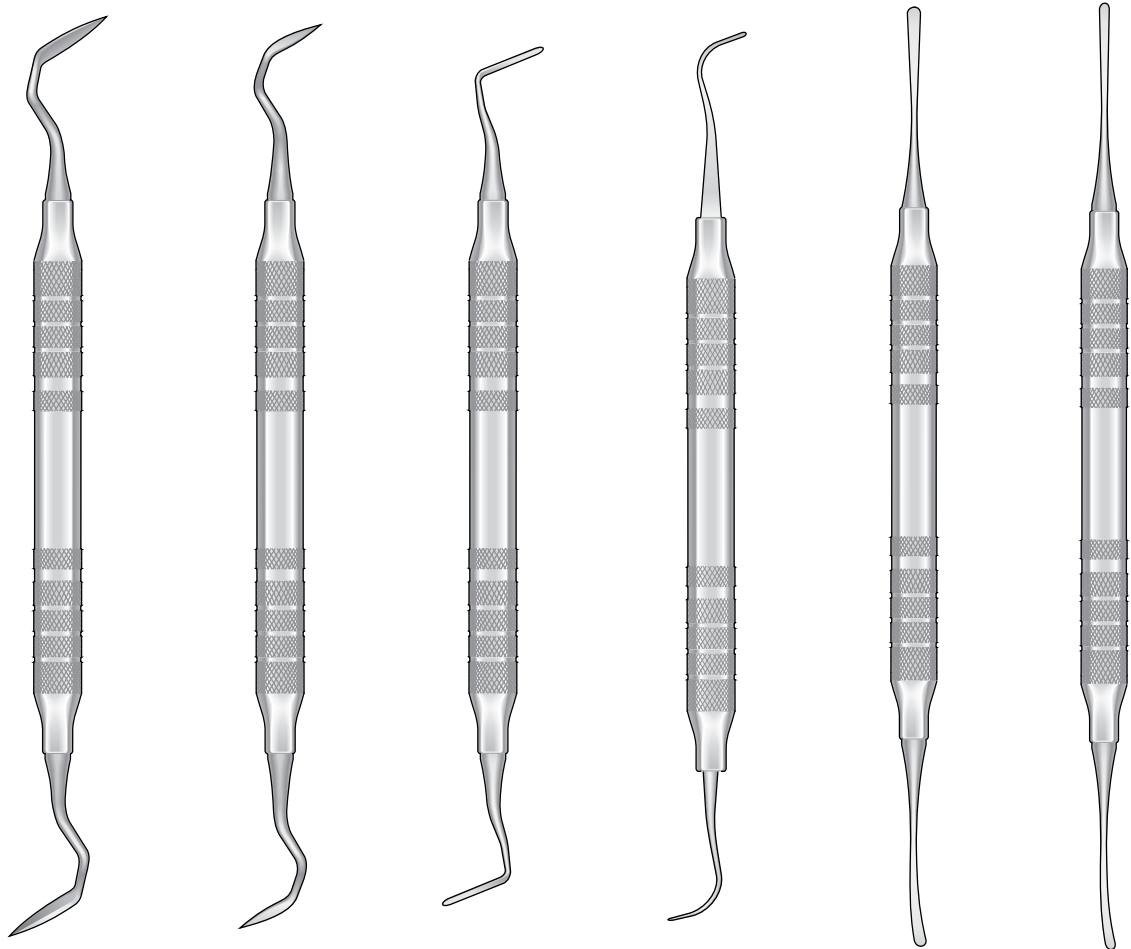
**MIR-31**  
130 mm

**MIR-32**  
130 mm

**MIR-33**  
130 mm

**BONE EXPANDERS**  
 Distraktoren für Knochenleiste  
 Distracteurs de crête osseuse  
 Expansores de cresta ósea  
 Distrattori per cresta ossea

**TUNNELING INSTRUMENTS**  
 Tunnelierinstrumente | Instruments pour tunnellation | Instrumentos para tunelización | Strumenti per tunneling



**UST-1/2ML**

**UST-1/2MS**

**UST-KPA**

**USS-YG7/8**

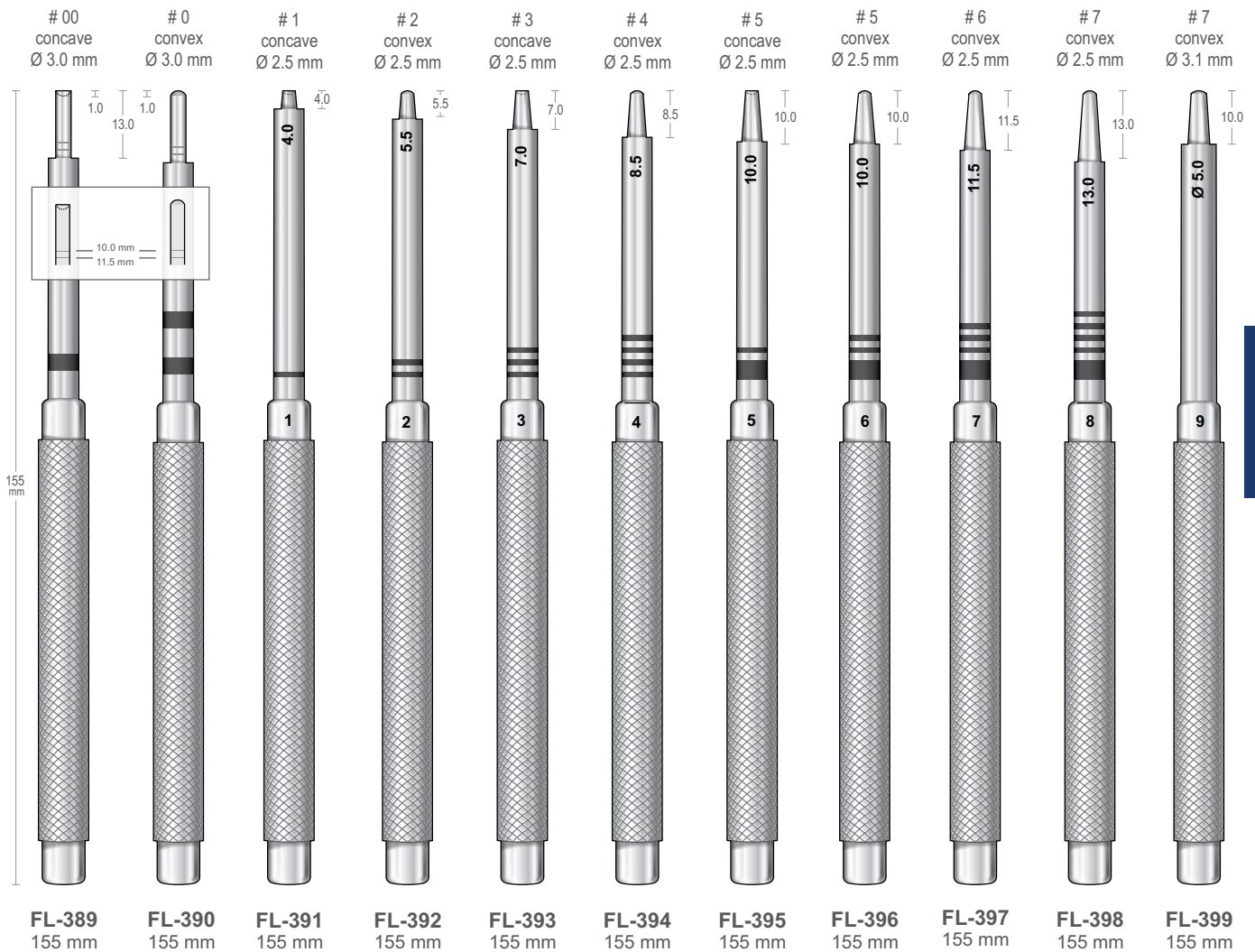
**UST-MP**

**UST-MPA**

IMPLANTOLOGY



Osteotome  
 Osteotomes  
 Osteotomi  
 Osteótomos  
 Osthéotomes



IMPLANTOLOGY



Osteotome  
 Osteotomes  
 Osteotomi  
 Osteótomos  
 Ostéotomes

# 1	Diam.
0	Ø 1.60
7.5	Ø 1.80
10	Ø 2.00
13.5	Ø 2.40
15.5	Ø 3.60

# 2	Diam.
0	Ø 1.90
7.5	Ø 2.20
10	Ø 2.35
13.5	Ø 3.30
15.5	Ø 3.40
23.5	Ø 4.50

# 3	Diam.
0	Ø 2.80
7.5	Ø 3.20
10.5	Ø 3.35
13.5	Ø 3.60
21	Ø 4.40

# 4	Diam.
0	Ø 3.10
7.5	Ø 3.70
10.5	Ø 3.90
15.5	Ø 4.30

# 5	Diam.
0	Ø 3.90
10	Ø 5.00
13	Ø 5.20
20.5	Ø 6.30

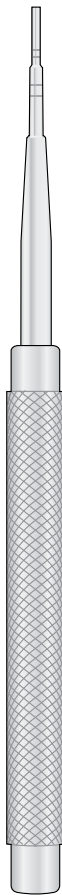
# 6	Diam.
0	Ø 5.50
10	Ø 6.20
13	Ø 6.30

# 1  
 Ø 1.6 mm



FL-120  
 155 mm

# 2  
 Ø 1.9 mm



FL-121  
 155 mm

# 3  
 Ø 2.8 mm



FL-122  
 155 mm

# 4  
 Ø 3.10 mm



FL-123  
 155 mm

# 5  
 Ø 3.90 mm



FL-124  
 155 mm

# 6  
 Ø 5.50 mm



FL-125  
 155 mm

IMPLANTOLOGY



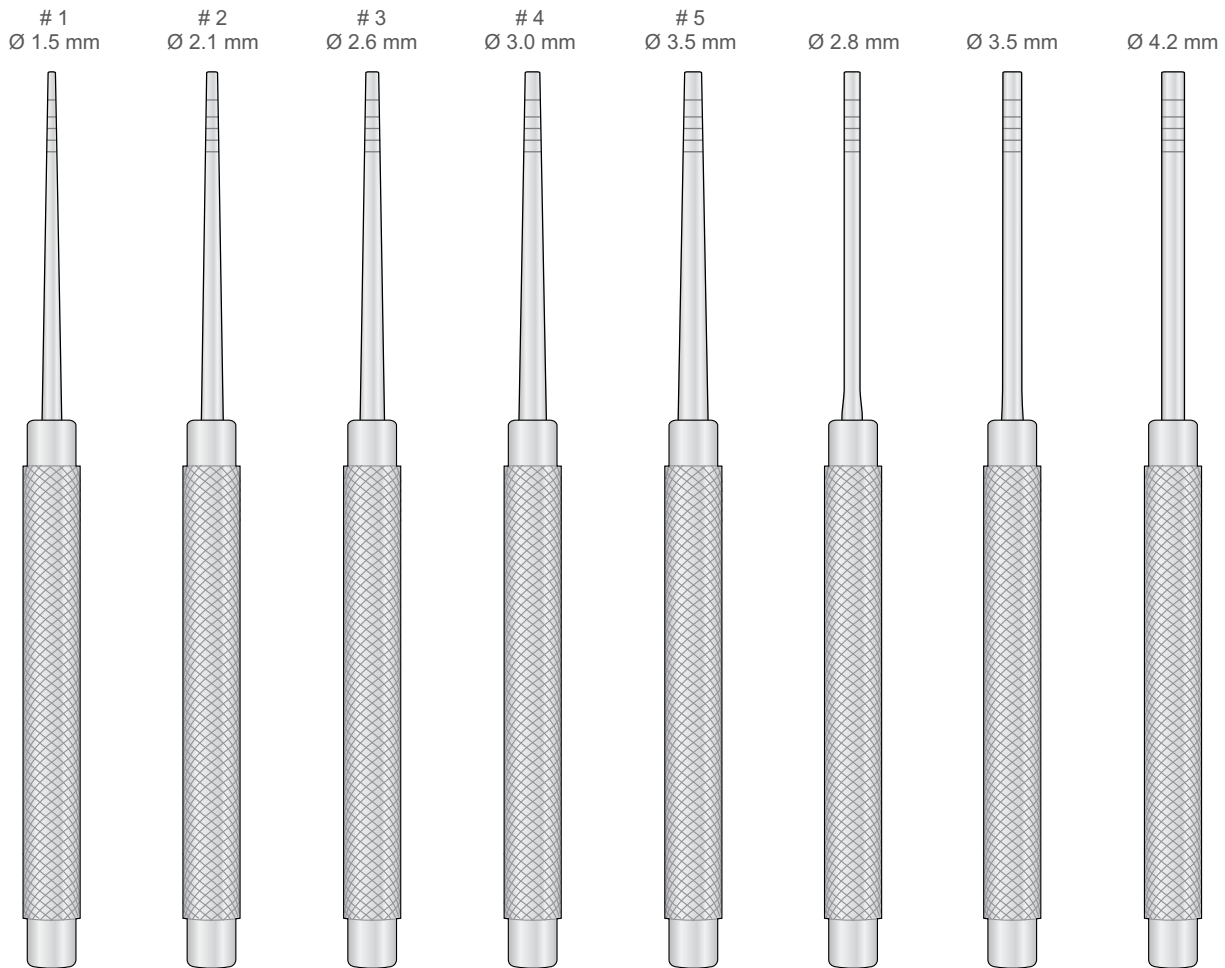


Osteotome  
 Osteotomes  
 Osteotomi  
 Osteótomos  
 Ostéotomes

# 1 Diam.	# 2 Diam.	# 3 Diam.	# 4 Diam.	# 5 Diam.
0 Ø 1.50	0 Ø 2.10	0 Ø 2.60	0 Ø 3.00	0 Ø 3.50
5 Ø 1.90	5 Ø 2.60	5 Ø 3.00	5 Ø 3.50	5 Ø 3.90
8 Ø 2.20	8 Ø 2.80	8 Ø 3.30	8 Ø 3.80	8 Ø 4.20
10 Ø 2.40	10 Ø 3.00	10 Ø 3.50	10 Ø 4.00	10 Ø 4.40
12 Ø 2.60	12 Ø 3.20	12 Ø 3.70	12 Ø 4.20	12 Ø 4.60
14 Ø 2.80	14 Ø 3.40	14 Ø 3.90	14 Ø 4.40	14 Ø 4.80

Straight  
 Gerade  
 Droit  
 Recto  
 Diritto

Bone Pusher



FL-292  
55 mm

FL-293  
155 mm

FL-294  
155 mm

FL-295  
155 mm

FL-296  
155 mm

FL-297  
155 mm

FL-298  
155 mm

FL-299  
155 mm

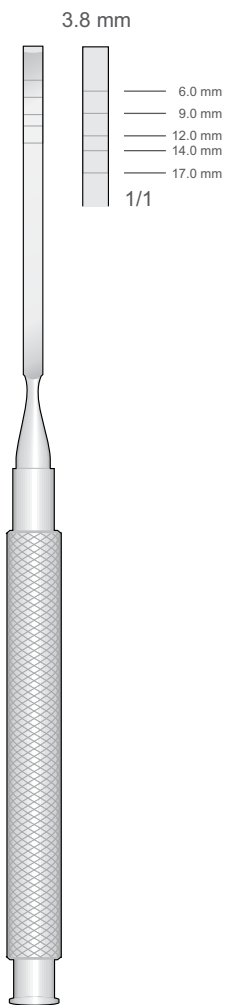
IMPLANTOLOGY



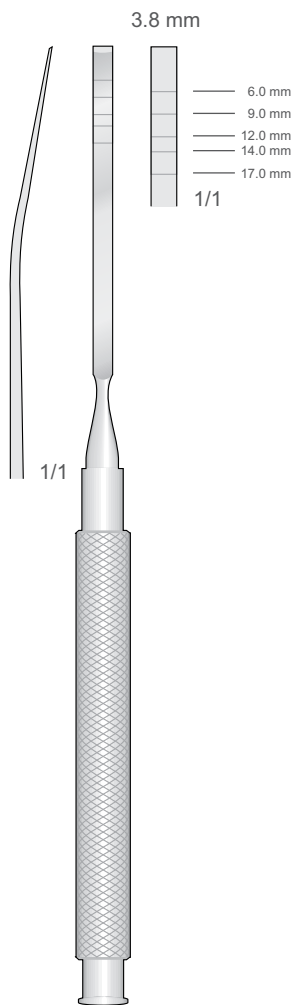
Osteotome  
 Osteotomes  
 Osteotomi  
 Osteótomos  
 Ostéotomes

Meißeln Graduiert  
 Graduated Chisels  
 Scalpelli graduati  
 Cinceles graduados  
 Burins gradués

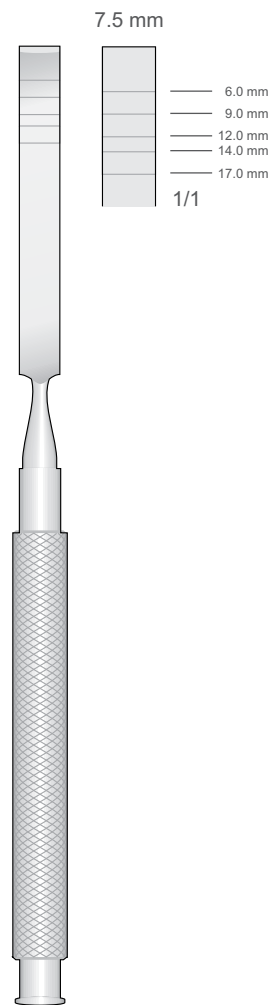
IMPLANTOLOGY



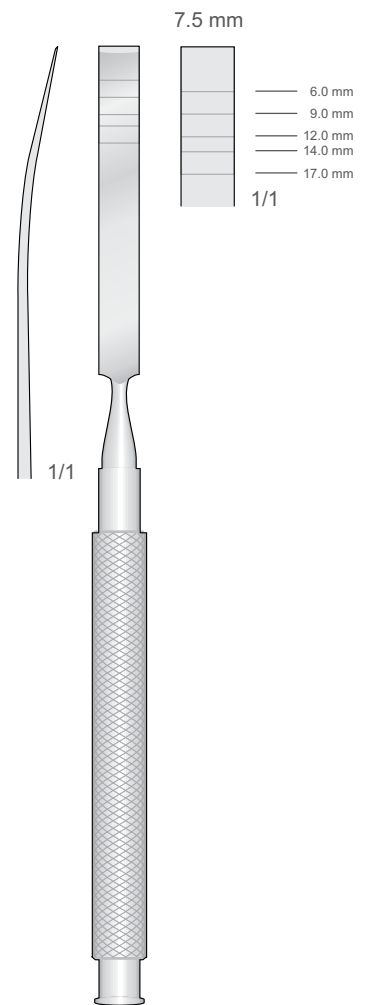
FL-141  
 170 mm



FL-142  
 170 mm



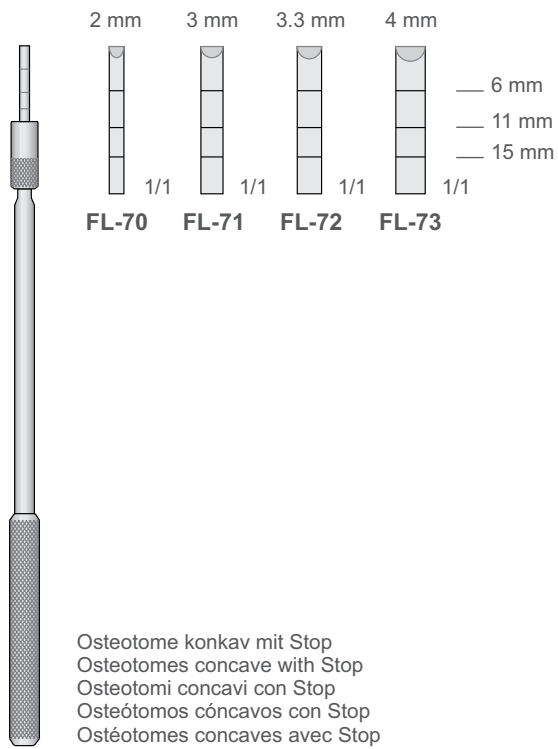
FL-143  
 170 mm



FL-144  
 170 mm

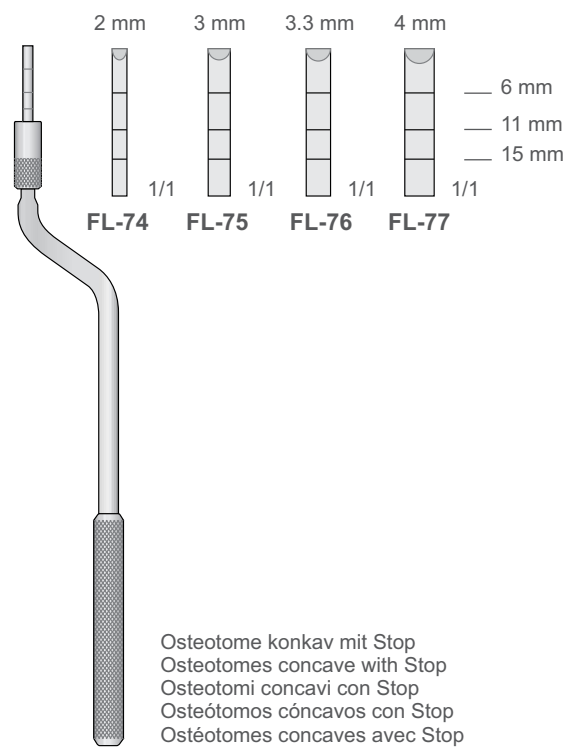


Osteotome  
 Osteotomes  
 Osteotomi  
 Osteótomos  
 Ostéotomes



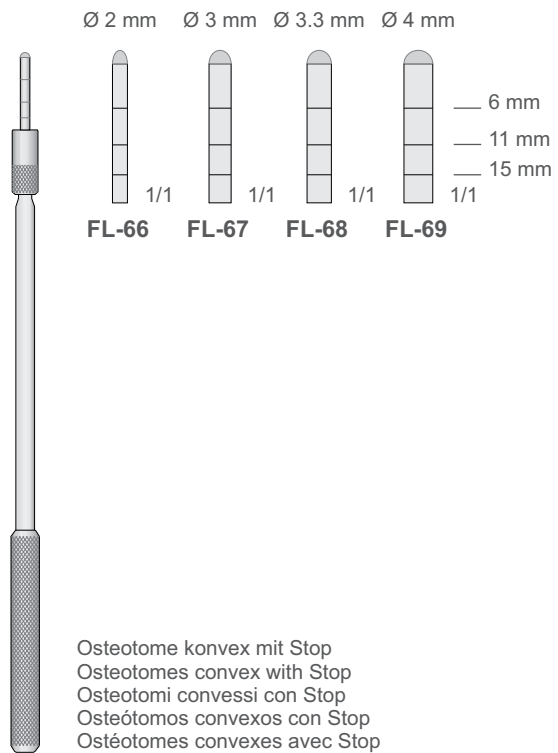
Osteotome konkav mit Stop  
 Osteotomes concave with Stop  
 Osteotomi concavi con Stop  
 Osteótomos cóncavos con Stop  
 Ostéotomes concaves avec Stop

**FL-70/FL-73**  
 165 mm



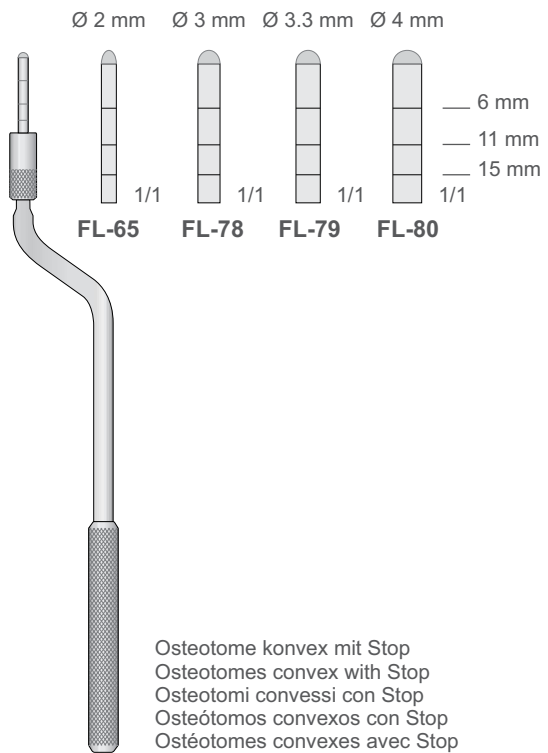
Osteotome konkav mit Stop  
 Osteotomes concave with Stop  
 Osteotomi concavi con Stop  
 Osteótomos cóncavos con Stop  
 Ostéotomes concaves avec Stop

**FL-74/FL-77**  
 165 mm



Osteotome konvex mit Stop  
 Osteotomes convex with Stop  
 Osteotomi convessi con Stop  
 Osteótomos convexos con Stop  
 Ostéotomes convexes avec Stop

**FL-66/FL-69**  
 165 mm



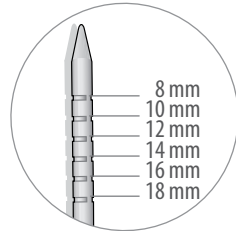
Osteotome konvex mit Stop  
 Osteotomes convex with Stop  
 Osteotomi convessi con Stop  
 Osteótomos convexos con Stop  
 Ostéotomes convexes avec Stop

**FL-65/FL-80**  
 160 mm

IMPLANTOLOGY

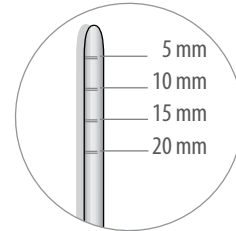


Osteotome  
 Osteotomes  
 Osteotomi  
 Osteótomos  
 Osteótomes



Dilatator  
 Dilator  
 Dilatatori  
 Dilatador  
 Dilatateur

**A-Form**



Spreader  
 Spreader  
 Expansori  
 Expansor  
 Expandeur

**D-Form  
 Convex Tip**

Ø 2 mm



**FL-25**  
 145 mm

Ø 3 mm



**FL-26**  
 145 mm

Ø 3.3 mm



**FL-27**  
 145 mm

Ø 4 mm



**FL-28**  
 145 mm

Ø 3 mm



**FL-37**  
 145 mm

Ø 4 mm



**FL-38**  
 145 mm

Ø 5 mm



**FL-39**  
 145 mm

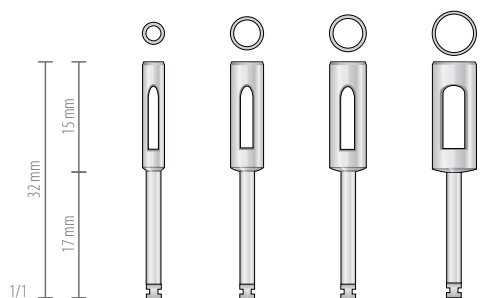
IMPLANTOLOGY



Trepanbohrer  
Trepines  
Trepine  
Trépanos  
Trépan

**For Tissue**  
**Für Gewebe**  
**Pour tissu**  
**Para tejido**  
**Per tessuto**

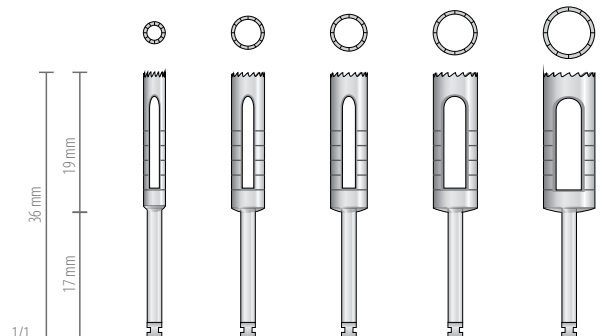
Nicht Gezahnt  
Non Serrated  
No dentellato  
No dentado  
Non dentelé



Ø mm	GA-63	GA-64	GA-65	GA-66
Int.	2.5	4.0	4.5	5.5
Ext.	3.0	4.5	5.0	6.0

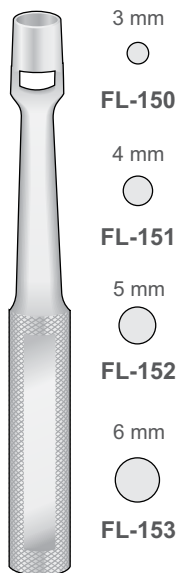
**For Bone**  
**Für Knochen**  
**Pour os**  
**Para hueso**  
**Per osso**

Gezahnt  
Serrated  
Dentellato  
Dentado  
Dentelé

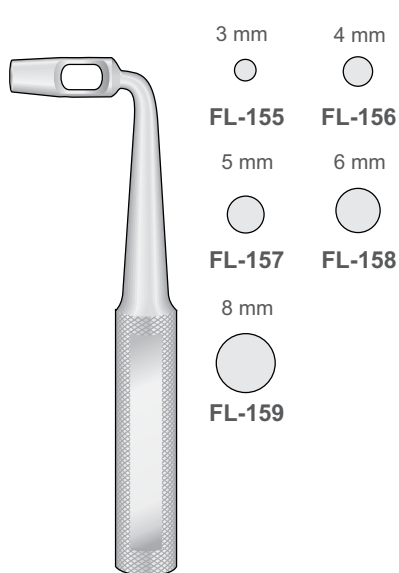


Ø mm	GA-33	GA-34	GA-35	GA-36	GA-37
Int.	2.5	4.0	4.5	5.5	6.5
Ext.	3.0	4.5	5.0	6.0	7.0

Hautstanzen  
Tissue Punches  
Mucotomi Punches  
Bisturi circular para tejido  
Bistouri circulaire pour tissue

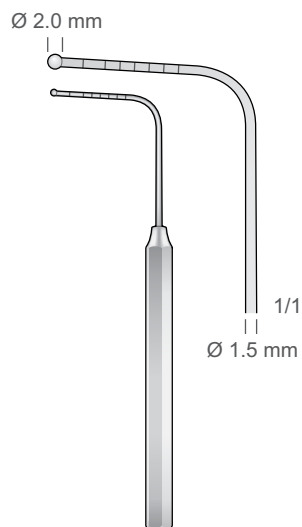


KEYES  
FL-150/FL-153  
100 mm



KEYES  
FL-155/FL-159  
90 mm

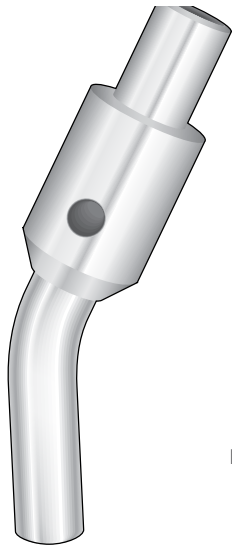
Implant Graduierung  
Implant depth gauge with ball end  
Sonda per controllare la profondità del sito  
Sonda para controlar la profundidad



GA-60  
100 mm

IMPLANTOLOGY

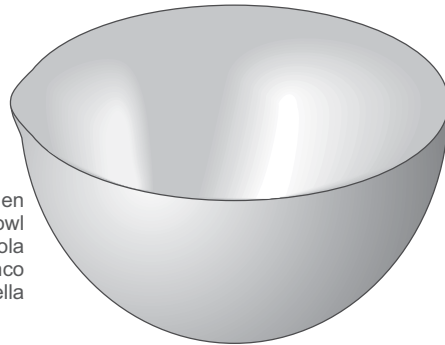




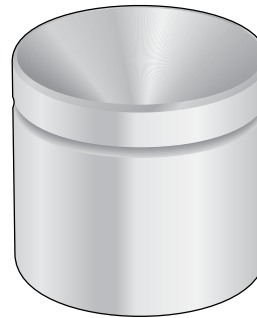
**PELTON-CRANE  
 TS-40**  
 Connection Piece  
 int. Ø 7.5 mm  
 ext. Ø 10.0 mm  
 75 mm

inox Stainless Steel

Schalen  
 Bowl  
 Ciotola  
 Cuenco  
 Bacinella



**CS-01** Ø 40 mm, 15 cc - 0.5 oz  
**CS-02** Ø 60 mm, 75 cc - 2.5 oz  
**CS-03** Ø 80 mm, 225 cc - 7.5 oz  
**CS-04** Ø 100 mm, 325 cc - 11 oz  
**CS-05** Ø 120 mm, 500 cc - 17 oz  
**CS-06** Ø 150 mm, 600 cc - 20 oz



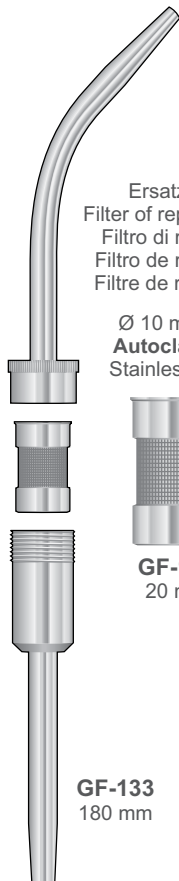
Knochenschale  
 Bone Well  
 Bacinella per osso  
 Cubeta para hueso  
 Cuvette à os  
 Amalgambecher  
 Amalgam Well  
 Mortaio per amalgama  
 Recipiente para amalgama  
 Gobelet pour amalgame

**SS-65**  
 Ø 35x35 mm  
 depth 15 mm  
 5cc - 0.17oz

Absaugkanülen für Knochen mit Filter  
 Suction tube for bone with filter  
 Cannule d'aspirazione con trattenuta osso con filtro  
 Cánulas aspiradoras para hueso con filtro  
 Canule d'aspiration pour os avec filtre

Membranplatzierungsinstrumente  
 Membrane Placement Instruments  
 Strumenti per posizionare membrana  
 Instrumentos para colocar membranas  
 Instruments pour application de membrane

Aufbring Instrument für Knochenmaterial  
 Applicator for bone material  
 Applicatore per materiale osseo  
 Cucharillas para material oseoso  
 Applicateur pour matière osseuse

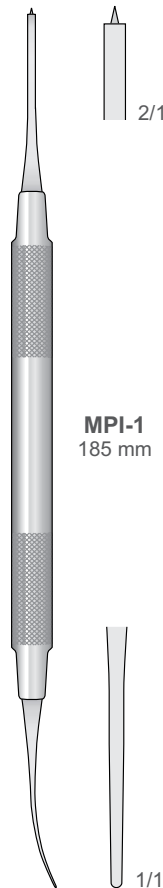


Ersatzfilter  
 Filter of replacement  
 Filtro di ricambio  
 Filtro de recambio  
 Filtre de rechange

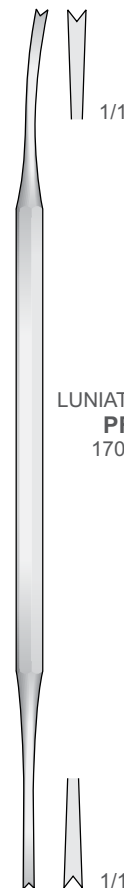
Ø 10 mm int.  
**Autoclavable**  
 Stainless Steel

**GF-134**  
 20 mm

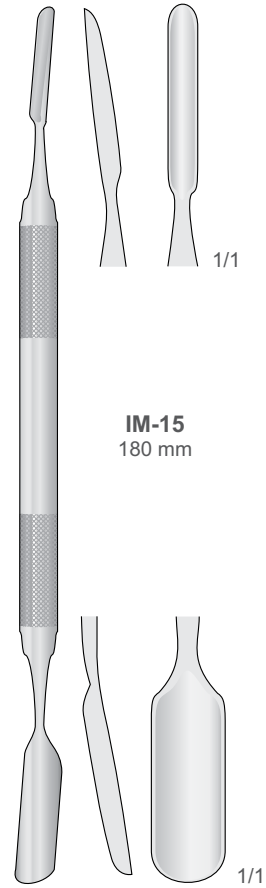
**GF-133**  
 180 mm



**MPI-1**  
 185 mm



**LUNIATSCHEK  
 PF-6**  
 170 mm



**IM-15**  
 180 mm



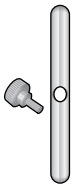
Knochenmühlen - und spritzen  
 Bone Mills and Syringes  
 Macina e siringhe per osso  
 Molinos y jeringas para hueso  
 Moulins et seringues à os



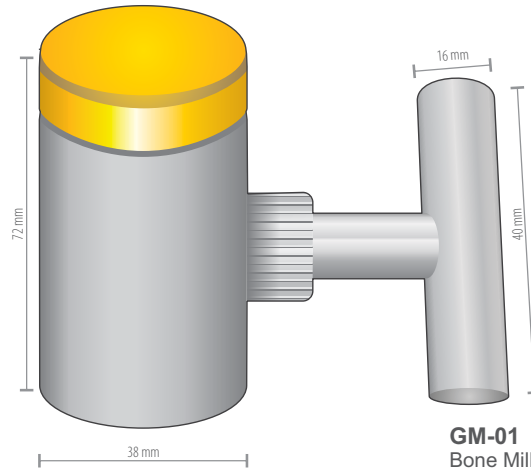
**GA-18**  
 Lower  
 Titanium



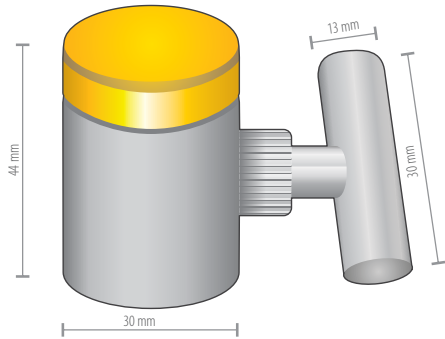
**GA-17**  
 Upper  
 Titanium



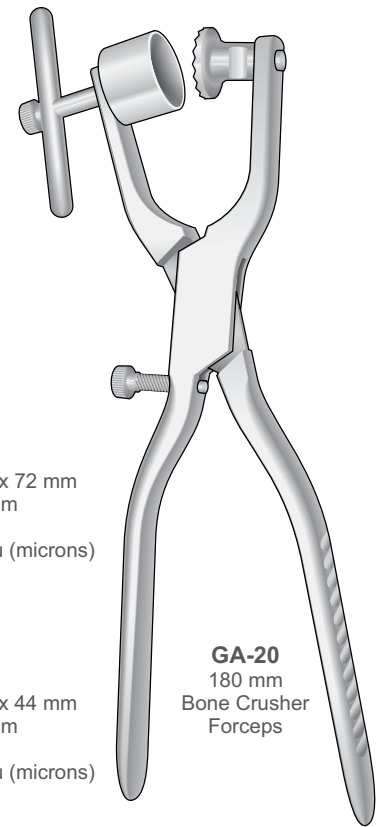
**GA-19**  
 Handle  
 with screw



**GM-01**  
 Bone Mill / Large  
 Dimensions: Ø 38 x 72 mm  
 Mill hole: Ø 0.71 mm  
 Volume: 2 cc.  
 Particle size: 710 µ (microns)

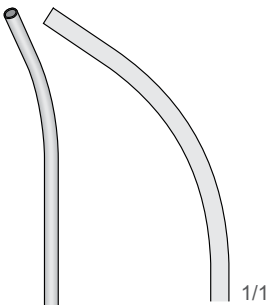


**GM-02**  
 Bone Mill / Small  
 Dimensions: Ø 30 x 44 mm  
 Mill hole :Ø 0.65 mm  
 Volume: 1 cc.  
 Particle size: 650 µ (microns)



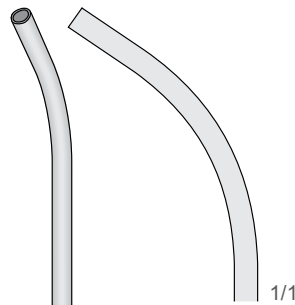
**GA-20**  
 180 mm  
 Bone Crusher  
 Forceps

Ø int. 2.5 mm  
 Ø ext. 3.5 mm



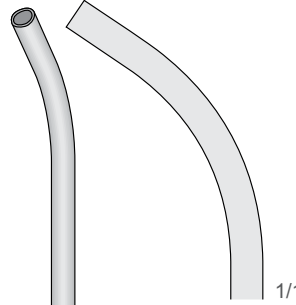
**SS-60M**  
 160 mm

Ø int. 3.5 mm  
 Ø ext. 4.5 mm



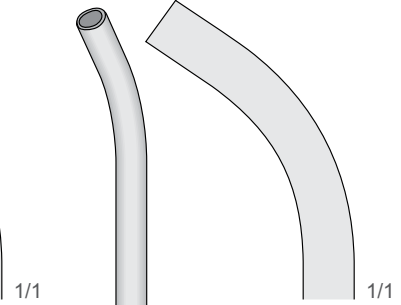
**SS-61M**  
 160 mm

Ø int. 4.4 mm  
 Ø ext. 5.5 mm



**SS-62M**  
 160 mm

Ø int. 6 mm  
 Ø ext. 7 mm

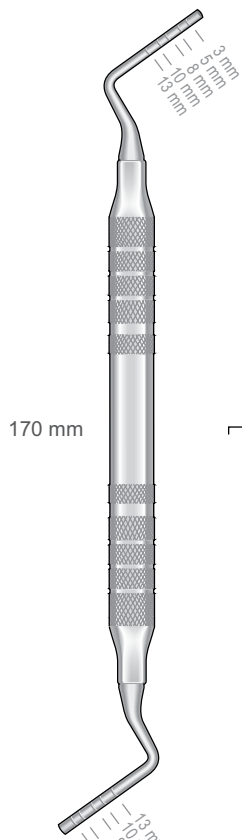


**SS-64M**  
 160 mm

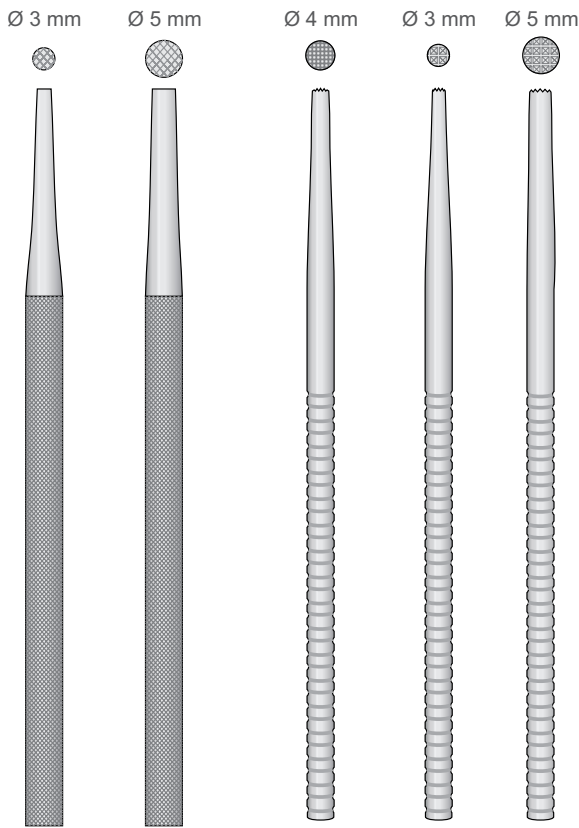
IMPLANTOLOGY



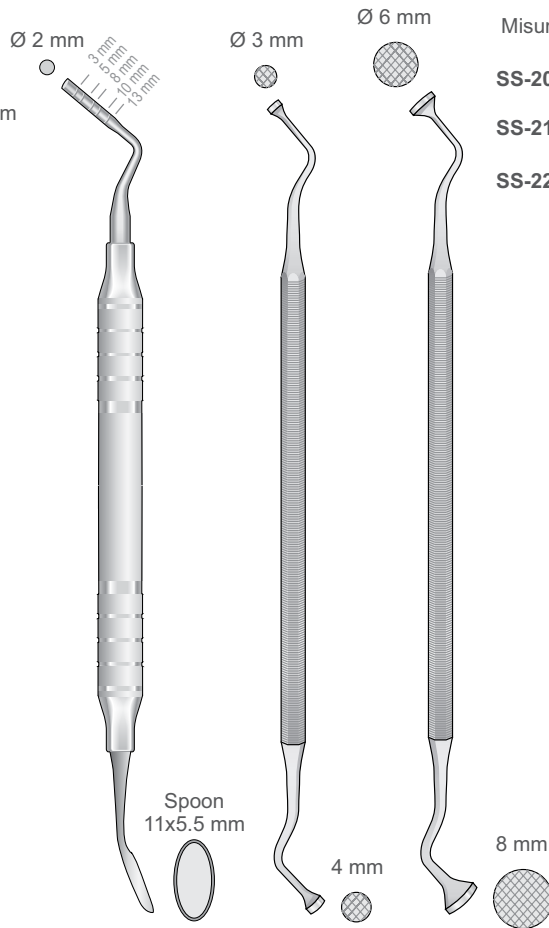
Knochenstopfer  
 Bone Tampers - Bone Grafting Packers  
 Compattatore per osso  
 Compactador para hueso  
 Compacteur à os



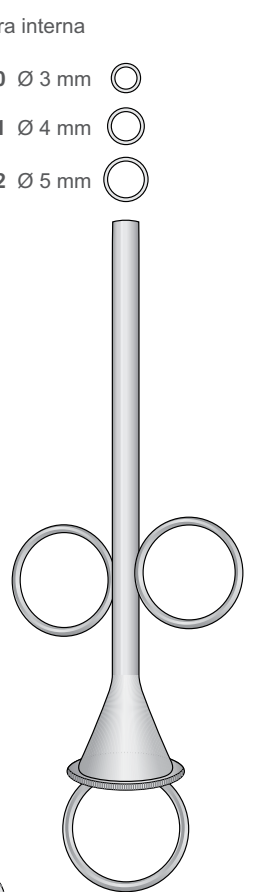
	Non Serrated Tips		Serrated Tips	
<b>USB-P1</b>	○ Ø 1.8	○ Ø 2.8	● Ø 1.8	● Ø 2.8
<b>USB-P2</b>	○ Ø 3.2	○ Ø 3.8	● Ø 3.2	● Ø 3.8
<b>USB-P3</b>	○ Ø 4.2	○ Ø 4.8	● Ø 4.2	● Ø 4.8
<b>USB-P4</b>	○ Ø 5.0	○ Ø 5.5	● Ø 5.0	● Ø 5.5



**FL-20** 155 mm  
**FL-21** 155 mm  
**FL-31** 155 mm  
**FL-33** 155 mm  
**FL-35** 155 mm



**OP-6** 175 mm  
**OP-7** 170 mm  
**OP-8** 170 mm



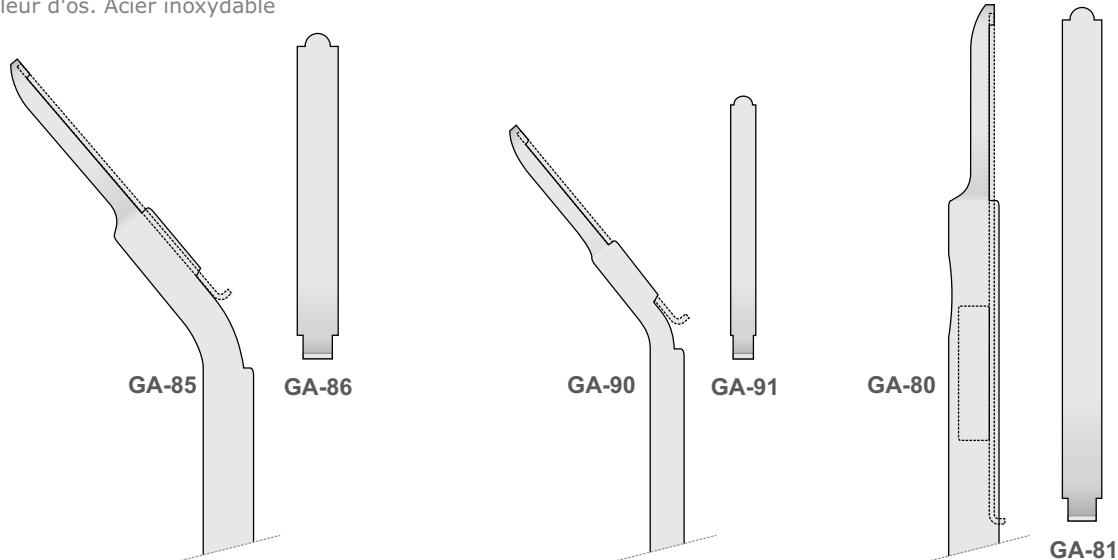
**FOITZIK**  
**SS-20/SS-22**  
 140 mm

IMPLANTOLOGY

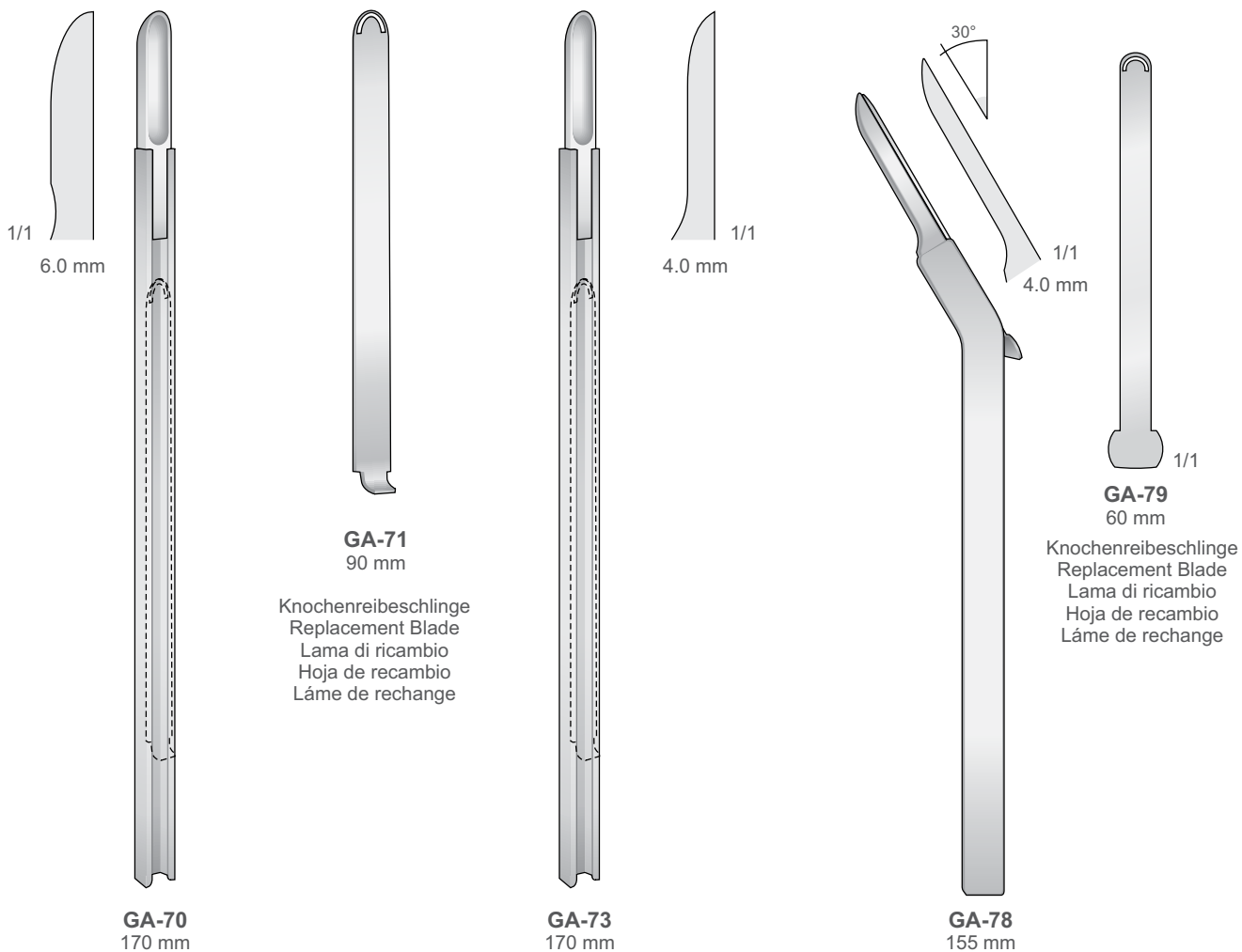




Knochenschaber. Rostfrei Stahl  
 Bone-Grafter. Stainless Steel  
 Grattini per osso. Inox  
 Raspador de hueso. Acero inoxidable  
 Racleur d'os. Acier inoxydable



Knochenschaber mit Reibeklinge  
 Bone-Grafter with blade  
 Grattino con lama  
 Raspador de hueso con hoja  
 Racleur d'os avec lame



IMPLANTOLOGY



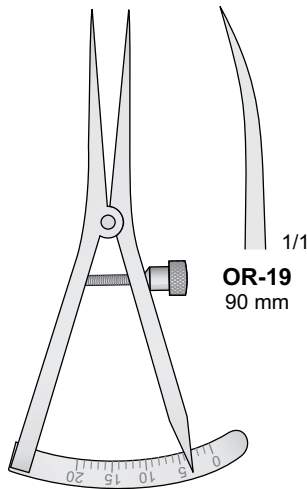


**LS-09**  
200 mm



**LS-08**  
100 mm

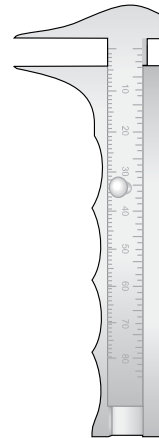
Meßbereich: 0 - 20 mm  
 Measuring range: 0 - 20 mm  
 Campo di misura: 0 - 20 mm  
 Alcance de medición: 0 - 20 mm  
 Etendue de mesure: 0 - 20 mm



**OR-19**  
CASTROVIEJO  
90 mm



**OR-40**  
125 mm

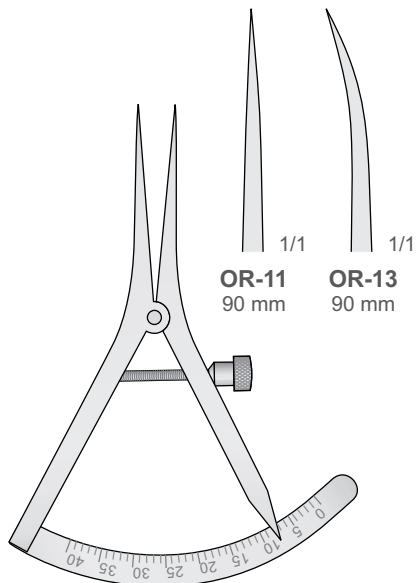


**OR-45**  
95 mm

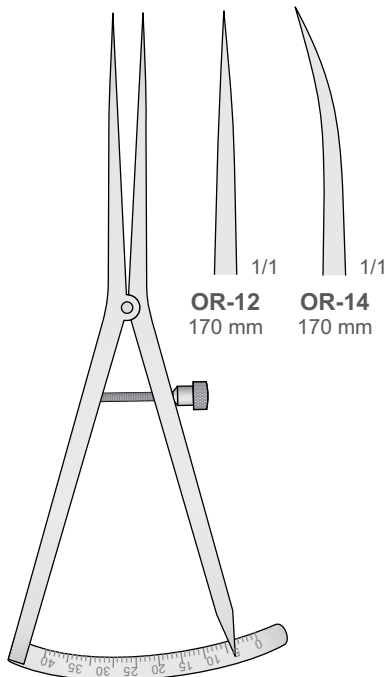
Meßbereich: 0 - 80 mm  
 Measuring range: 0 - 80 mm  
 Campo di misura: 0 - 80 mm  
 Alcance de medición: 0 - 80 mm  
 Etendue de mesure: 0 - 80 mm

0 - 40 mm  
 Meßbereich / Measuring range / Campo di misura  
 Alcance de medición / Etendue de mesure

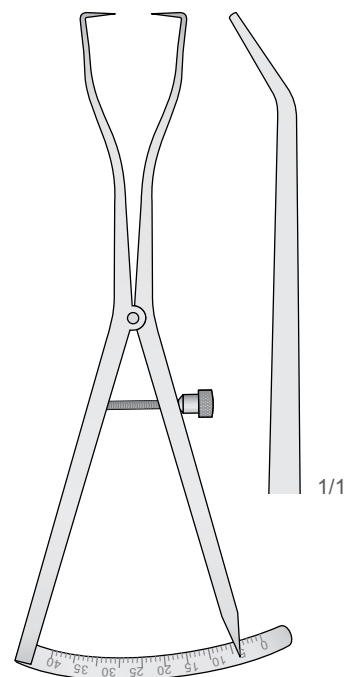
IMPLANTOLOGY



CASTROVIEJO  
**OR-11/OR-13**  
90 mm



CASTROVIEJO  
**OR-12/OR-14**  
170 mm

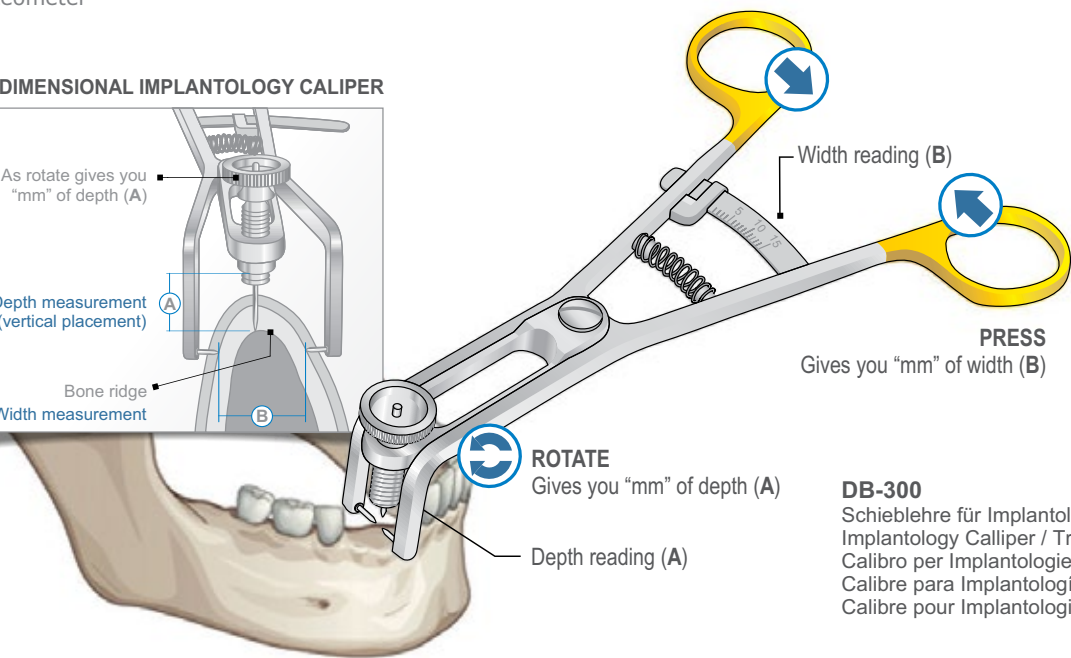
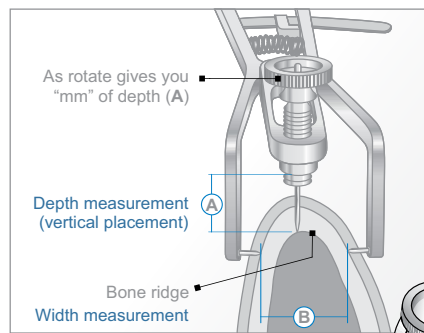


CASTROVIEJO  
**OR-18**  
170 mm



Osteometer  
 Osteometer  
 Osteometro  
 Osteometro  
 Osteometer

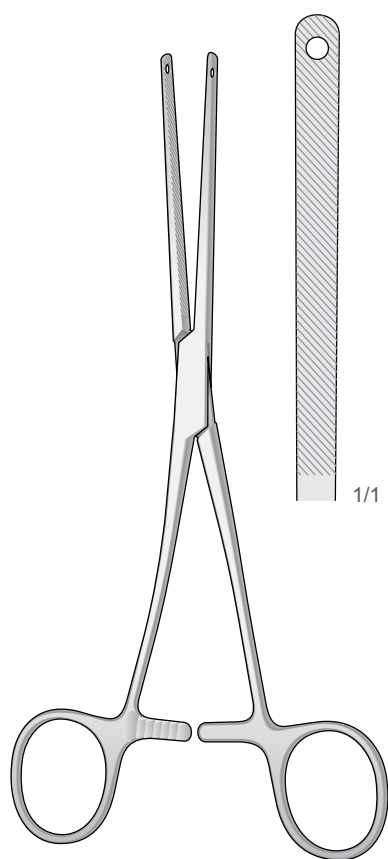
**TRIDIMENSIONAL IMPLANTOLOGY CALIPER**



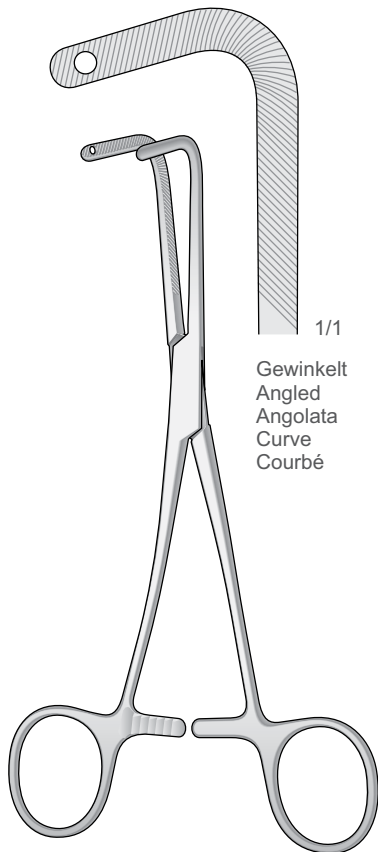
**DB-300**  
 Schiebellehre für Implantologie / Drei-Dimensional  
 Implantology Calliper / Tridimensional  
 Calibro per Implantologie / Tridimensionale  
 Calibre para Implantología / Tridimensional  
 Calibre pour Implantologie / Tridimensionnel

**BONE BLOCK CLAMP**

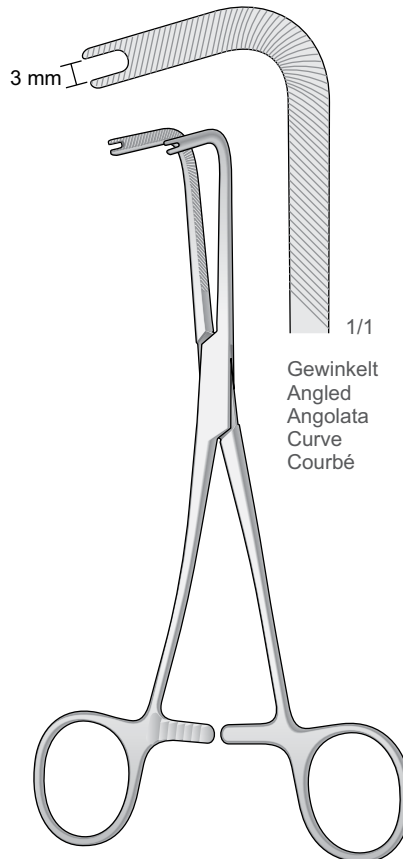
Bone Holding Clamps / Knochenhalteklammern / Daviers à os  
 Pinzas de sujeción para hueso / Pinze per fissare l'osso



**P-340**  
 220 mm



**P-341**  
 200 mm



**P-342**  
 200 mm

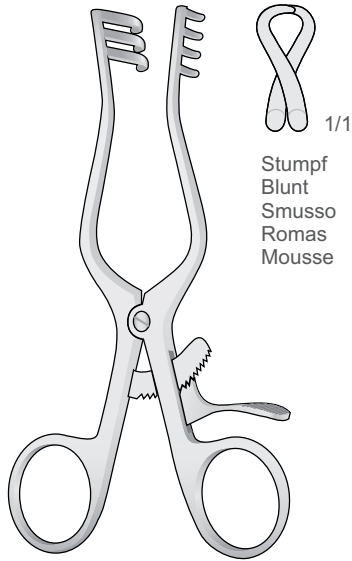
Gewinkelt  
 Angled  
 Angolata  
 Curve  
 Courbé

**IMPLANTOLOGY**

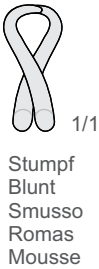


Retraktoren - Knochenhaltezange  
 Retractors - Bone Holding Forceps  
 Divaricatori - Pinza per fissare l'osso  
 Separadores - Pinzas para sujeción para hueso  
 Écarteurs - Daviers à os

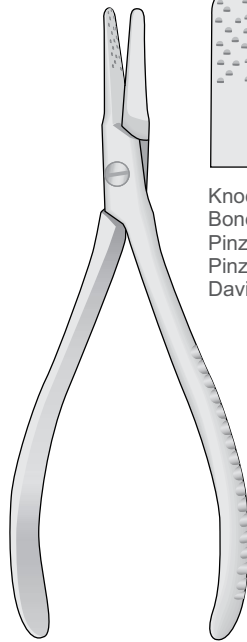
Tibia Wundspreizer  
 Tibial and Iliac Retractor  
 Divaricatore per tibia e cresta iliaca  
 Separadores tibiales e iliacos  
 Écarteur pour tibia e crête iliaque



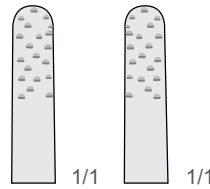
**WEITLANER**  
**BV-23**  
 165 mm



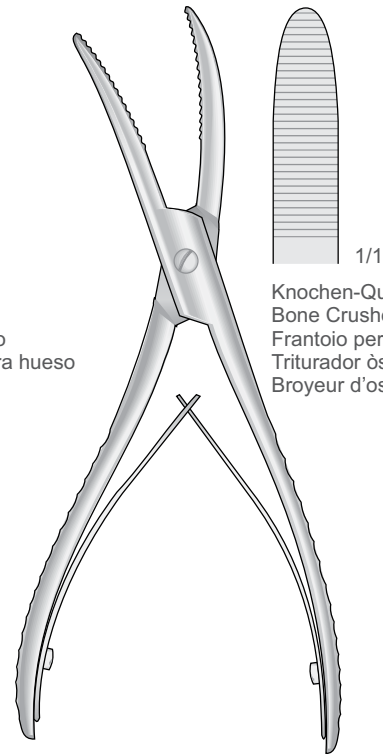
Stumpf  
 Blunt  
 Smusso  
 Romas  
 Mousse



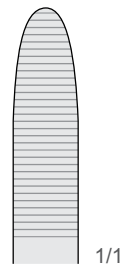
**RADOLF**  
**FO-159**  
 135 mm



Knochenhaltezange  
 Bone Holding Forceps  
 Pinza per fissare l'osso  
 Pinzas de sujeción para hueso  
 Davier à os

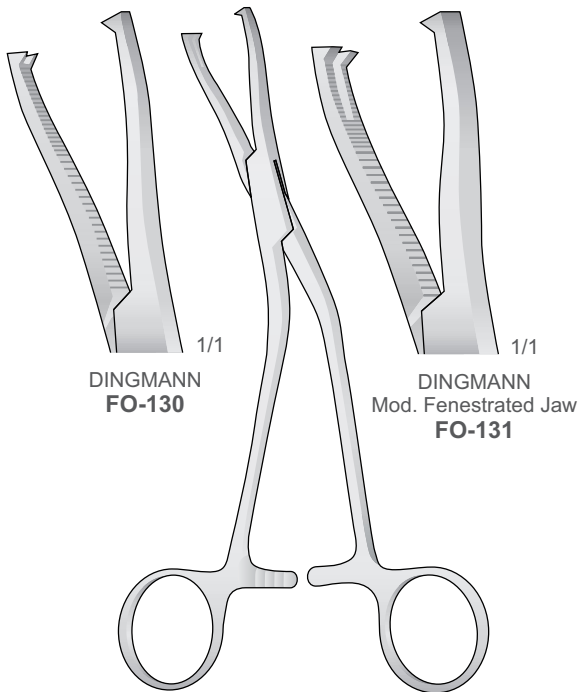


**WOLFF**  
**LX-113**  
 180 mm



Knochen-Quetsche  
 Bone Crusher  
 Frantoio per osso  
 Triturador óseo  
 Broyeur d'os

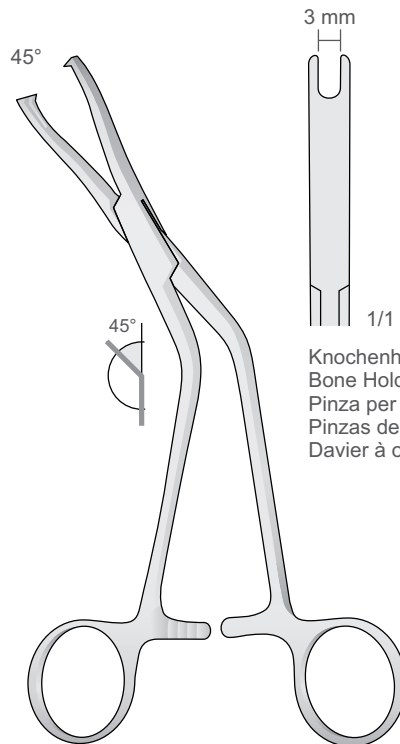
IMPLANTOLOGY



**DINGMANN**  
**FO-130**

**DINGMANN**  
 Mod. Fenestrated Jaw  
**FO-131**

**DINGMANN**  
**FO-130/FO-131**  
 190 mm



**DINGMANN - Mod. Fenestrated Jaw**  
**FO-131S**  
 190 mm





we take a closer look

# + PERIOSTEALS / CURETTES / BONE

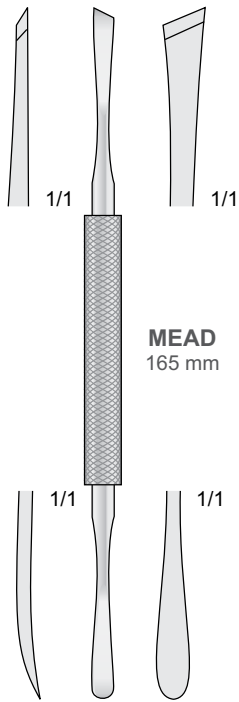


Periosteal Elevators  
Curettes  
Bone Files  
Tissue Nippers  
Bone Rongeurs  
Bone Cutting Forceps

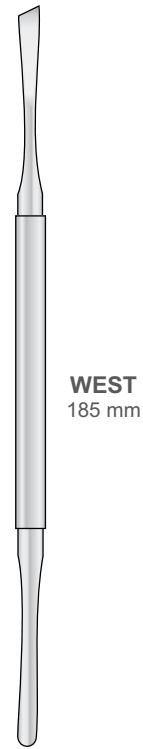
PERIOSTEALS  
CURETTES &  
BONE



Raspatorien  
 Periosteals (Raspatories)  
 Scollaperiosteï (Periostotomi)  
 Periostótomos (Legras)  
 Rugines périostiques



**MEAD**  
165 mm

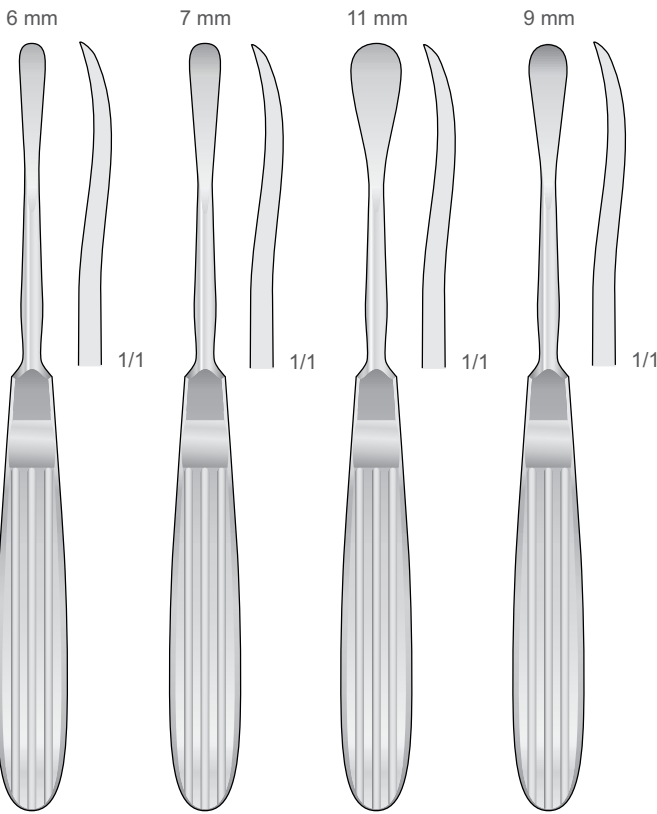


**WEST**  
185 mm

**PERIOSTEAL  
ELEVATORS**

**PERIOSTEAL  
RASPATORIES**

Scharf - Sharp - Taglienti - Cortante - Tranchant

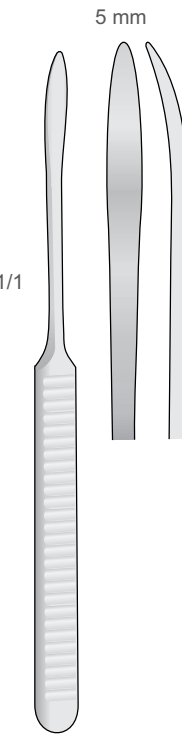


**OBWEGESER  
DO-59**  
175 mm

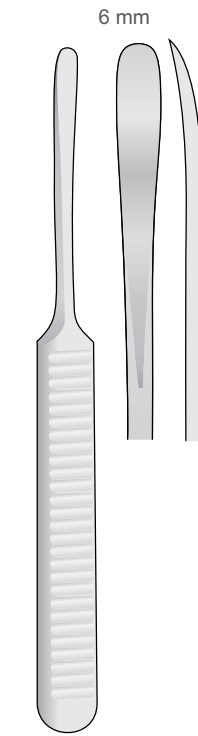
**OBWEGESER  
DO-63**  
175 mm

**OBWEGESER  
DO-65**  
175 mm

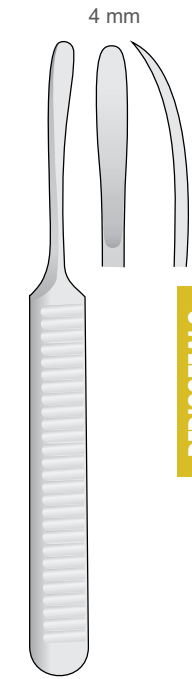
**OBWEGESER  
DO-67**  
175 mm



**WILLIGER  
WG-10**  
165 mm



**WILLIGER  
WG-12**  
160 mm

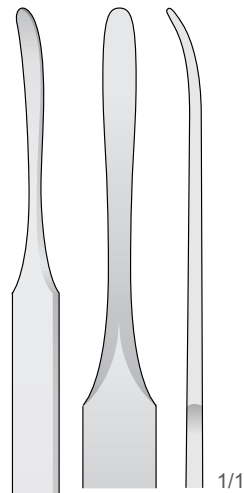


**WILLIGER  
WG-14**  
140 mm

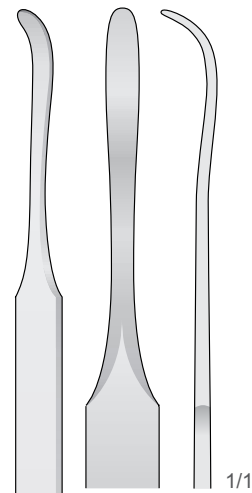
**PERIOSTEALS  
CURETTES &  
BONE**



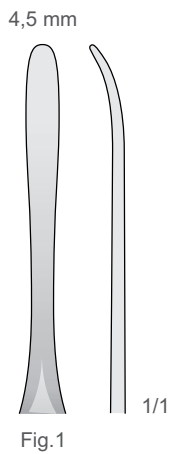
Raspatorien  
 Periosteals (Raspatories)  
 Scollaperiosteai (Periostotomi)  
 Periostótomos (Legras)  
 Rugines périostiques



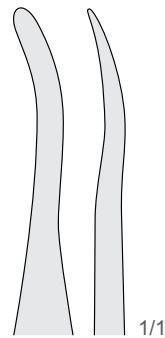
**KÖNIG  
 KO-1**  
 155 mm



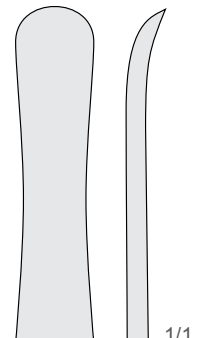
**KÖNIG  
 KO-2**  
 155 mm



**KÖNIG  
 KO-3**  
 210 mm



**SELDIN  
 KO-22**  
 190 mm



**SELDIN  
 KO-23**  
 195 mm

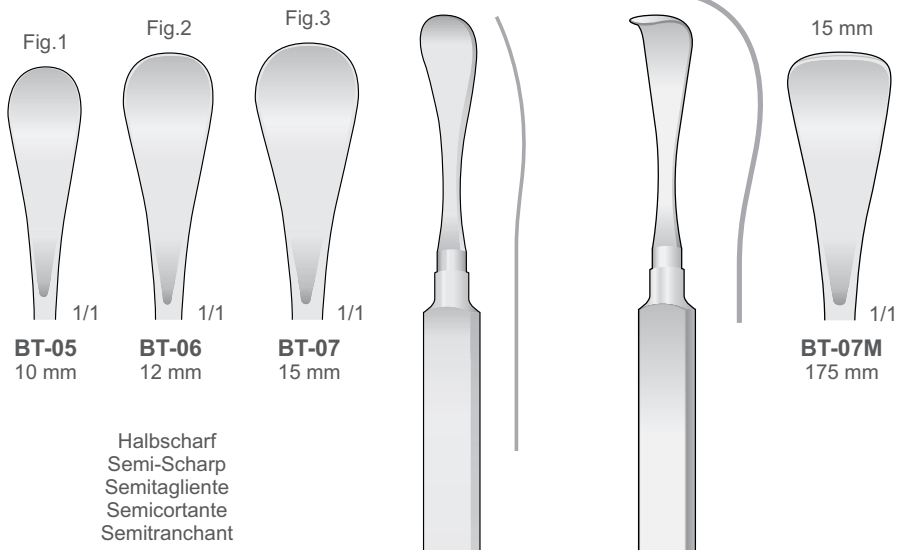


PERIOSTEALS  
 CURETTES &  
 BONE



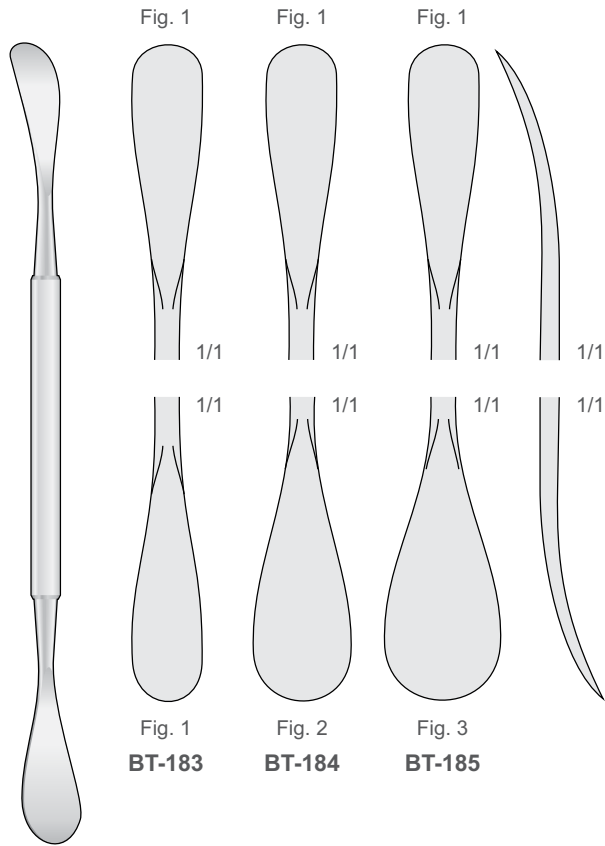


Raspatorien - Elevatorien  
 Raspatories - Elevators  
 Periostotomi - Elevatori  
 Legras - Elevadores  
 Rugines - Elevateurs

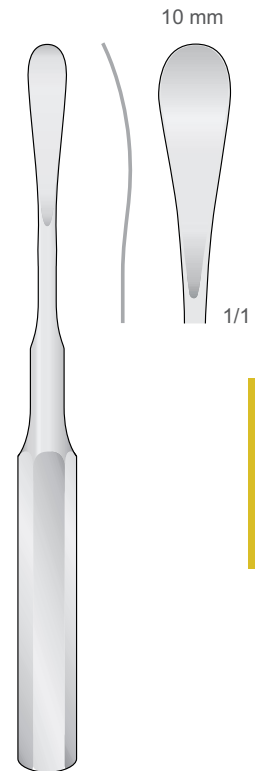


HENAHAN  
BT-05/BT-07  
175 mm

HENAHAN  
BT-07M  
175 mm



HENAHAN  
BT-183/BT-185  
200 mm



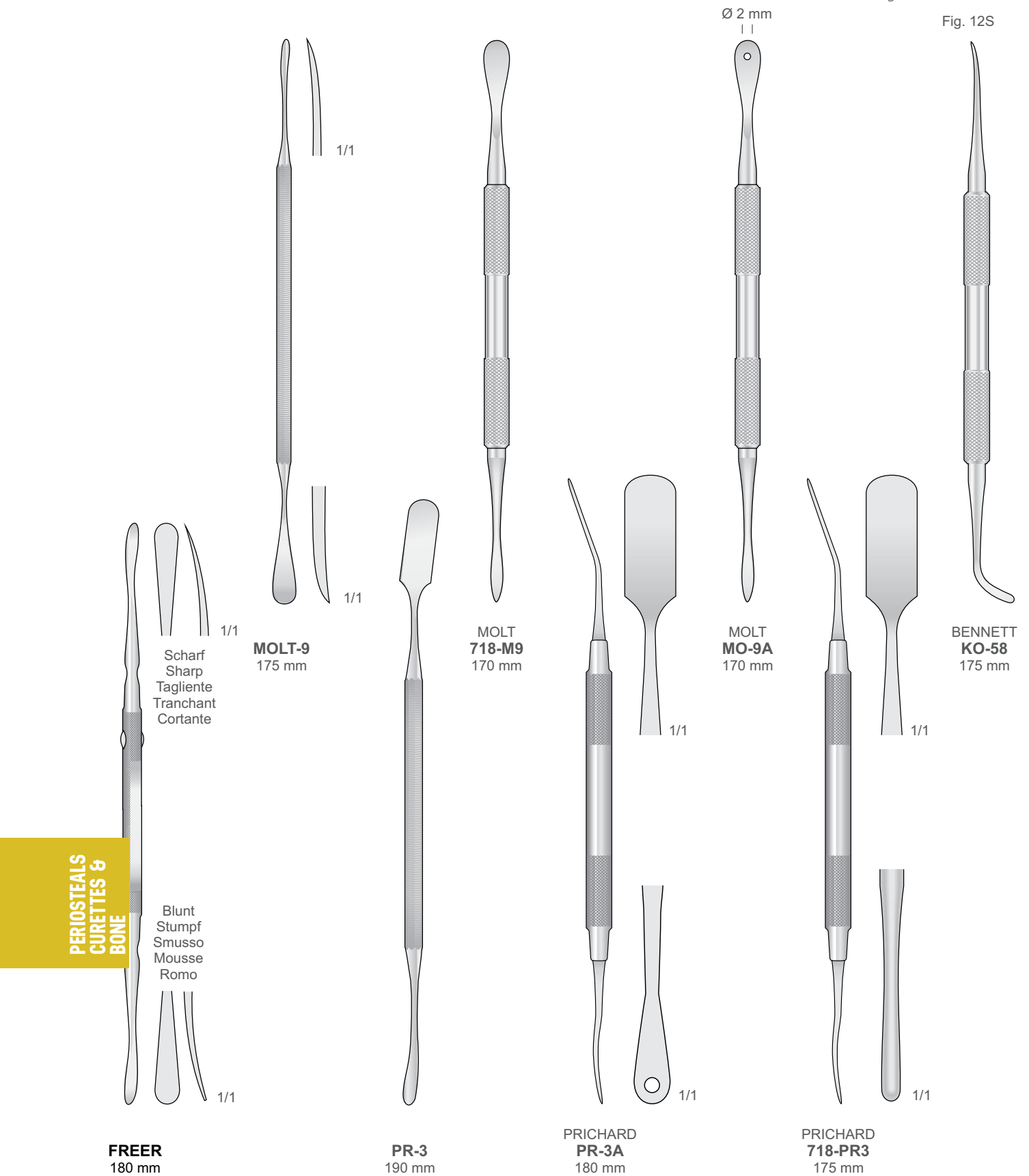
MOLT  
MO-15  
160 mm

PERIOSTEALS  
CURETTES &  
BONE

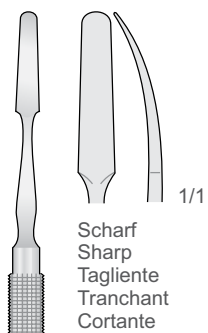


Raspatorien - Elevatorien  
 Raspatories - Elevators  
 Periostotomi - Elevatori  
 Legras - Elevadores  
 Rugines - Elevateurs

Fig. 12S

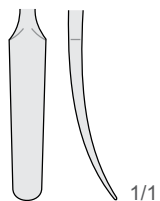


Raspatorien - Elevatorien  
 Raspatories - Elevators  
 Periostotomi - Elevatori  
 Legras - Elevadores  
 Rugines - Elevateurs



Scharf  
 Sharp  
 Tagliente  
 Tranchant  
 Cortante

Stumpf  
 Blunt  
 Smusso  
 Mousse  
 Romo

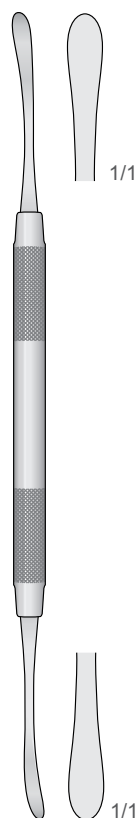


**KILIAN  
 KO-11**  
 180 mm

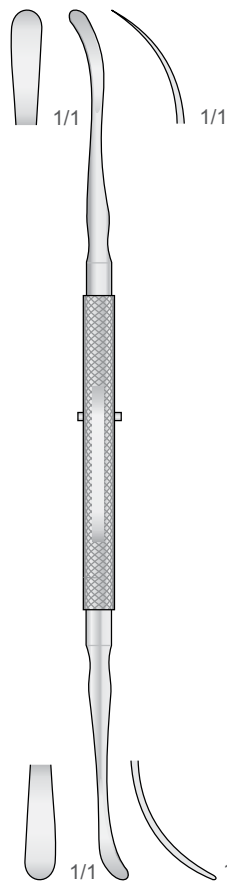


**MO-20**  
 200 mm

Fig. 14



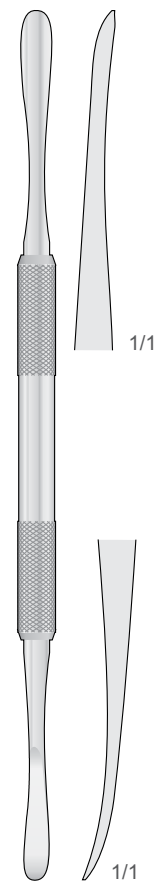
**GOLDMAN-FOX  
 718-GF14**  
 165 mm



**ROGER  
 KO-66**  
 180 mm



**MENEGHINI  
 MO-24**  
 180 mm



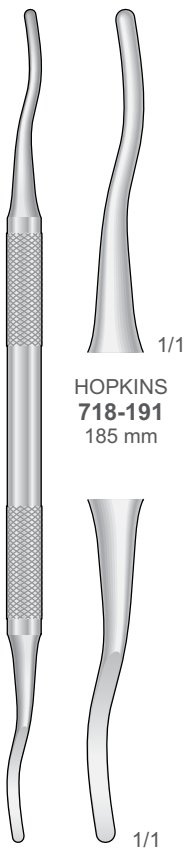
**718-M8**  
 185 mm



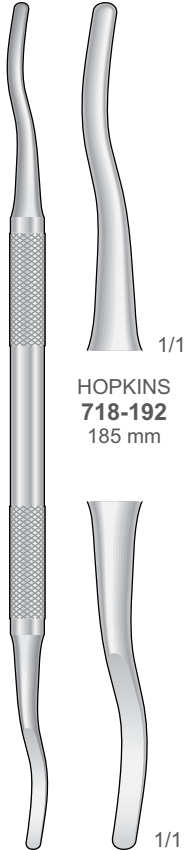
**PERIOSTEALS  
 CURETTES &  
 BONE**



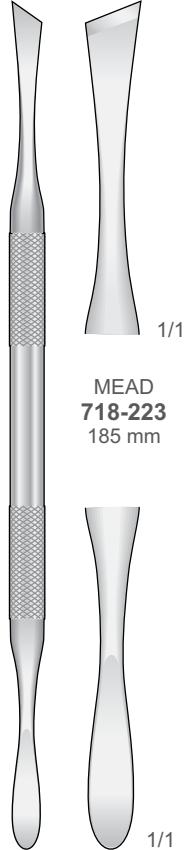
Raspatorien - Elevatorien  
 Raspatories - Elevators  
 Periostotomi - Elevatori  
 Legras - Elevadores  
 Rugines - Elevateurs



**HOPKINS  
718-191**  
185 mm

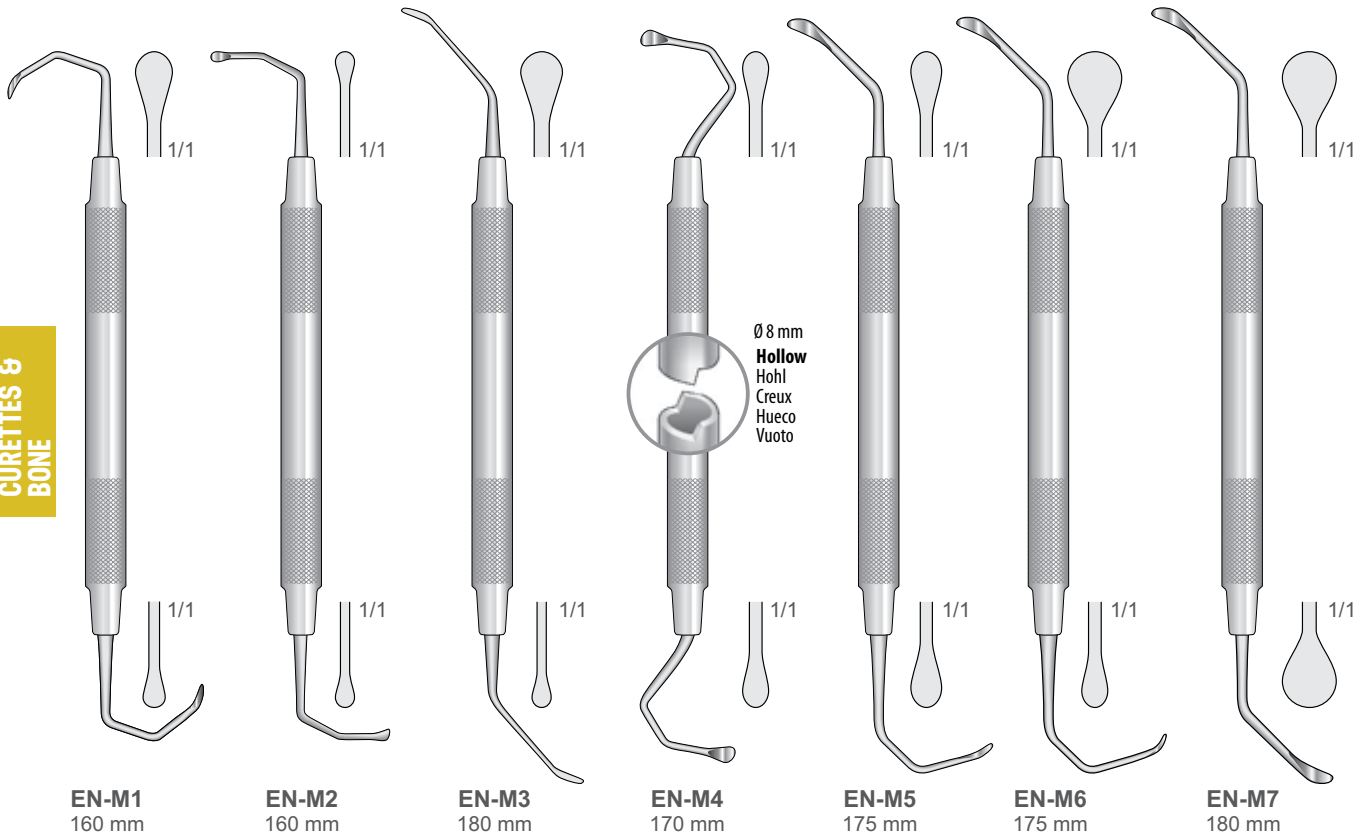


**HOPKINS  
718-192**  
185 mm



**MEAD  
718-223**  
185 mm

Instrumente für Sinuslift / Sinus Lift Instruments / Strumenti per rialzo del seno  
 Instrumentos para elevación de seno maxilar / Instruments d'élévation sinusienne



**PERIOSTEALS  
CURETTES &  
BONE**

Ø 8 mm  
**Hollow**  
 Hohl  
 Creux  
 Hueco  
 Vuoto

**EN-M1**  
160 mm

**EN-M2**  
160 mm

**EN-M3**  
180 mm

**EN-M4**  
170 mm

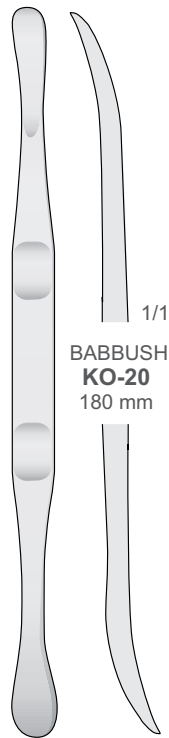
**EN-M5**  
175 mm

**EN-M6**  
175 mm

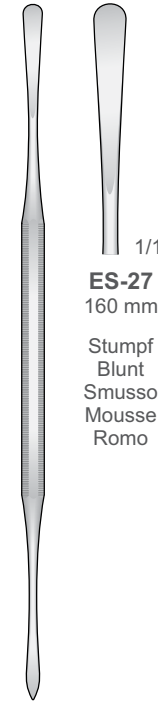
**EN-M7**  
180 mm



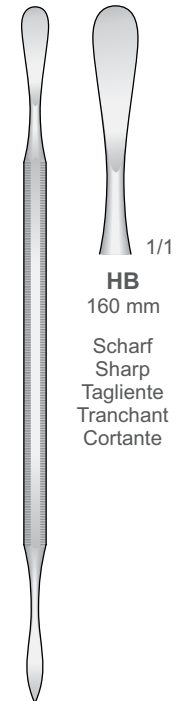
Raspatorien - Elevatorien  
 Raspatories - Elevators  
 Periostotomi - Elevatori  
 Legras - Elevadores  
 Rugines - Elevateurs



BABBUSH  
**KO-20**  
 180 mm



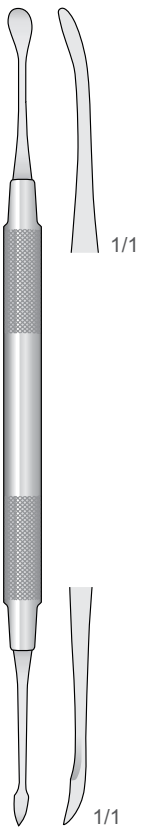
**ES-27**  
 160 mm  
 Stumpf  
 Blunt  
 Smusso  
 Mousse  
 Romo



**HB**  
 160 mm  
 Scharf  
 Sharp  
 Tagliente  
 Tranchant  
 Cortante

Instrumente für Sinuslift  
 Sinus Lift Instruments  
 Strumenti per rialzo del seno  
 Instrumentos para elevación de seno maxilar  
 Instruments d'élévation sinusienne

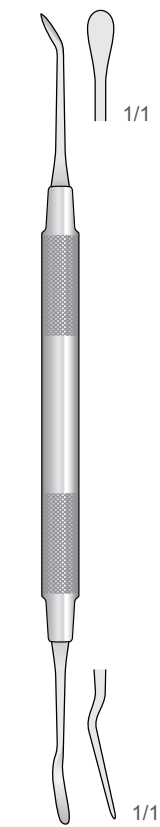
Fig. 24G



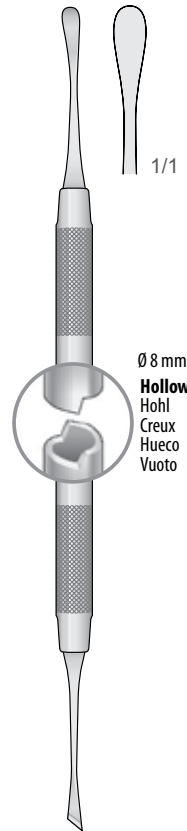
**MOLT  
 MO-8**  
 180 mm



**SURGICAL WOODSON  
 MIR-08**  
 175 mm

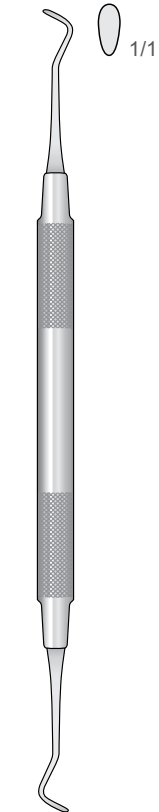


**WOODSON  
 712-241**  
 170 mm

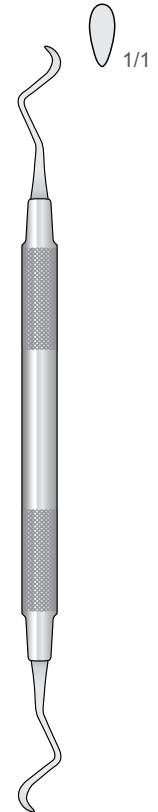


**718-24G**  
 175 mm

Ø 8 mm  
 Hollow  
 Hohl  
 Creux  
 Hueco  
 Vuoto



**718-EN1**  
 175 mm



**718-EN2**  
 165 mm

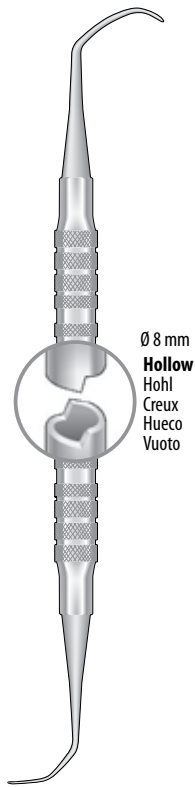


**718-EN3**  
 170 mm

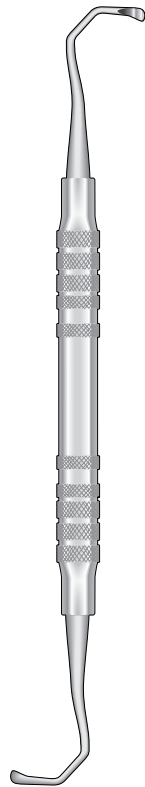
PERIOSTEALS  
 CURETTES &  
 BONE



Raspatorien - Elevatorien  
 Raspatories - Elevators  
 Periostotomi - Elevatori  
 Legras - Elevadores  
 Rugines - Elevateurs



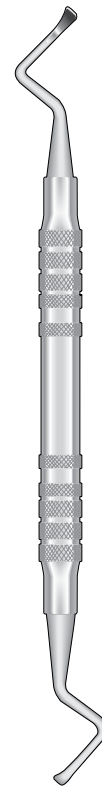
TASO-1



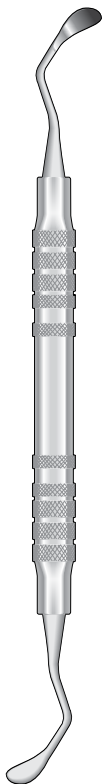
TASO-2



TASO-3



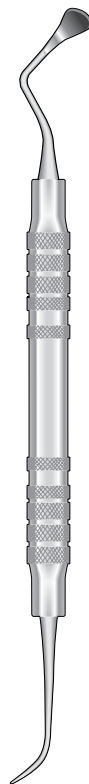
TASO-4



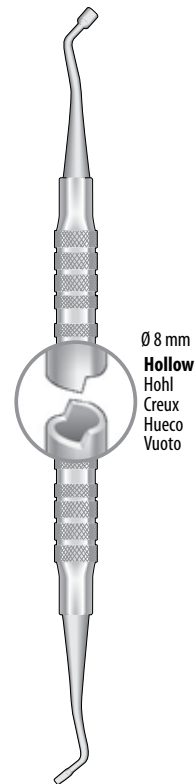
TASO-5



TASO-6



TASO-7



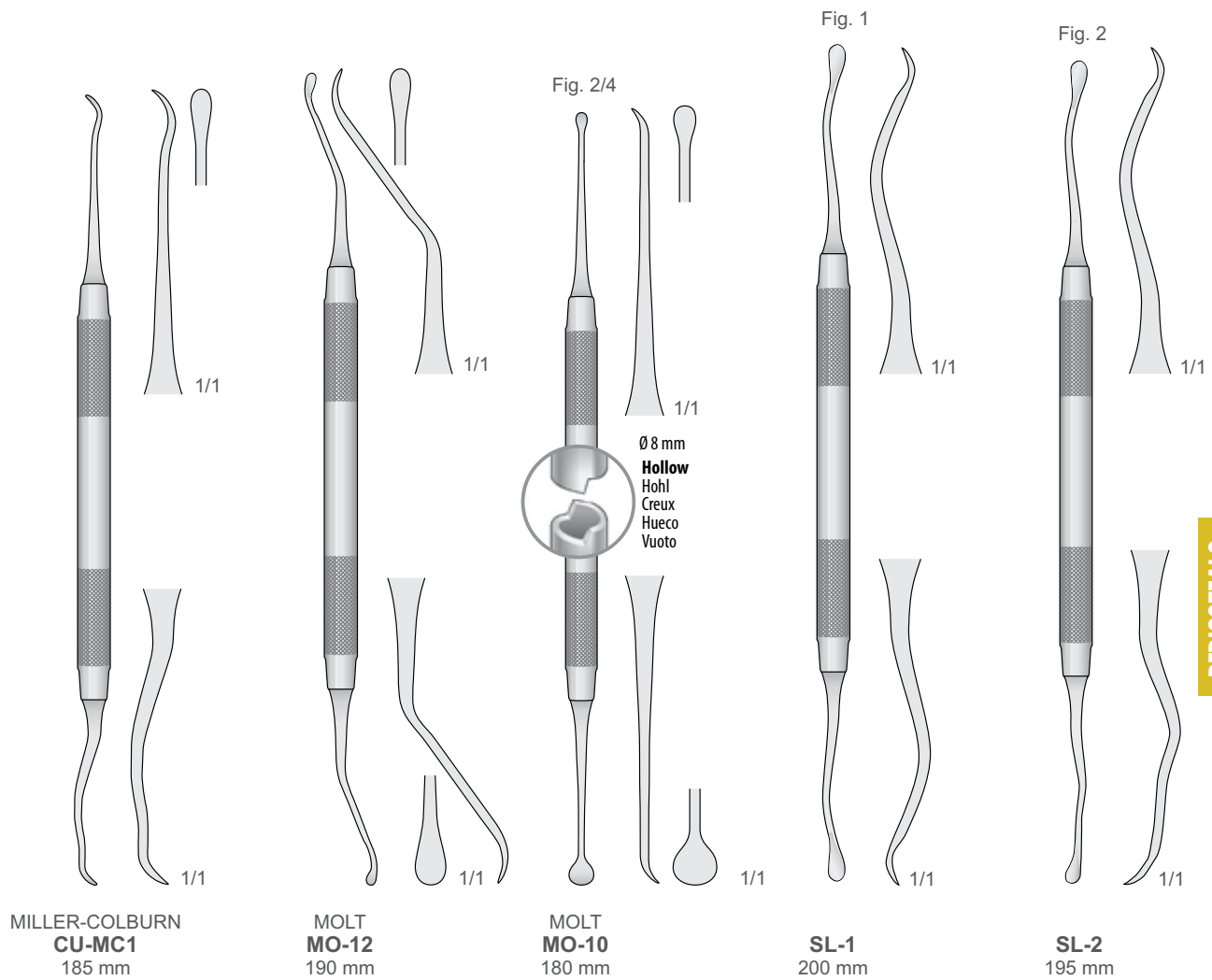
TASO-8

PERIOSTEALS  
 CURETTES &  
 BONE



Curettes  
 Küretten  
 Curettes  
 Curetas  
 Curettes

Instrumente für Sinuslift  
 Sinus Lift Instruments  
 Strumenti per rialzo del seno  
 Instrumentos para elevación de seno maxilar  
 Instruments d'élévation sinusienne

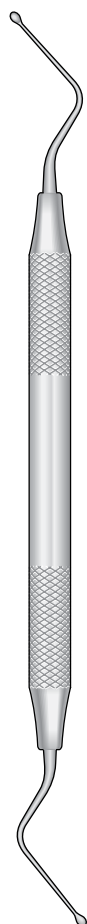


PERIOSTEALS  
 CURETTES &  
 BONE

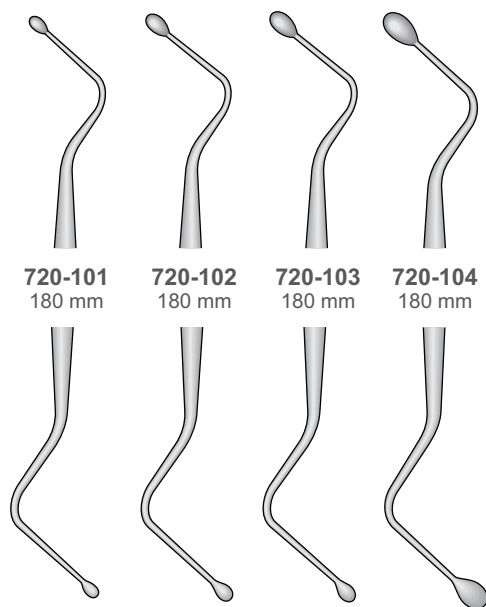


Runder Hohlgriff 8 mm  
Hollow Round Handle 8 mm  
Manico tondo vuoto 8 mm  
Mango hueco 8 mm  
Manche rond vide 8 mm

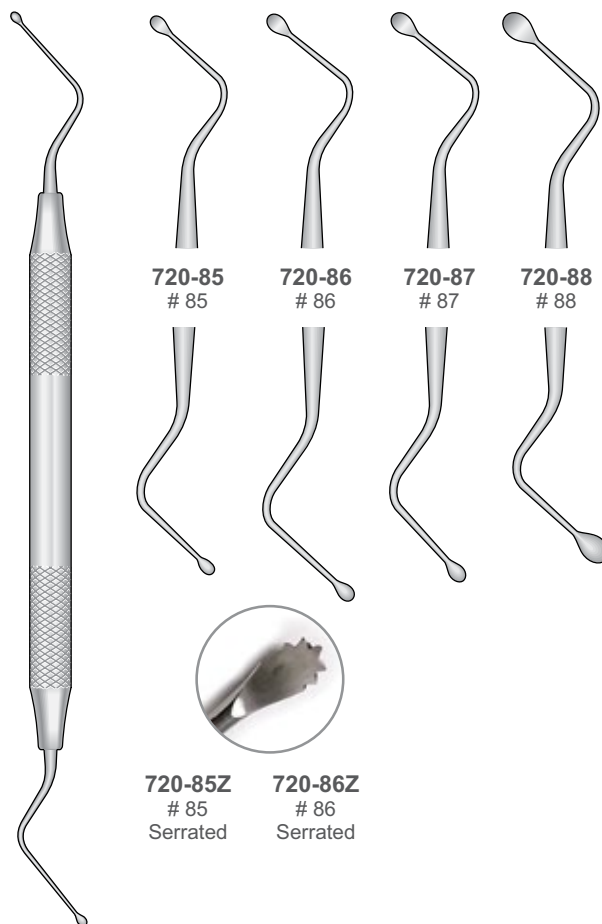
**PERIOSTEALS  
CURETTES &  
BONE**



HEMINGWAY  
720-101/720-104  
180 mm



720-101 180 mm  
720-102 180 mm  
720-103 180 mm  
720-104 180 mm



720-85 # 85  
720-86 # 86  
720-87 # 87  
720-88 # 88



720-85Z # 85 Serrated  
720-86Z # 86 Serrated

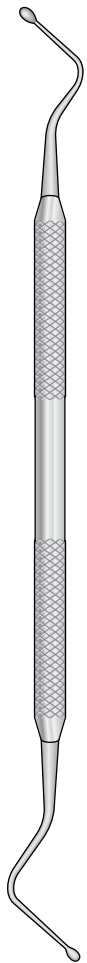
LUCAS  
720-85/720-88  
180 mm



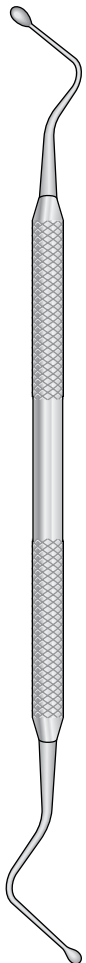


Küretten  
Curettes  
Curettes  
Curetas  
Curettes

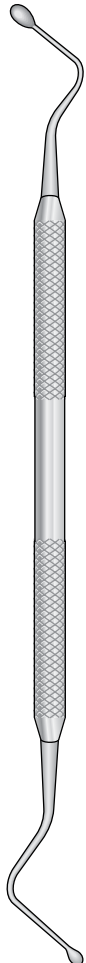
Wundhachen Mandibular  
Mandibular Nerve Diplace  
Per spostamento  
nervo mandibolare  
Para nero mandibular



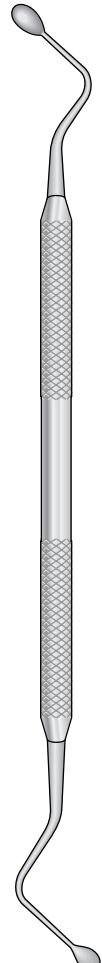
HEMINGWAY  
C-1  
170 mm



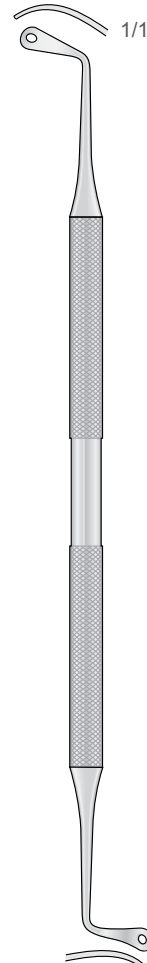
HEMINGWAY  
C-2  
170 mm



HEMINGWAY  
C-3  
170 mm



HEMINGWAY  
C-4  
170 mm

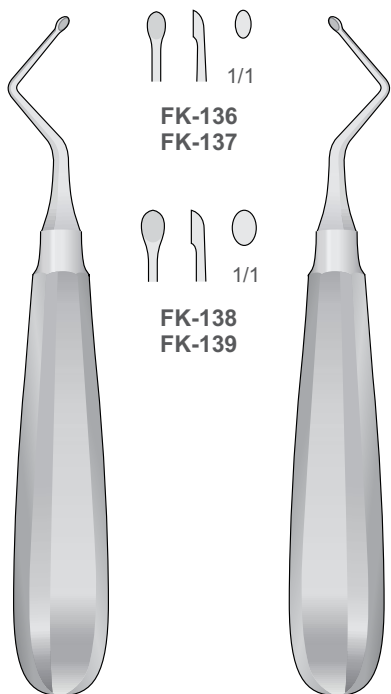


SL-21  
165 mm

PERIOSTEALS  
CURETTES &  
BONE



Küretten  
Curettes  
Curettes  
Curetas  
Curettes

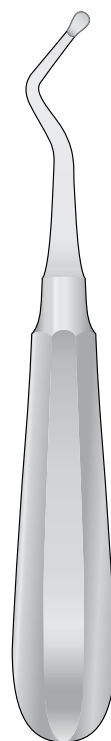


KERPEL  
FK-136  
FK-138  
145 mm

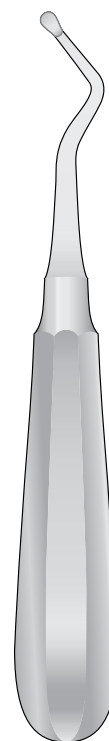
KERPEL  
FK-137  
FK-139  
145 mm



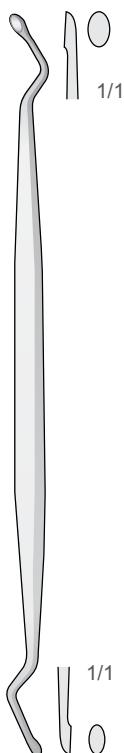
DL-50  
155 mm



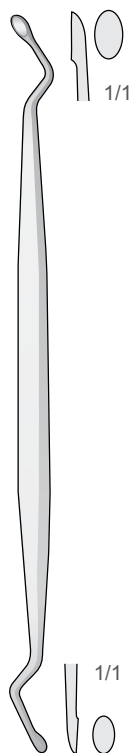
DL-51  
150 mm



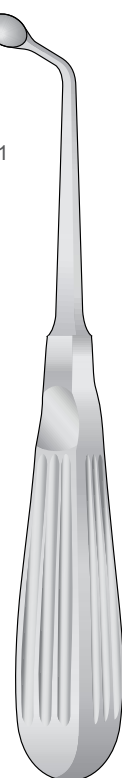
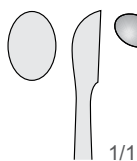
DL-52  
150 mm



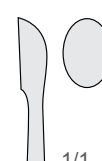
FK-83  
160 mm



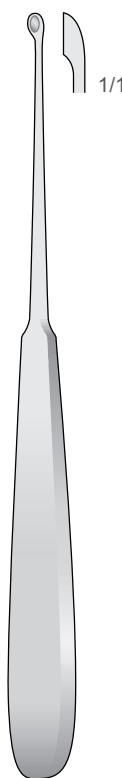
JANSEN  
FK-84  
160 mm



UFFENDORDE  
FK-188  
170 mm



UFFENDORDE  
FK-189  
170 mm



WILLIGER  
FK-197/FK-198  
170 mm

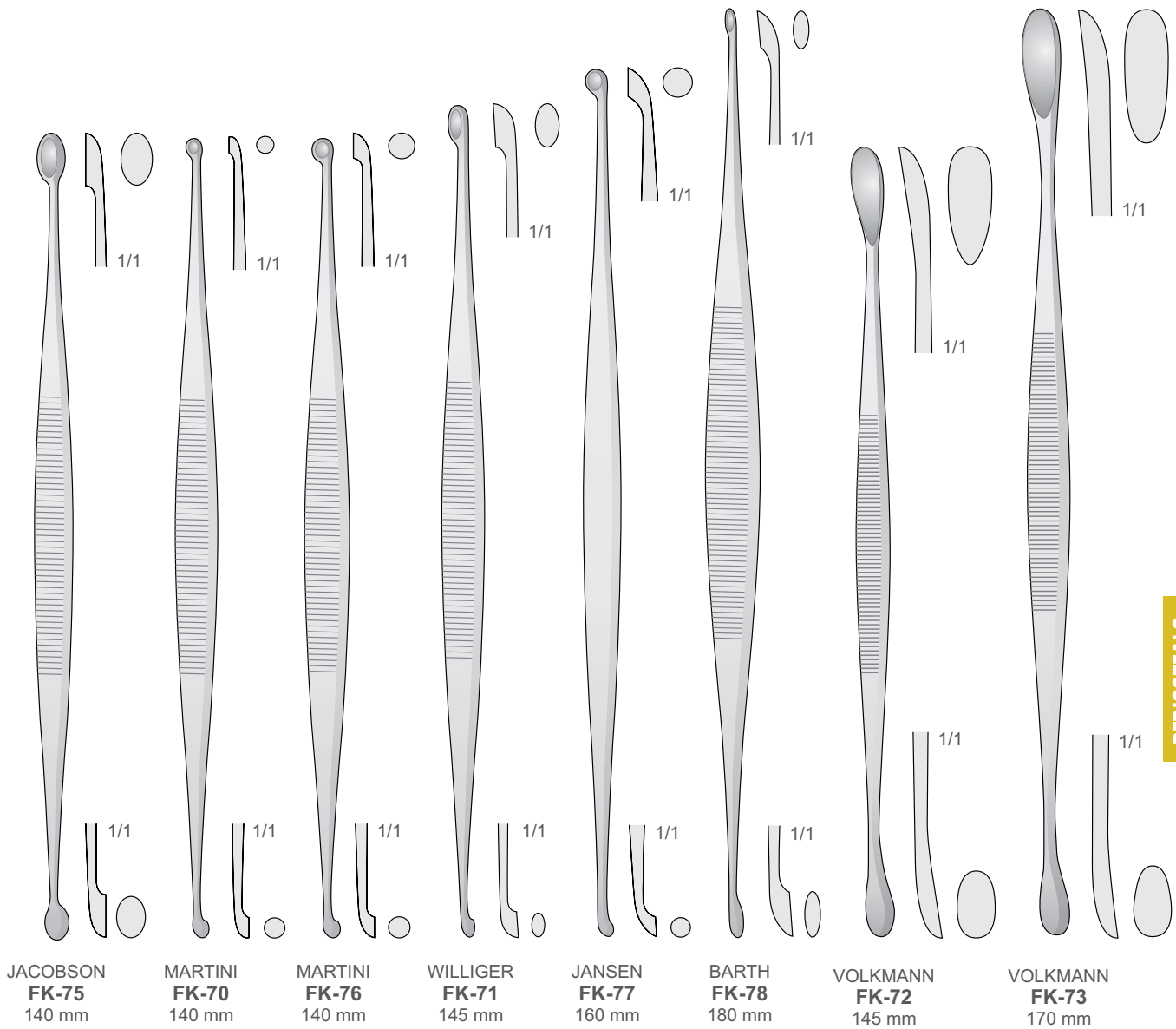
Fig. 00  
3,4 mm  
1/1  
FK-197

Fig. 1  
5,2 mm  
1/1  
FK-198

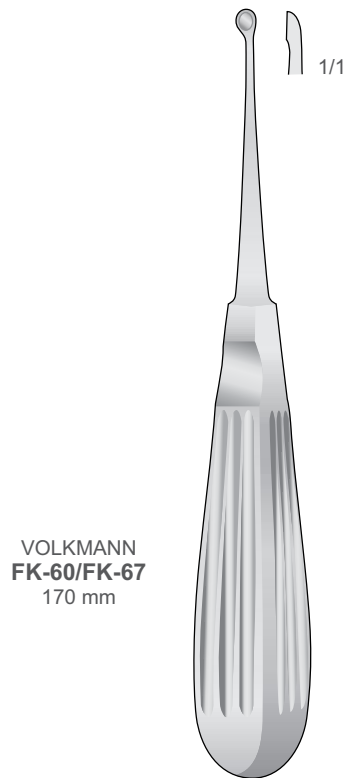
PERIOSTEALS  
CURETTES &  
BONE



Küretten  
Curettes  
Curettes  
Curetas  
Curettes



Küretten  
Curettes  
Curettes  
Curetas  
Curettes



VOLKMANN  
FK-60/FK-67  
170 mm

Fig.0000  
2,8 mm  
1/1  
FK-60

Fig.000  
3,6 mm  
1/1  
FK-61

Fig.00  
4,4 mm  
1/1  
FK-62

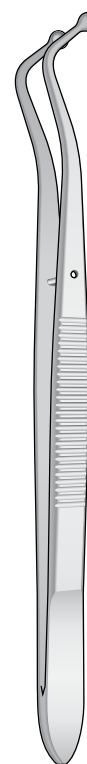
,Fig.0  
5,2 mm  
1/1  
FK-63

Fig.1  
6,8 mm  
1/1  
FK-64

Fig.2  
8,5 mm  
1/1  
FK-65

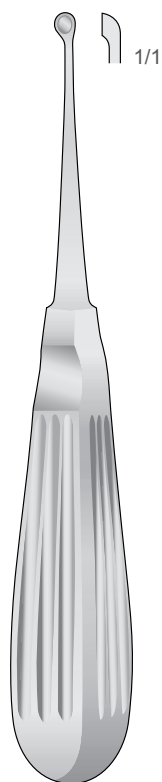
Fig.3  
10 mm  
1/1  
FK-66

Fig.4  
11,5 mm  
1/1  
FK-67



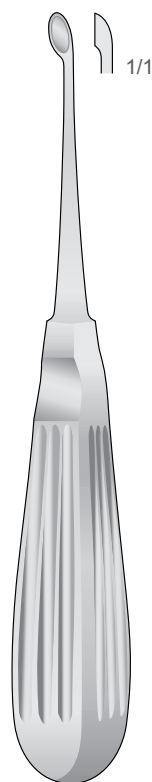
COLLEGE  
CURETTE  
MIR-10  
160 mm

PERIOSTEALS  
CURETTES &  
BONE



BRUNS  
FK-110/FK-116  
165 mm

3 mm FK-110	4 mm FK-111	5 mm FK-112
6 mm FK-113	8 mm FK-114	
10 mm FK-115	12 mm FK-116	

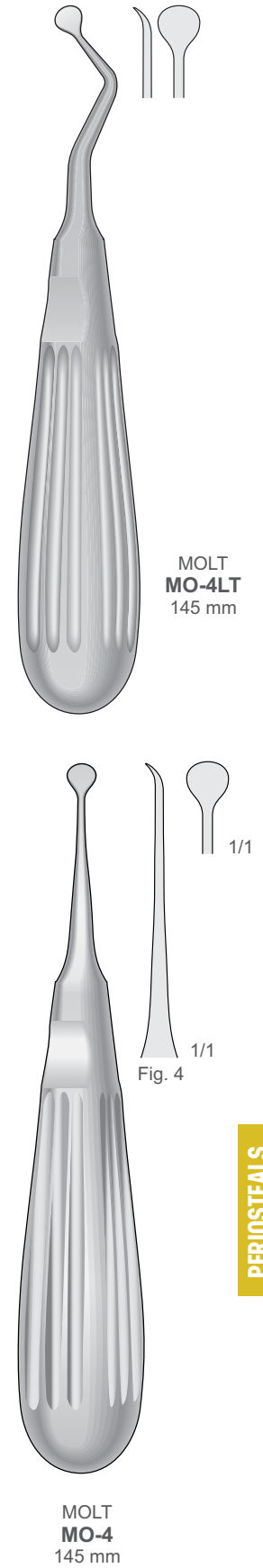
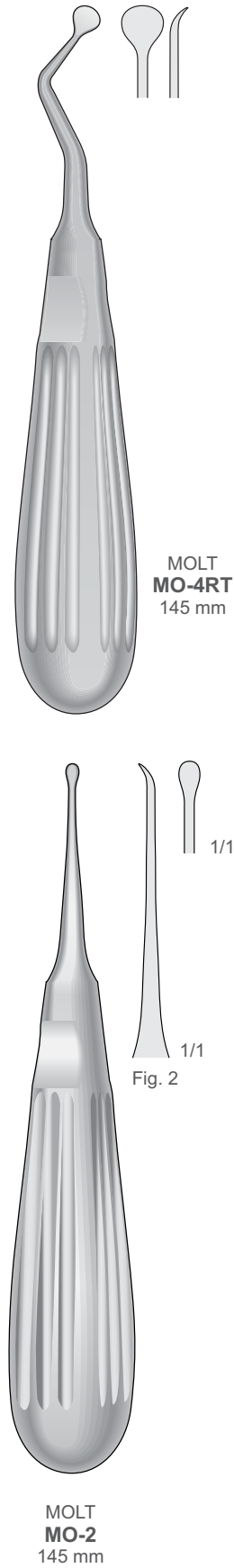
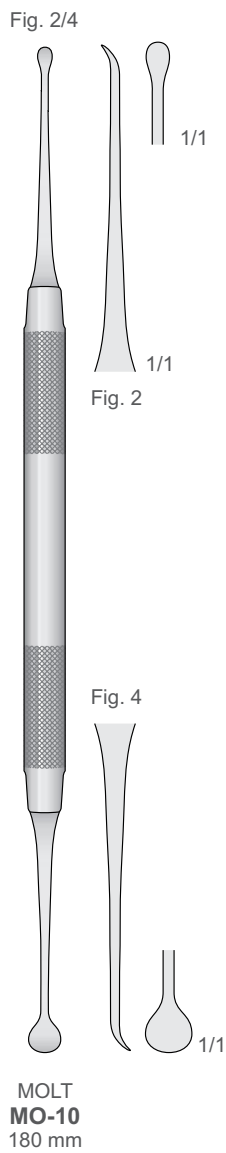
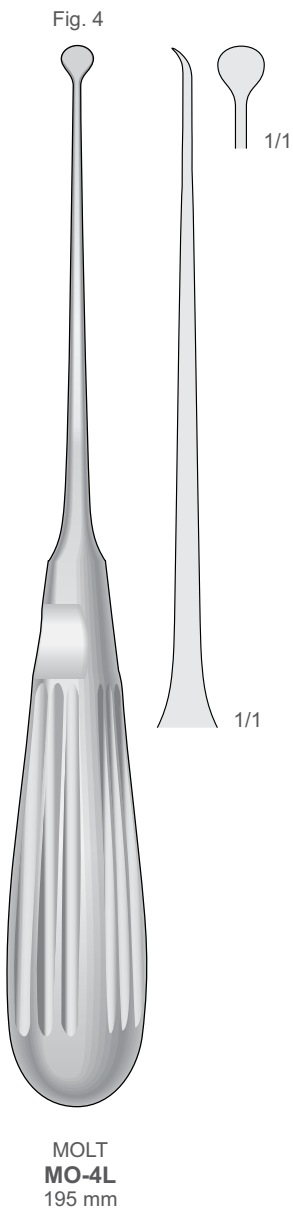


SCHEDE  
FK-120/FK-126  
170 mm

2,5 mm FK-120	3,4 mm FK-121	4,2 mm FK-122
5,2 mm FK-123	6,3 mm FK-124	
7,4 mm FK-125	8 mm FK-126	



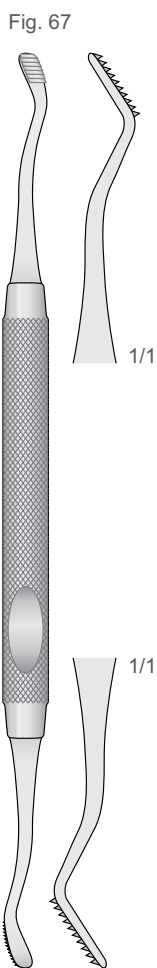
Chirurgische Küretten  
 Surgical Curettes  
 Curette chirurgiche  
 Curetas quirúrgicas  
 Curettes chirurgicales



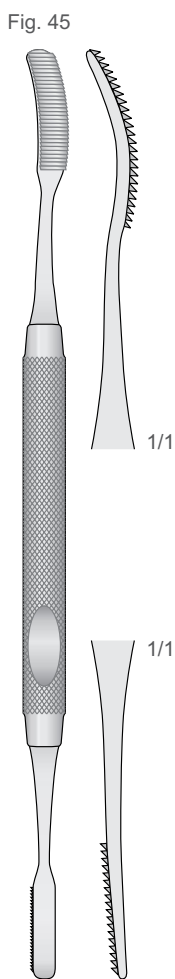
PERIOSTEALS  
 CURETTES &  
 BONE



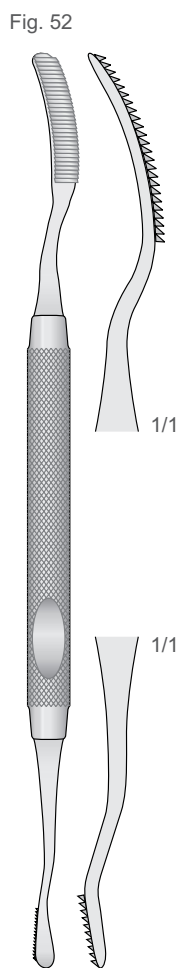
PERIOSTEALS  
 CURETTES &  
 BONE



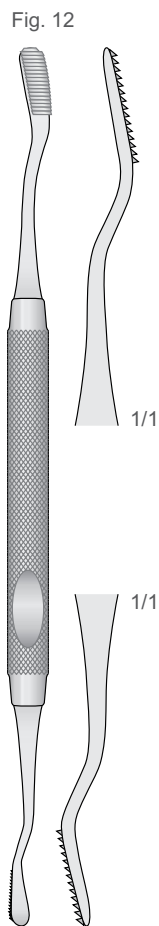
HOWARD  
**DO-1**  
 180 mm



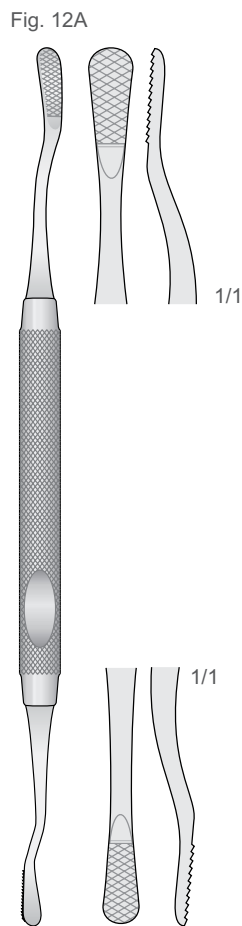
MILLER  
**DO-2**  
 185 mm



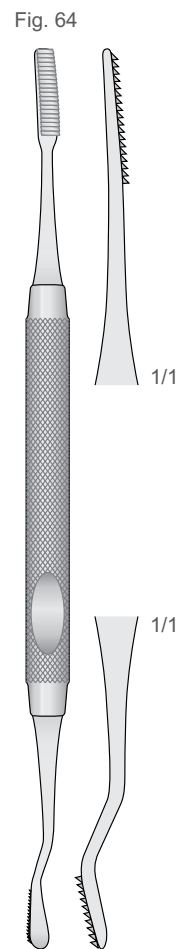
MILLER  
**DO-3**  
 180 mm



HOWARD  
**DO-4**  
 170 mm



MILLER  
**DO-4C**  
 170 mm



MILLER  
**DO-5**  
 175 mm

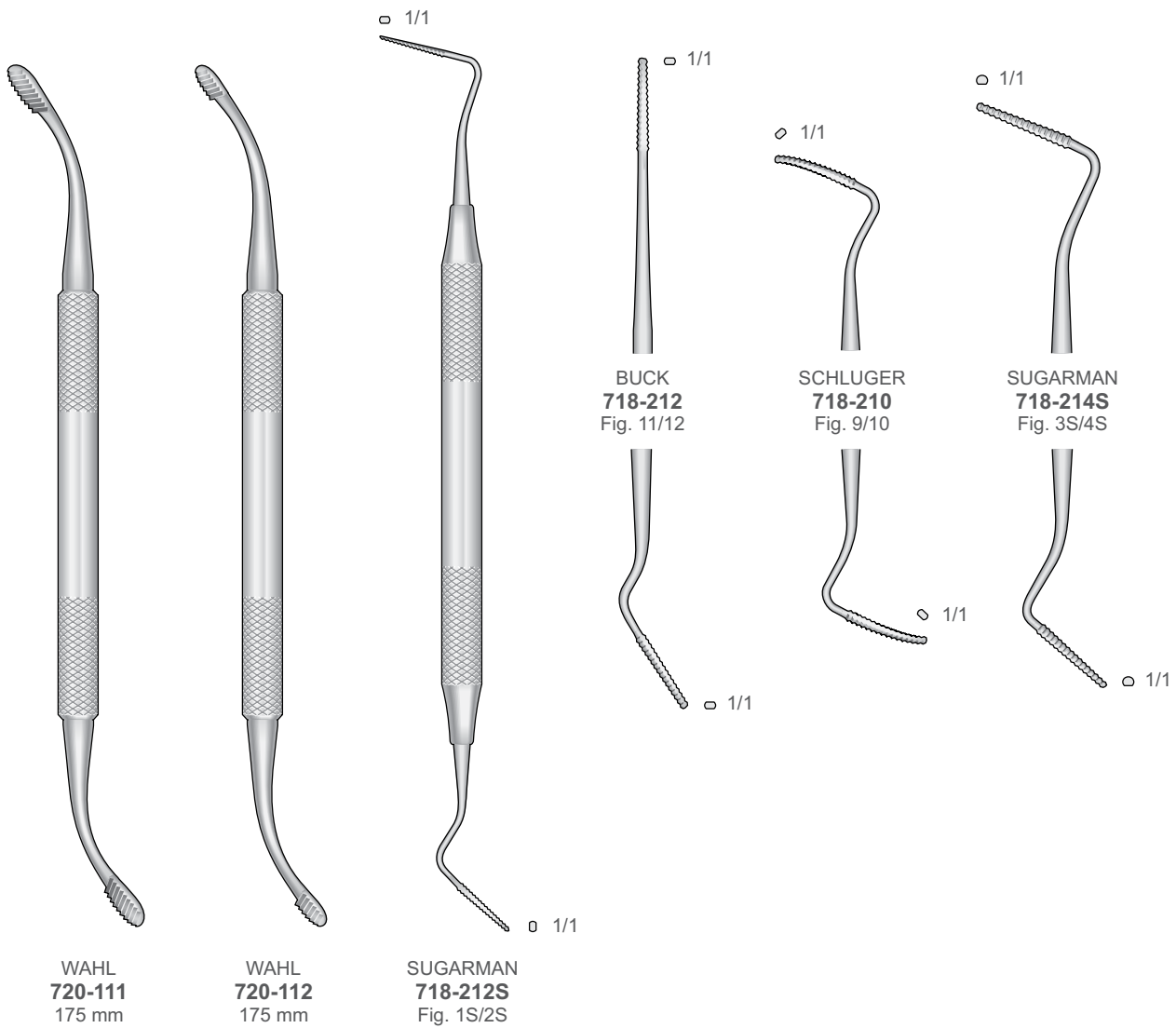


Knochenfeilen  
 Bone Files  
 Lime per osso  
 Limas para hueso  
 Limes à os

Runder Hohlgriff 8 mm  
 Hollow Round Handle 8 mm  
 Manico tondo vuoto 8 mm  
 Mango hueco 8 mm  
 Manche rond vide 8 mm



Parodontal Feilen  
 Periodontal Files  
 Lime parodontali  
 Limas periodontales  
 Limes parodontales

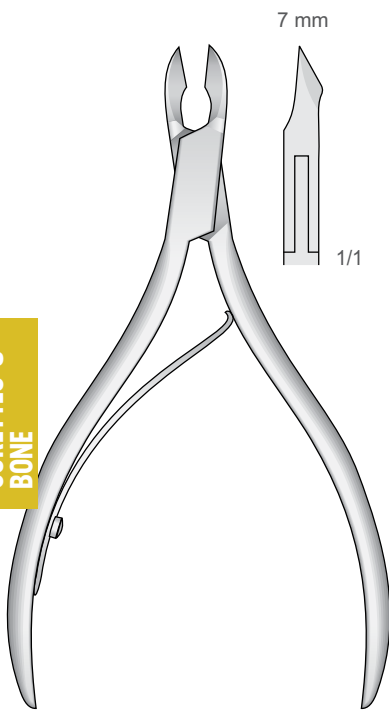


PERIOSTEALS  
 CURETTES &  
 BONE

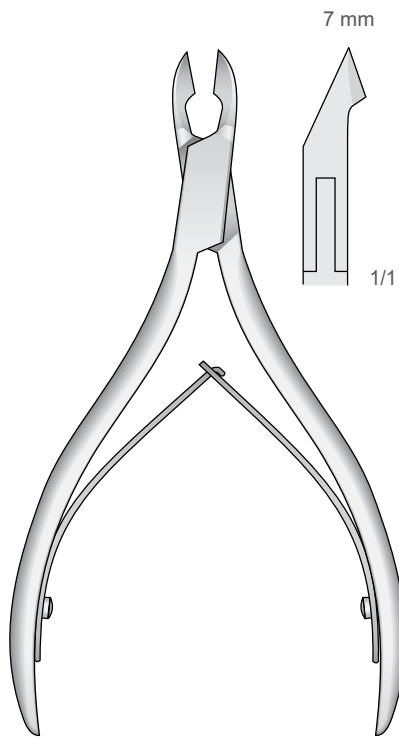


Gewebezängchen  
Tissue Nippers  
Tronchesi per gengive e tessuti  
Pinzas para cortar tejidos  
Pincas coupante pour tissue

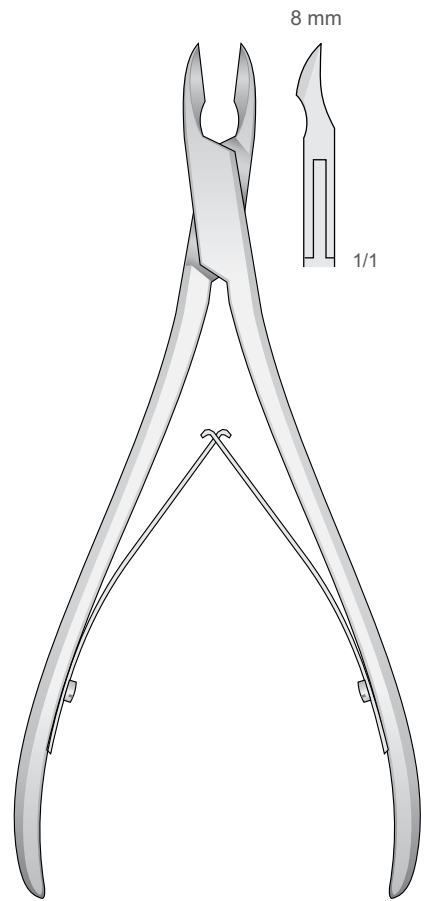
PERIOSTEALS  
CURETTES &  
BONE



CHOEN  
LX-60  
105 mm



ILIC  
LX-50  
115 mm

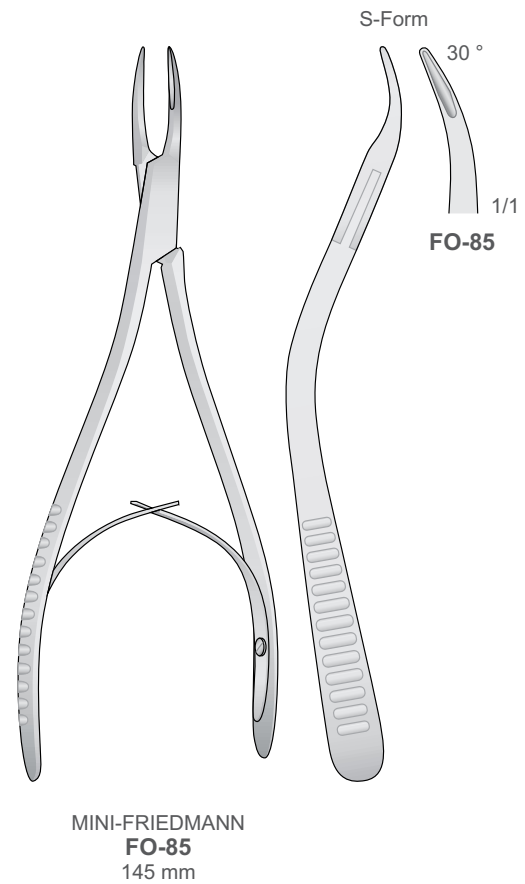
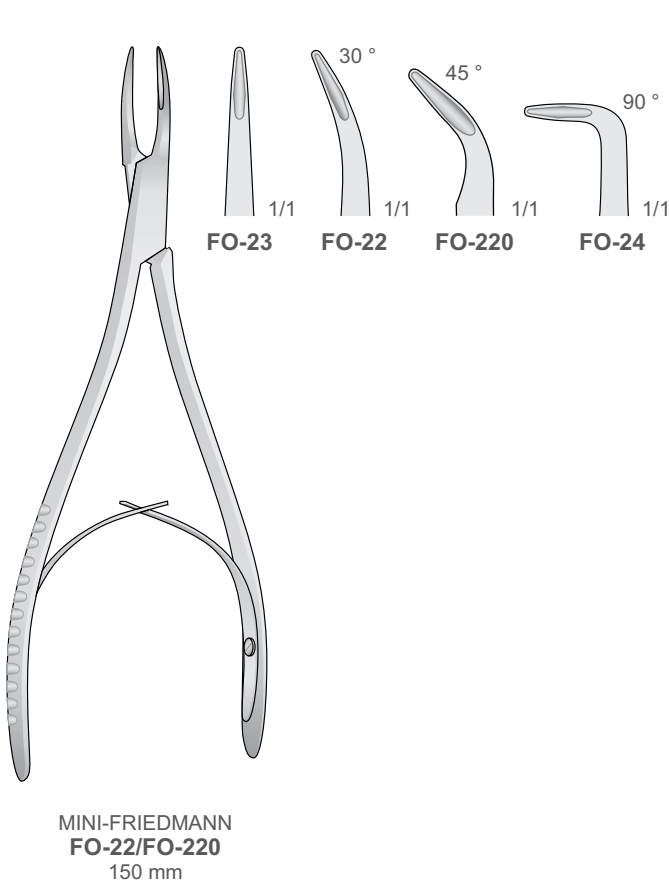
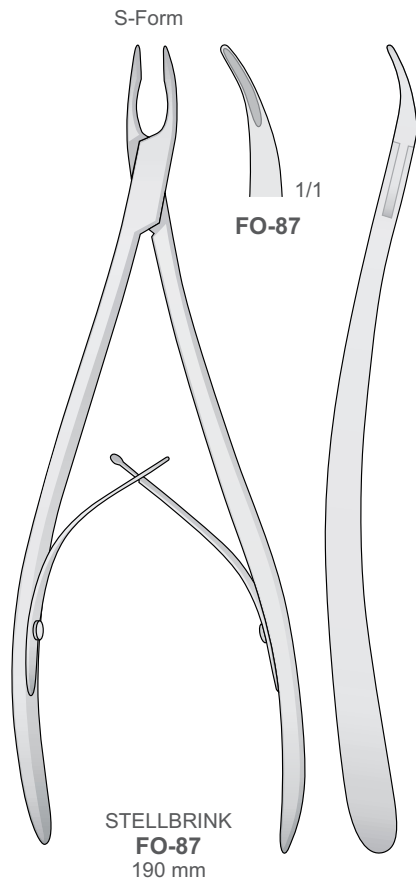


LX-52  
140 mm



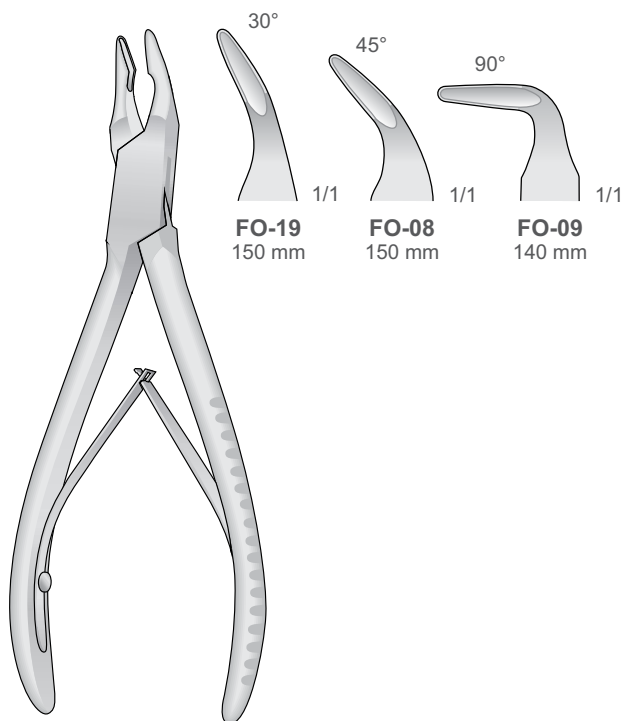


Hohlmeißelzangen  
 Bone rongeurs  
 Pinze ossivore  
 Pinzas gubias  
 Pincas gougues

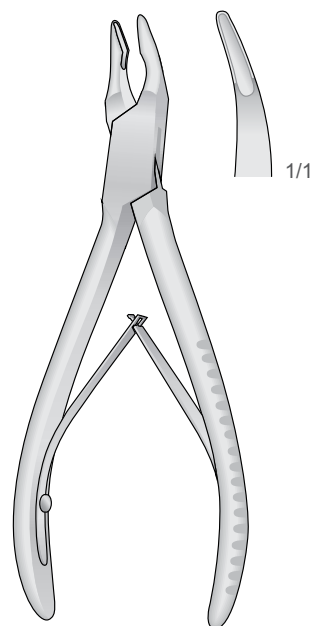


PERIOSTEALS  
 CURETTES &  
 BONE

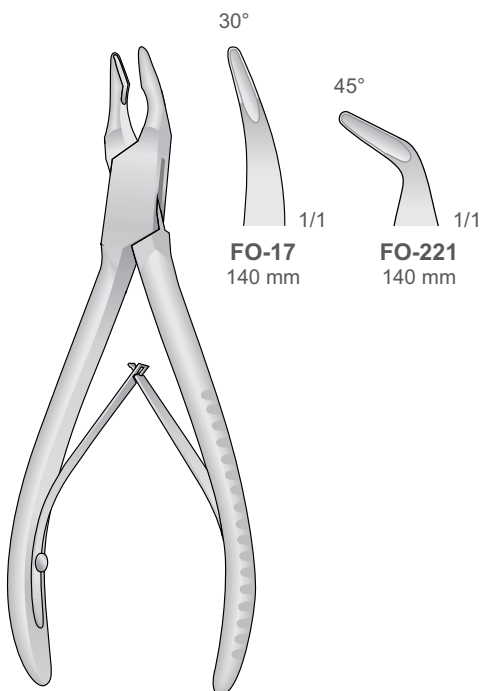
Hohlmeißelzangen  
 Bone rongeurs  
 Pinze ossivore  
 Pinzas gubias  
 Pincas gouges



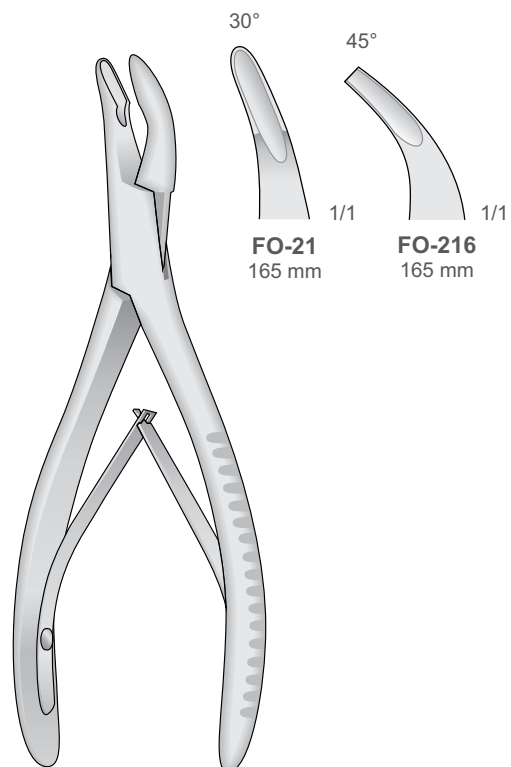
**BLUMENTHAL**  
**FO-08/FO-19**



**MINI FRIEDMAN**  
**FO-15**  
 120 mm



**FRIEDMANN**  
**FO-17/FO-221**  
 140 mm

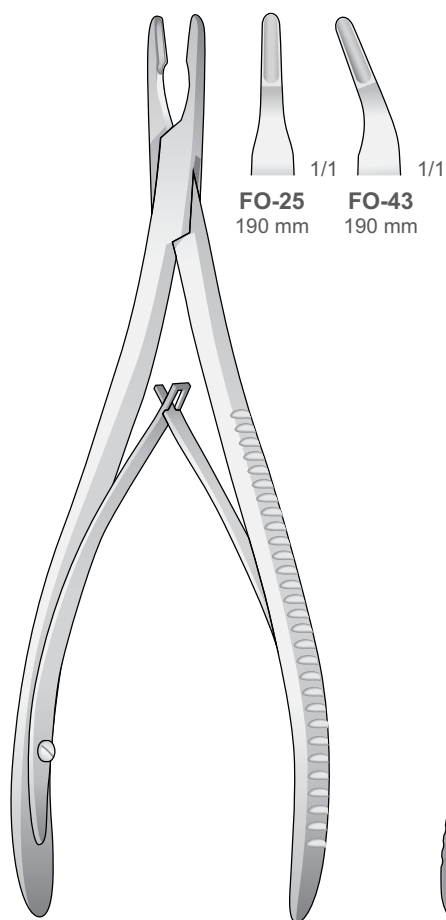


**MEAD**  
**FO-21/FO-216**  
 165 mm

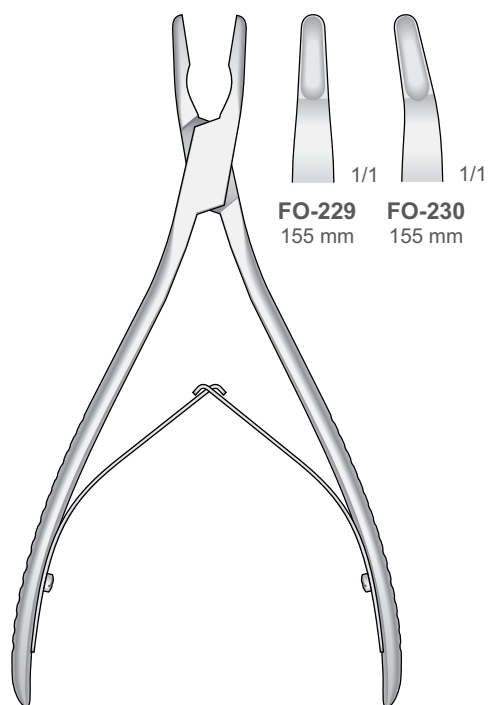
PERIOSTEALS  
 CURETTES &  
 BONE



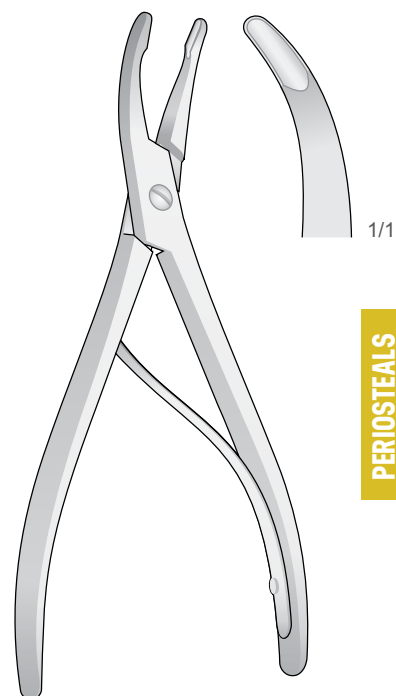
Hohlmeißelzangen  
Bone rongeurs  
Pinze ossivore  
Pinzas gubias  
Pinces gouges



LEMPERT  
FO-25/FO-43  
190 mm



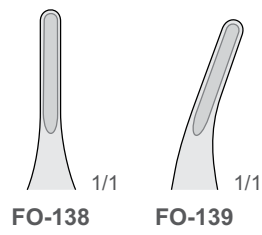
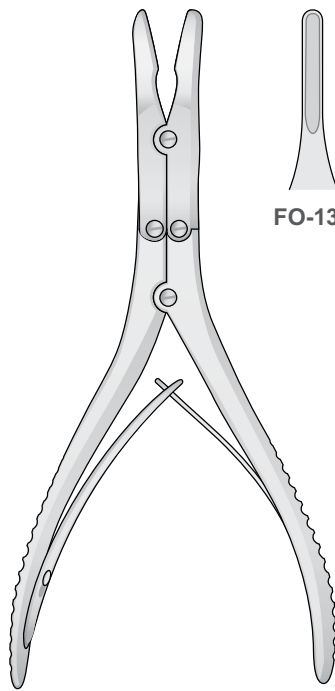
LEMPERT  
FO-229/FO-230  
155 mm



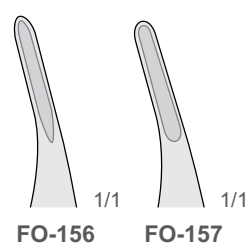
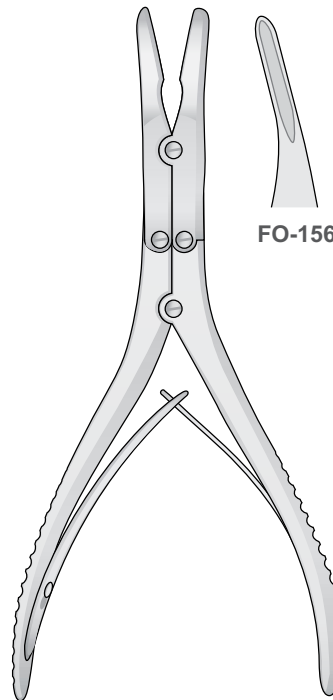
LUER  
FO-18  
155 mm

PERIOSTEALS  
CURETTES &  
BONE

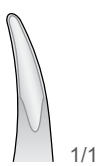
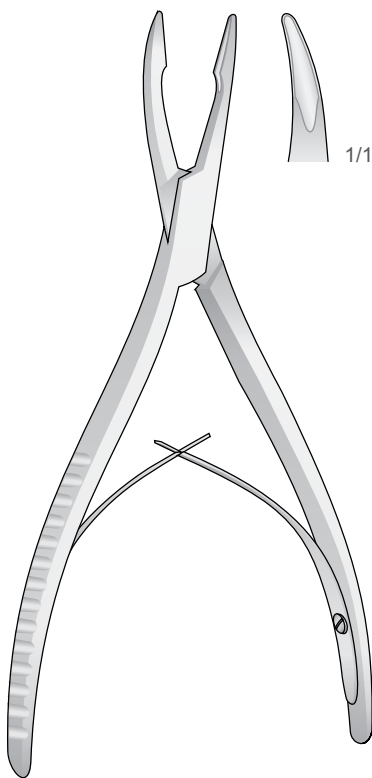
Hohlmeißelzangen  
 Bone rongeurs  
 Pinze ossivore  
 Pinzas gubias  
 Pincas gouges



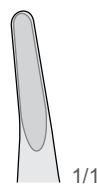
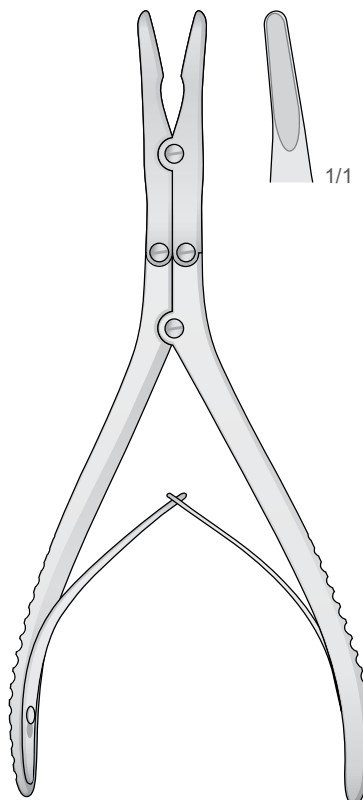
**RUSKIN**  
**FO-138/FO-139**  
 150 mm



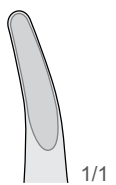
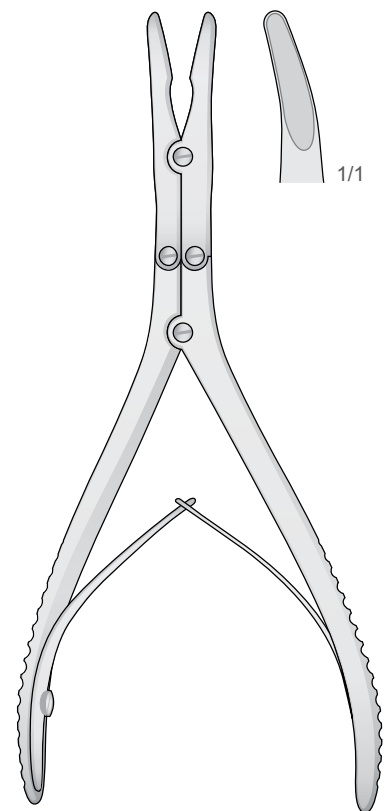
**KLEINERT-KUTZ**  
**FO-156/FO-157**  
 155 mm



**FRIEDMANN**  
**FO-16**  
 160 mm



**BEYER**  
**FO-20**  
 180 mm

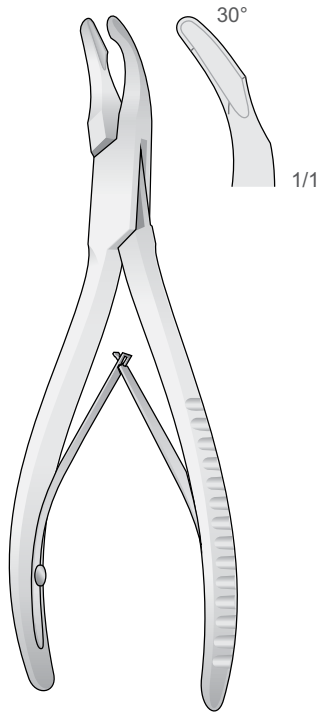


**ZAUFAL-JANSEN**  
**FO-34**  
 180 mm

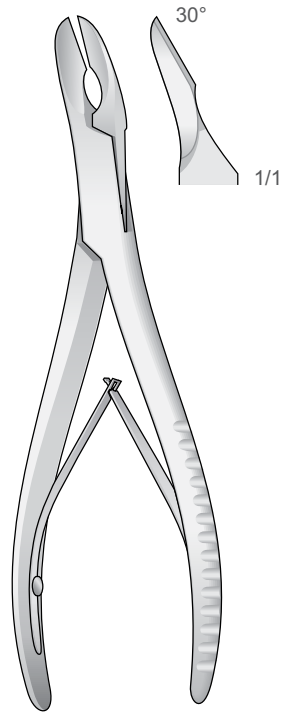
PERIOSTEALS  
 CURETTES &  
 BONE



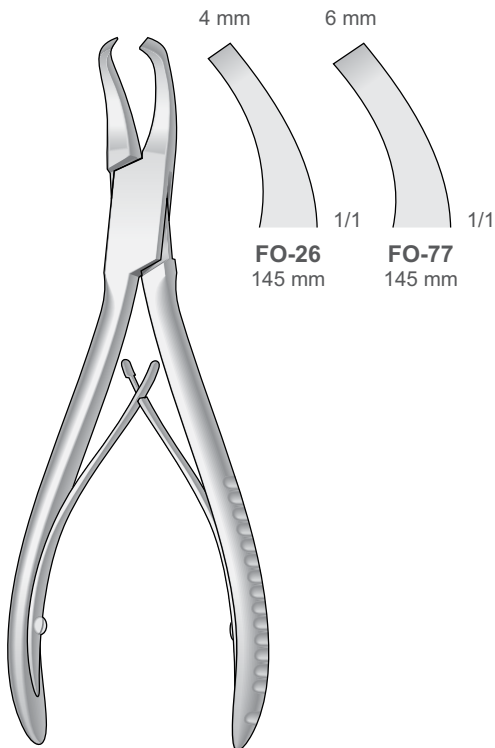
Hohlmeißelzangen  
 Bone rongeurs  
 Pinze ossivore  
 Pinzas gubias  
 Pincas gouges



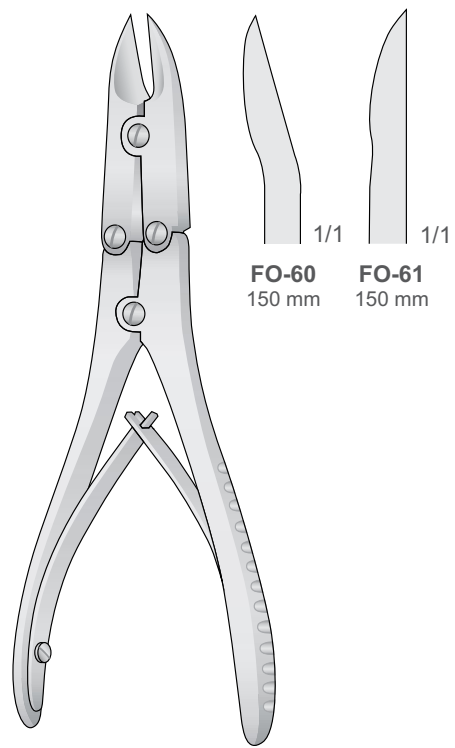
CLEVELAND  
**FO-231** 140 mm  
**FO-232** 170 mm



CLEVELAND  
**FO-233** 150 mm  
**FO-234** 170 mm



GARDNER  
**FO-26/FO-77**  
 145 mm

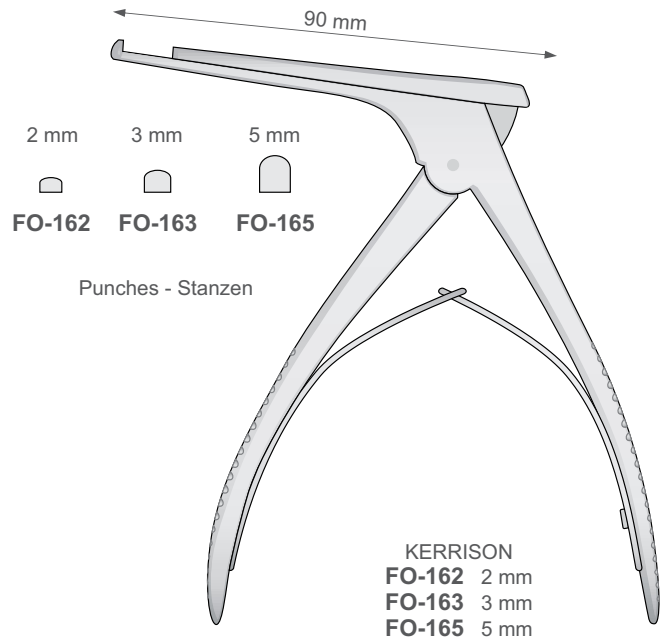


BÖHLER  
**FO-60/FO-61**  
 150 mm

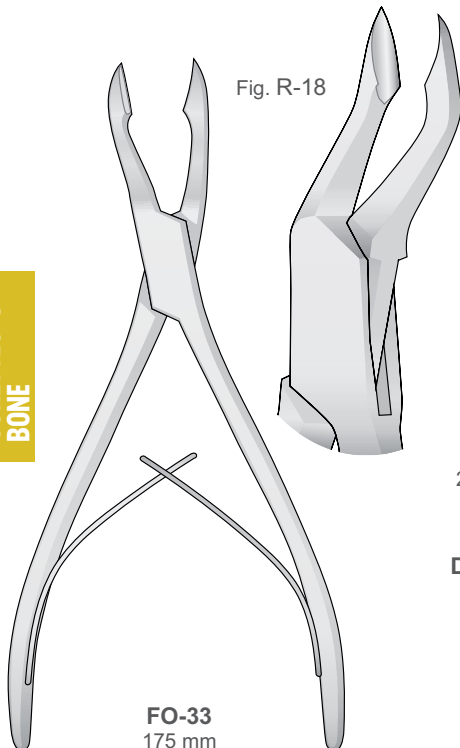
PERIOSTEALS  
 CURETTES &  
 BONE



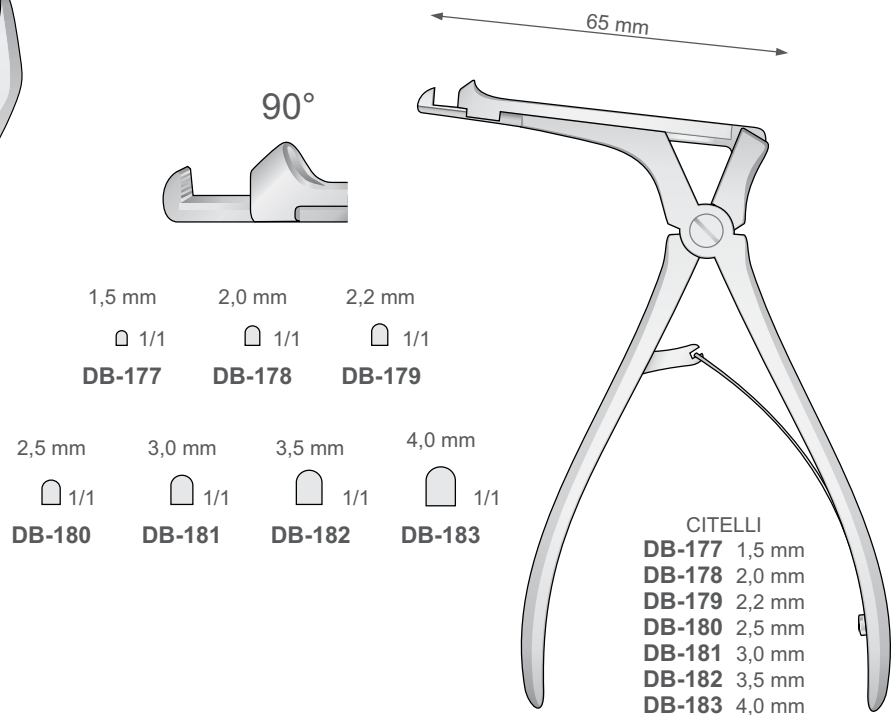
Knochensplitterzangen  
 Bone cutting forceps  
 Pinze ossivore  
 Pinzas cortantes para huesos  
 Pinces coupantes à os



PERIOSTEALS  
 CURETTES &  
 BONE



Bone cutting forceps  
 for opening the Sinus  
 Strumento tagliente per  
 aumentare il volume del seno





we take a closer look

# PERIODONTICS ENDODONTICS RESTORATION



Periodontics  
Endodontics  
Diagnostic  
Curettes and Scalers  
Amalgam  
Composite

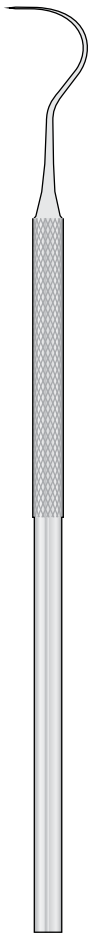


Spatulas  
Filling  
Dental Restoration  
Perio Chisels and  
Knives  
Perio Probes and  
Explorers  
Filling  
Curettes and Scalers  
Rubber-Dam

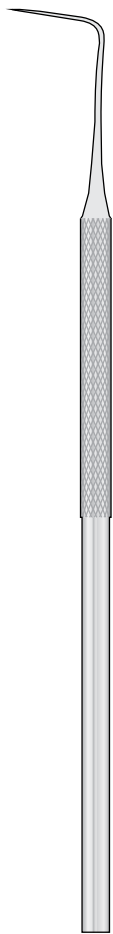




Zahnsonden  
Explorers - Sickle Probes  
Esploratori - Sonde falce  
Sondas exploradoras  
Sondes exploratrices



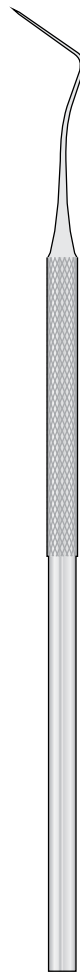
**SO-1**  
Fig. 23



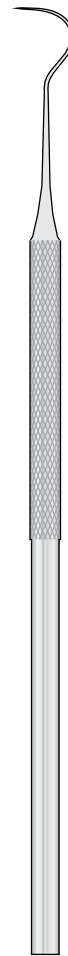
**SO-2**  
Fig. 11



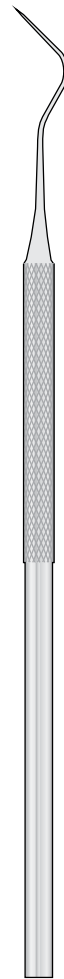
**SO-3**  
Fig. 6



**SO-4**  
Fig. 9



**SO-5**  
Fig. 2



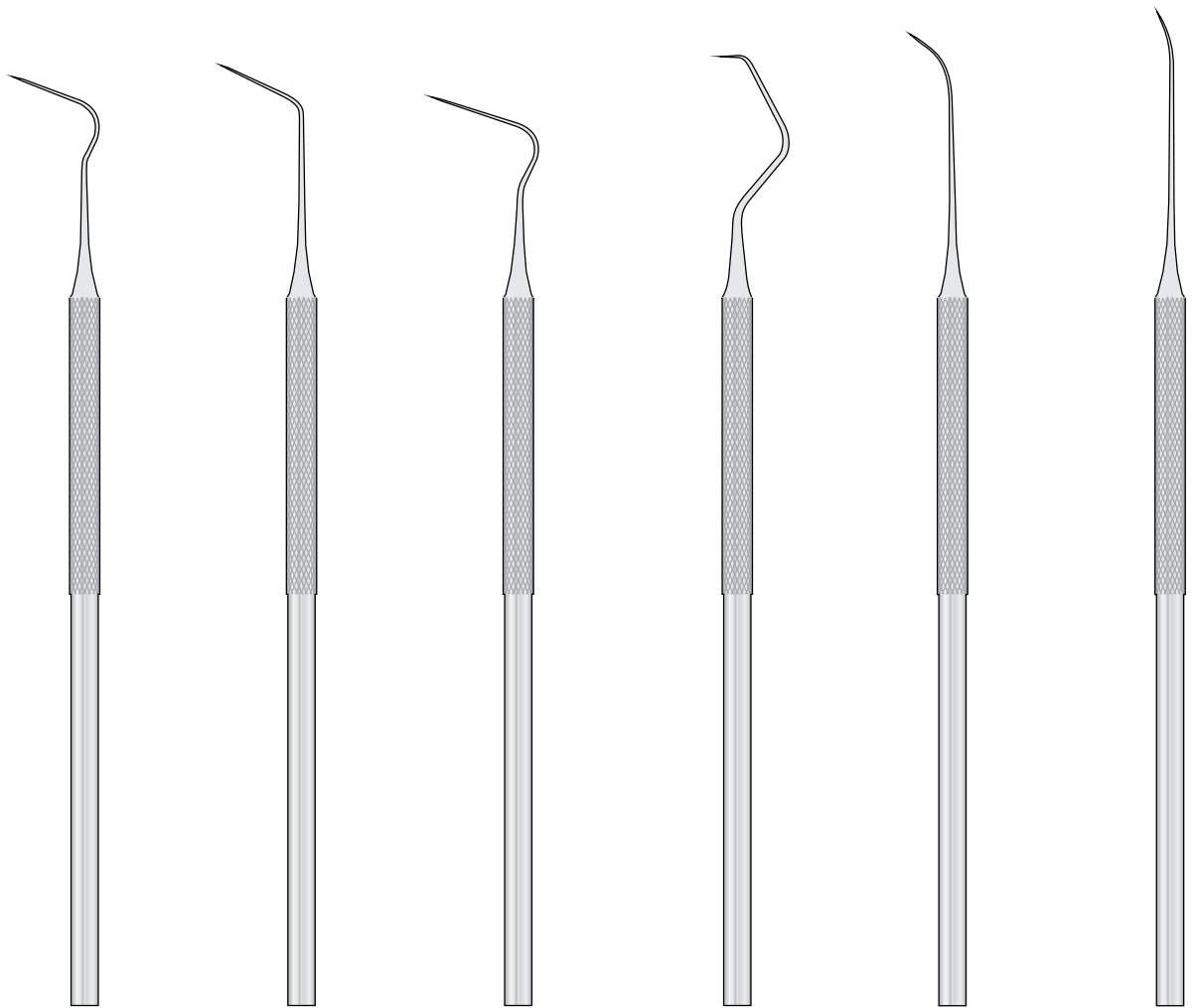
**SO-6**  
Fig. 10

PERIOSTEALS  
CURETTES &  
BONE



Zahnsonden  
Explorers - Sickle Probes  
Esploratori - Sonde falce  
Sondas exploradoras  
Sondes exploratrices

PERIOSTEALS  
CURETTES &  
BONE



**SO-7**  
Fig. 12

**SO-8**  
Fig. 6A

**SO-9**  
Fig. 8A

**SO-10**  
Fig. 17A

**SO-11**  
Fig. 3A

**SO-12**  
Fig. 3

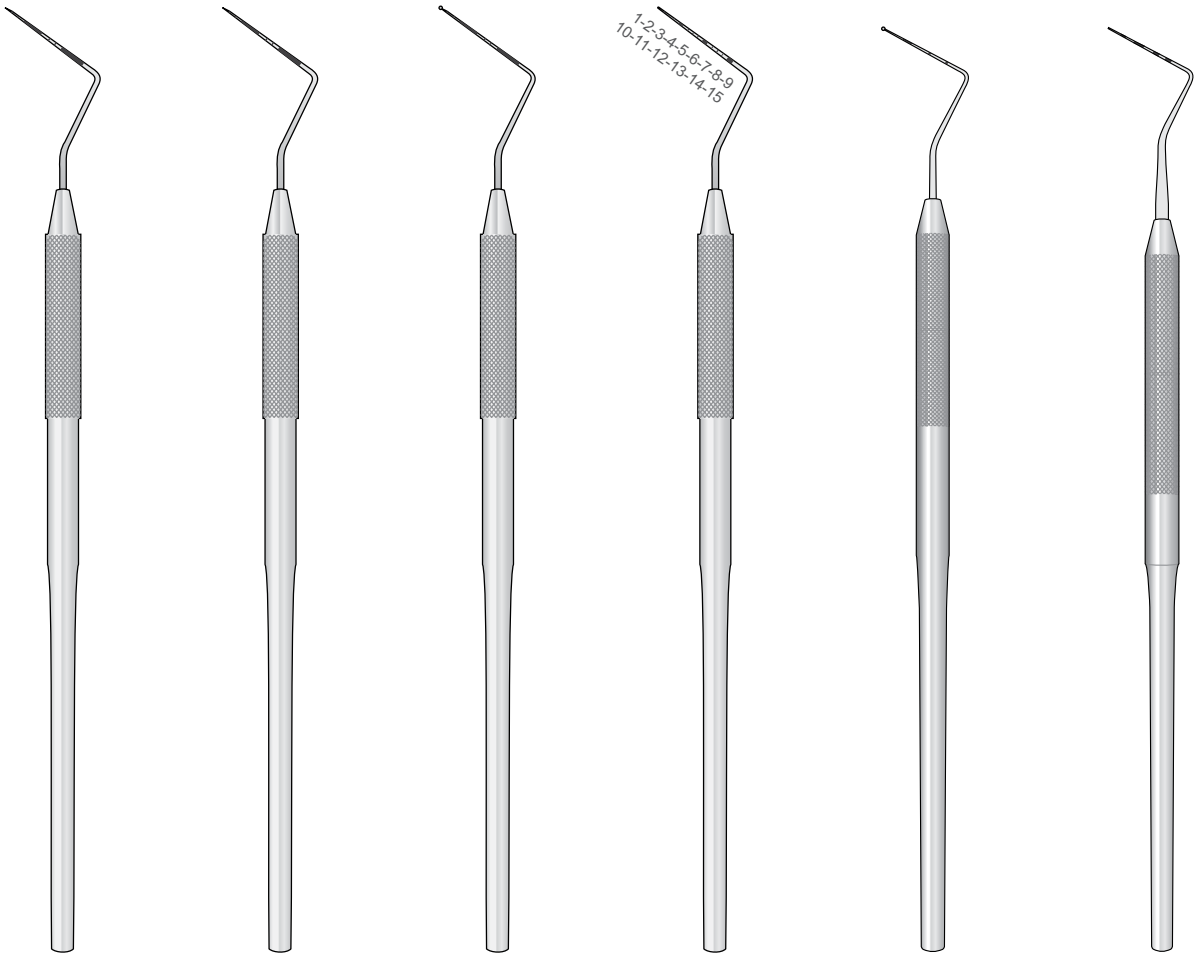
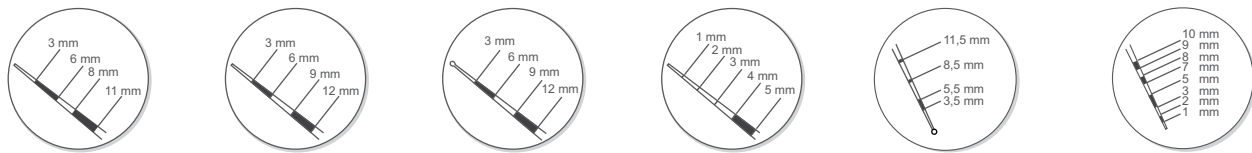


Parodontometer  
 Periodontal Probes  
 Sonde parodontali  
 Sondas parodontales  
 Sondes parodontales

**Do not use Ultrasonic Cleaning**  
 Verwenden Sie keine Ultraschall-Reinigung  
 Ne pas utiliser nettoyage à ultrasons  
 No usar limpieza ultrasónica  
 Non usare lavatrici ad ultrasuoni



**Do not use metal brushes**  
 Keine Drahtbürste verwenden  
 Ne pas utiliser de brosses métalliques  
 No utilizar cepillos metálicos  
 Non utilizzare spazzole metalliche



CP-11  
**SM-11**  
 160 mm

CP-12  
**SM-12**  
 160 mm

CP-12S  
**SM-13**  
 160 mm

CP-15UNC  
**SM-15**  
 160 mm

WHO  
**SM-21**  
 160 mm

CP-10  
**SM-19**  
 160 mm

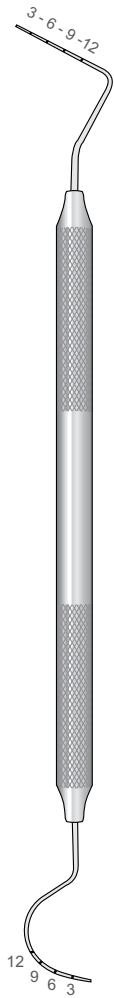
PERIOSTEALS  
 CURETTES &  
 BONE



Double-ended Explorer  
 Doppelendiger Zahnsonden  
 Sonde exploratrice double  
 Sonda exploradora doble  
 Sonda falce doppia



11/12 ODU  
**SO-20**  
 165 mm

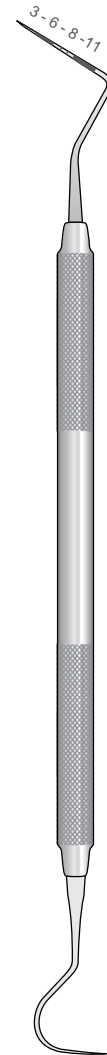
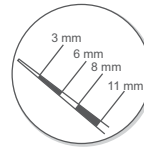


CATTONI  
 UT3/4  
**SM-20**  
 165 mm

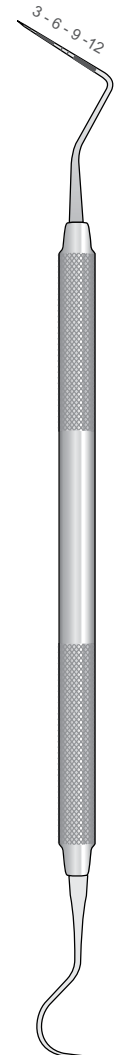
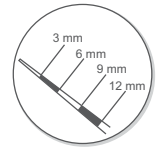
3 - 6 - 9 - 12



12 - 9 - 6 - 3  
 NABERS  
 2QN  
**SM-22**  
 175 mm



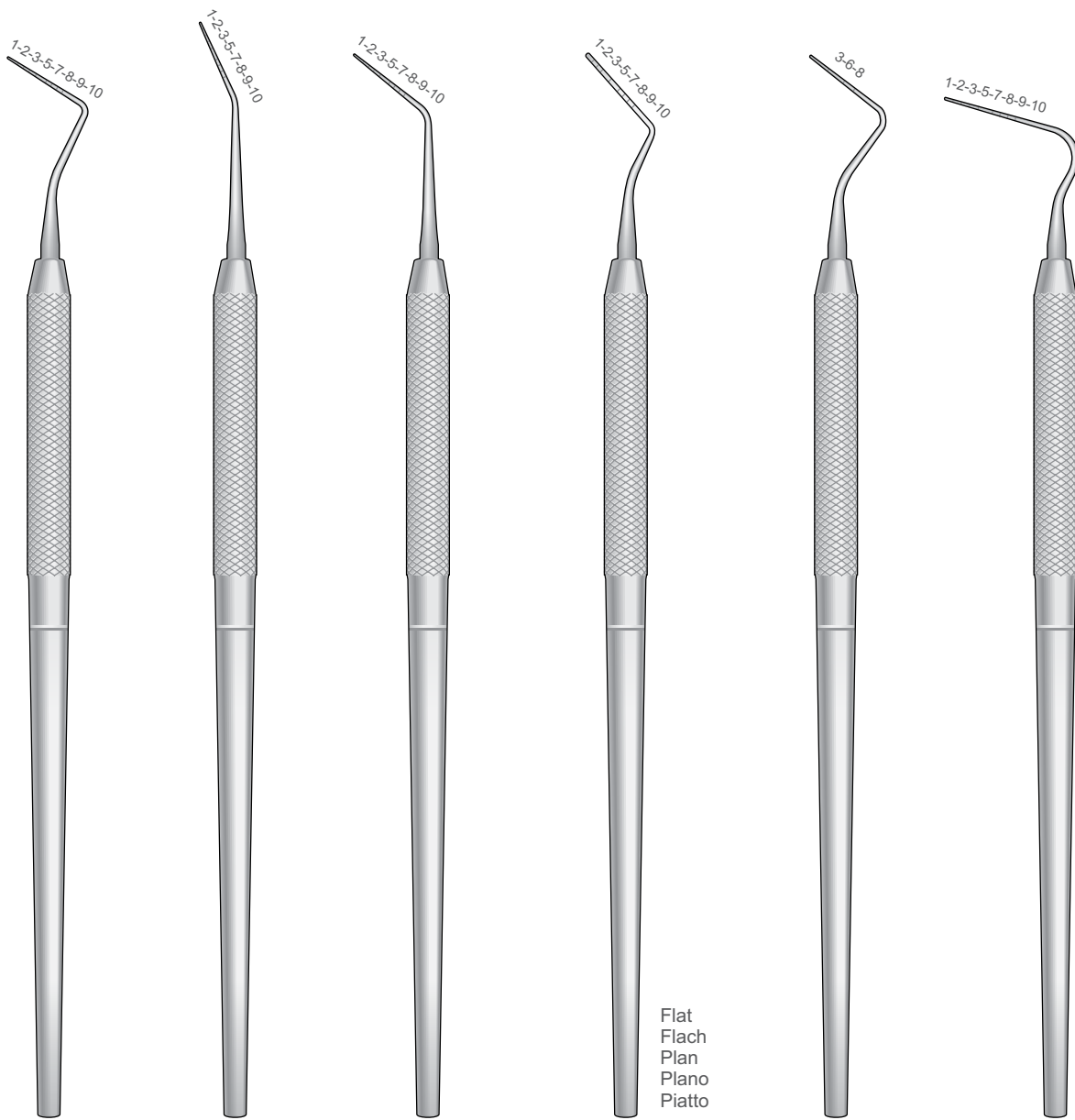
3 - 6 - 8 - 11  
 WILLIAMS  
 23 CP-11  
**EX-11**  
 165 mm



3 - 6 - 9 - 12  
 WILLIAMS  
 23 CP-12  
**EX-12**  
 165 mm



Parodontometer  
Periodontal Probes  
Sonde parodontali  
Sondas parodontales  
Sondes parodontales



WILLIAMS  
SM-1

MERRITT A  
SM-2

MERRITT B  
SM-3

GOLDMAN-FOX  
SM-4

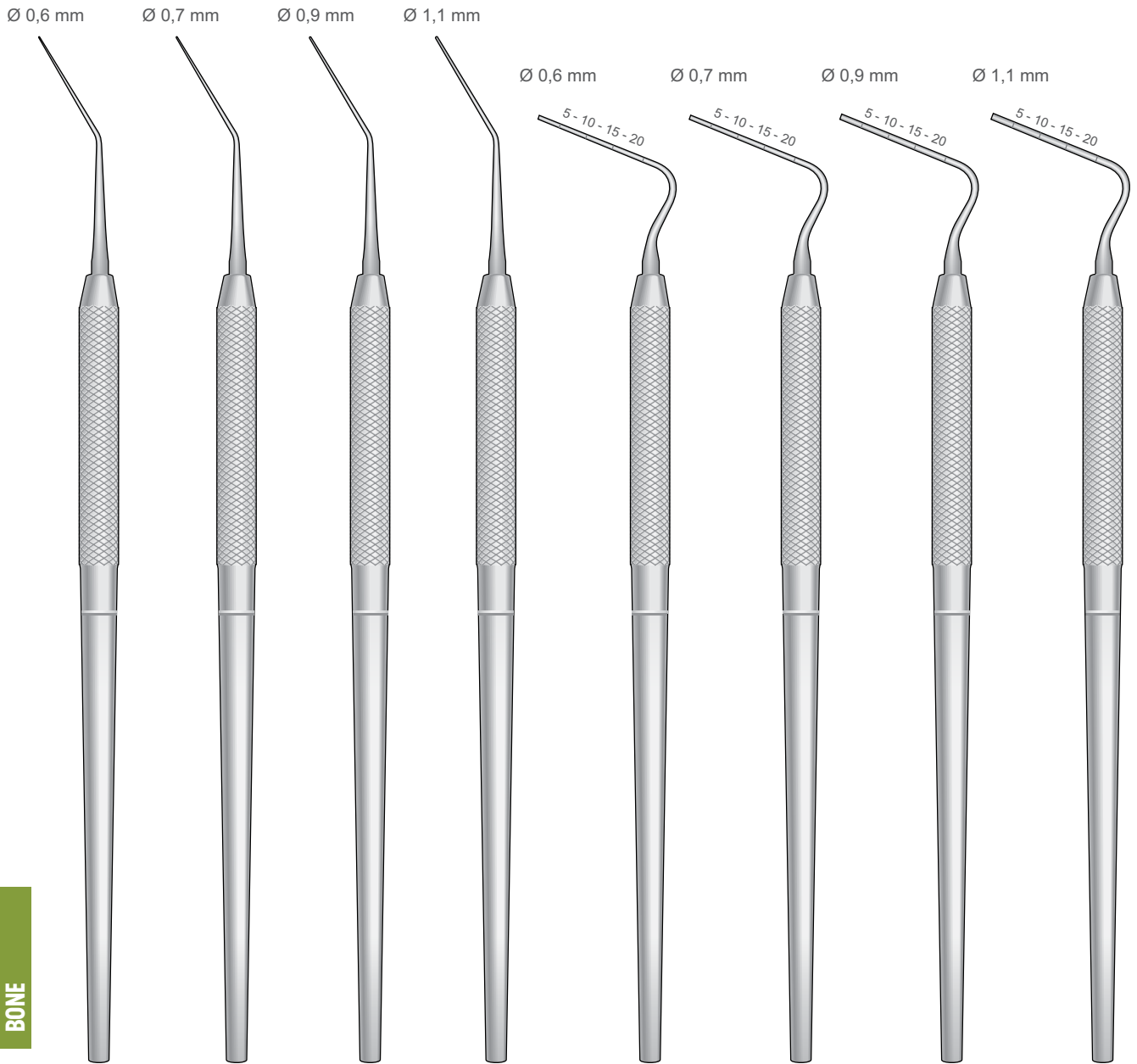
UNIVERSITY  
OF MICHIGAN  
SM-5

26 G  
SM-6

Flat  
Flach  
Plan  
Plano  
Piatto

PERIOSTEALS  
CURETTES &  
BONE





LUKS  
 PL-1  
 Fig.1

LUKS  
 PL-2  
 Fig.2

LUKS  
 PL-3  
 Fig.3

LUKS  
 PL-4  
 Fig.4

PZ-1  
 Fig.1

PZ-2  
 Fig.2

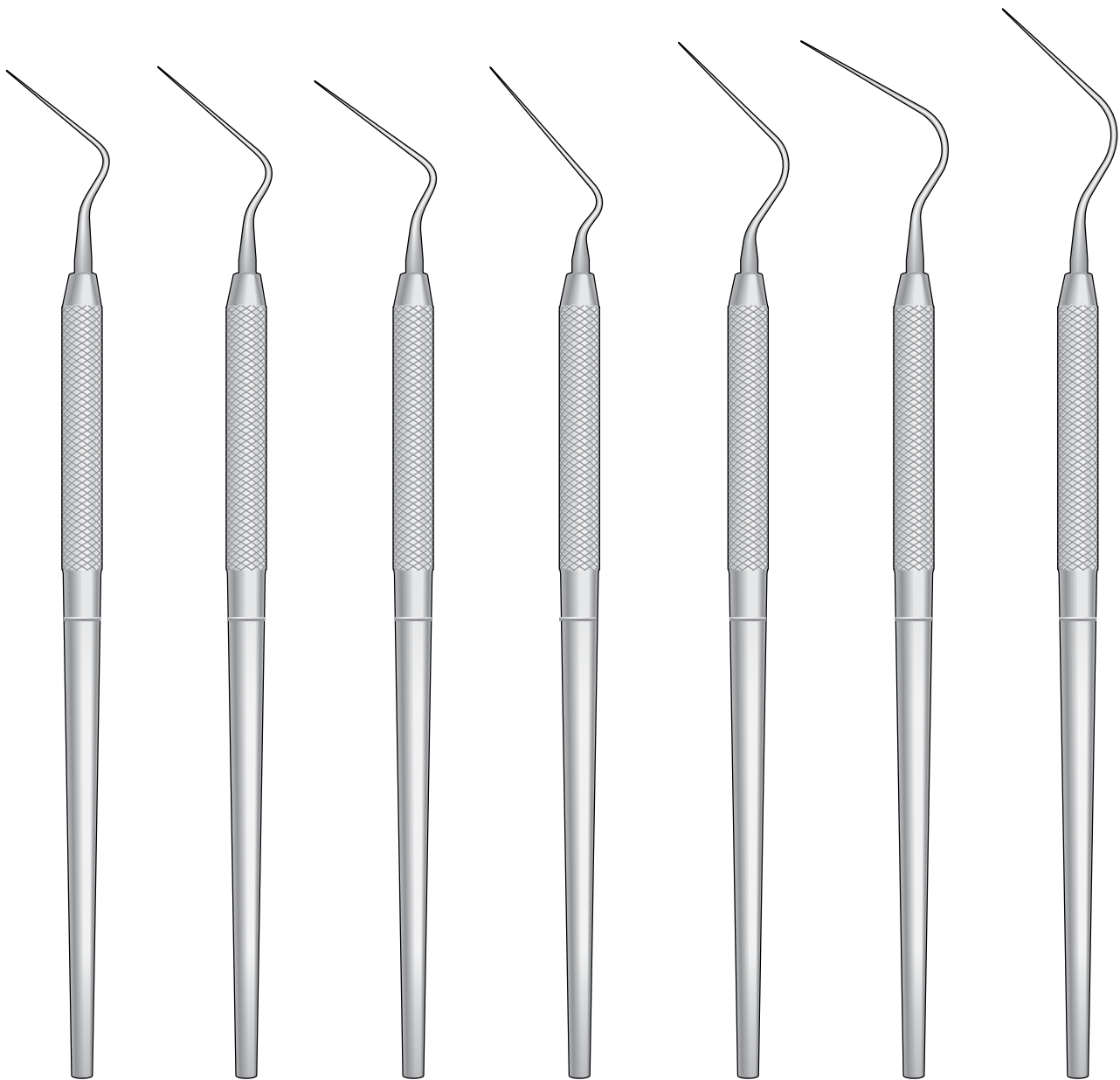
PZ-3  
 Fig.3

PZ-4  
 Fig.4

PERIOSTEALS  
 CURETTES &  
 BONE



Spreaders



**SP-1**  
Fig.1S

**SP-2**  
Fig.2S

**SP-3**  
Fig.D11

**SP-4**  
Fig.MA57

**SP-5**  
Fig.0

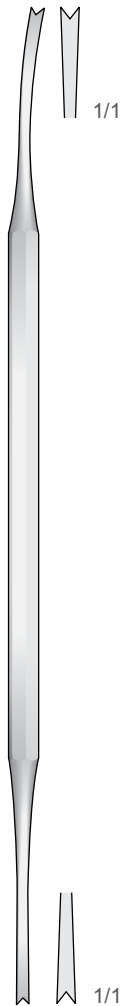
**SP-6**  
Fig.00

**SP-7**  
Fig.3

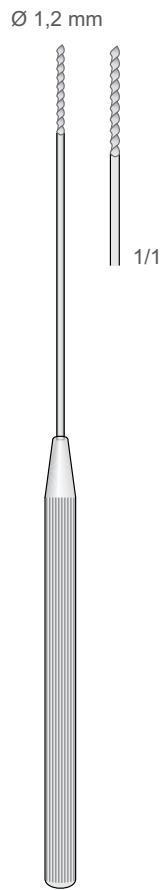
PERIOSTEALS  
CURETTES &  
BONE

Watteträger  
Cotton Applicators  
Porta cotone  
Portaalgodón  
Applicateur de coton

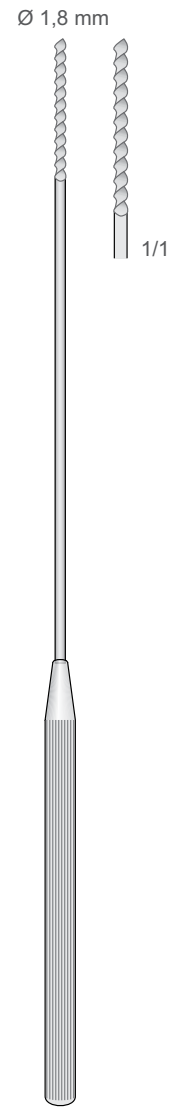
Tamponstopfer  
Gauze Packers  
Porta tamponi  
Portatampones  
Porte tampons



LUNIATSCHEK  
**PF-6**  
170 mm



UNIVERSAL  
**PF-40**  
140 mm



UNIVERSAL  
**PF-41**  
180 mm

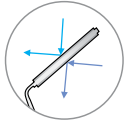
PERIOSTEALS  
CURETTES &  
BONE





Mundspiegel und Griffe  
 Mirrors and handles  
 Specchietti e manici  
 Espejos y mangos  
 Miroirs et manches

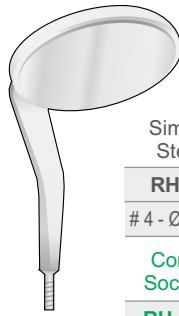
**DOUBLE SIDED FRONT SURFACE RHODIUM MIRROR**  
 Stainless steel - Rhodium coating



Reflecting surface is on **FRONT** of the glass.  
 Clear image. No distortion. No double/ghost image.

**Rhodium** coating for scratch resistance.  
 Enhanced indirect vision & illumination of dark areas.

Ergonomic & stream-lined design for less bulk.  
 +Visibility in any position: **2 opposite reflective faces**  
 (no need to turn the mirror to change from right to left).  
 Smoothly finished & retractor shaft design for patient comfort.



Box of 6

Simple Stem

**RH-14**

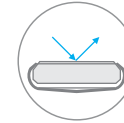
# 4 - Ø 22mm

Cone Socket

**RH-15A**

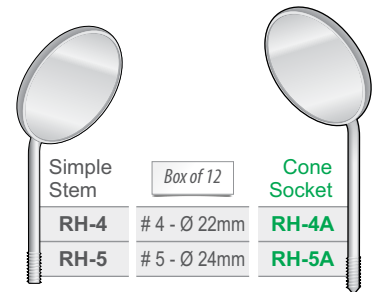
# 5 - Ø 24mm

**FRONT SURFACE RHODIUM MIRRORS**  
 Stainless steel - Rhodium coating



Reflecting surface is on **FRONT** of the glass.  
 Clear image. No distortion. No double/ghost image.

**Rhodium** coating for scratch resistance.  
 Enhanced indirect vision & illumination of dark areas.  
 Used for retraction of lips, cheeks and tongue.



Simple Stem

Box of 12

Cone Socket

**RH-4**

# 4 - Ø 22mm

**RH-4A**

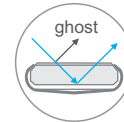
**RH-5**

# 5 - Ø 24mm

**RH-5A**

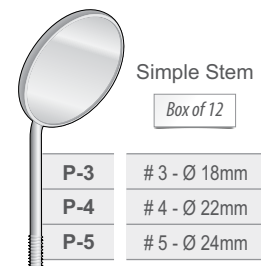
**PLANE MIRRORS**

Stainless steel - Aluminium coating



Re ecting surface is on **REAR** of the glass.  
 Aluminium coating. Good image quality.  
 Flat mirror produce double/ghost image.

**Low-cost.**



Simple Stem

Box of 12

**P-3**

# 3 - Ø 18mm

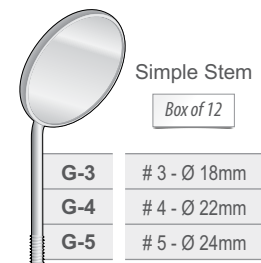
**P-4**

# 4 - Ø 22mm

**P-5**

# 5 - Ø 24mm

Concave with enlarging effect



Simple Stem

Box of 12

**G-3**

# 3 - Ø 18mm

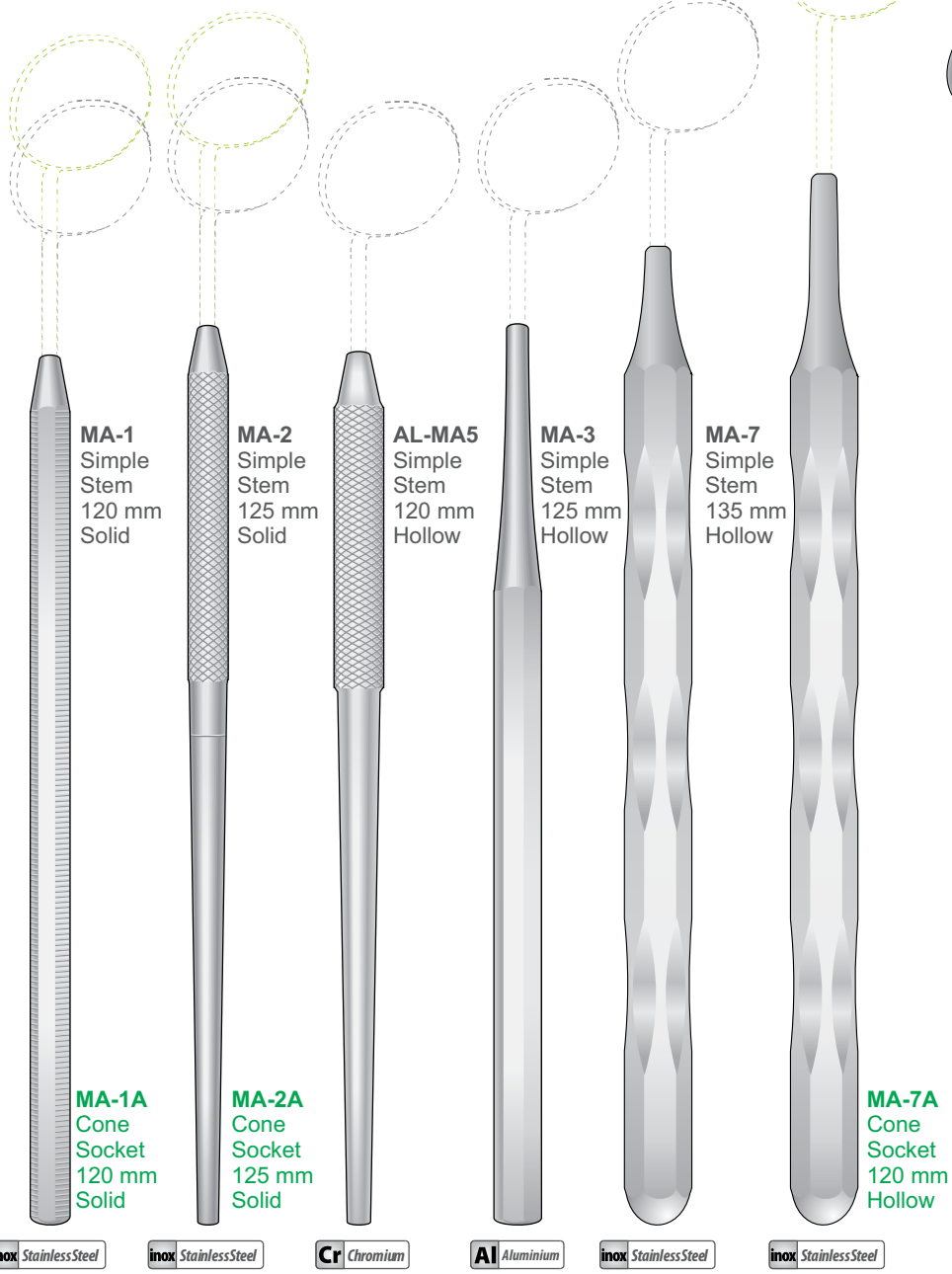
**G-4**

# 4 - Ø 22mm

**G-5**

# 5 - Ø 24mm

**PERIOSTEALS  
 CURETTES &  
 BONE**



**MA-1**  
 Simple Stem  
 120 mm  
 Solid

**MA-2**  
 Simple Stem  
 125 mm  
 Solid

**AL-MA5**  
 Simple Stem  
 120 mm  
 Hollow

**MA-3**  
 Simple Stem  
 125 mm  
 Hollow

**MA-7**  
 Simple Stem  
 135 mm  
 Hollow

**MA-1A**  
 Cone Socket  
 120 mm  
 Solid

**MA-2A**  
 Cone Socket  
 125 mm  
 Solid

**MA-7A**  
 Cone Socket  
 120 mm  
 Hollow

**inox** StainlessSteel

**inox** StainlessSteel

**Cr** Chromium

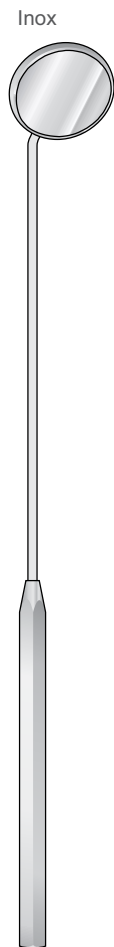
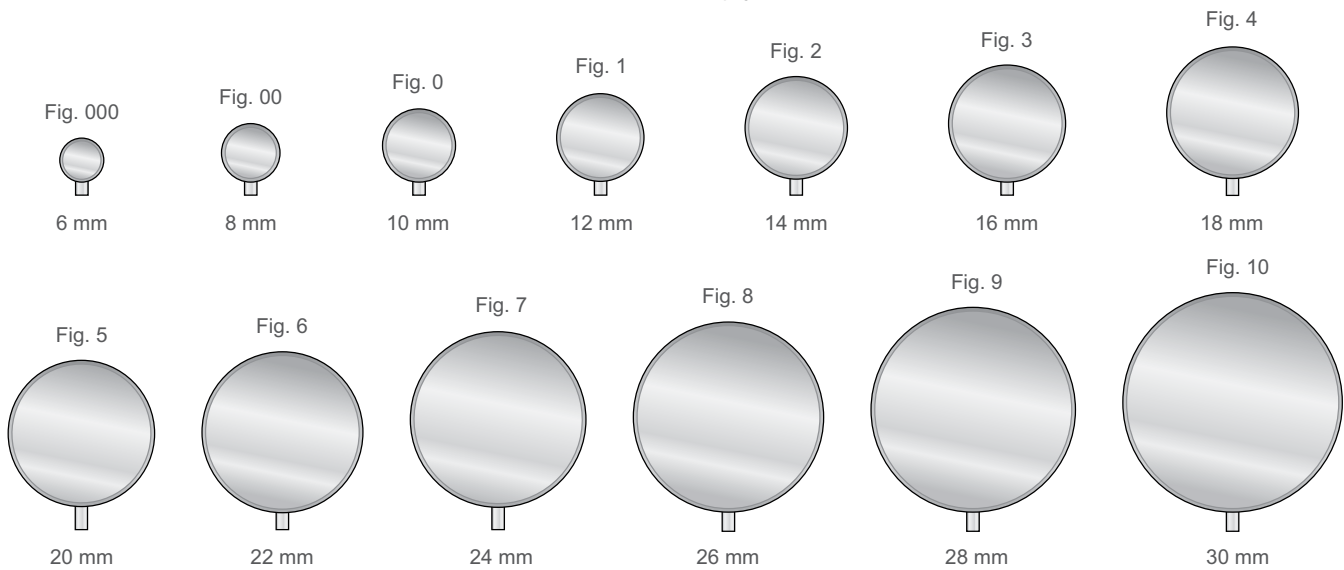
**Al** Aluminium

**inox** StainlessSteel

**inox** StainlessSteel



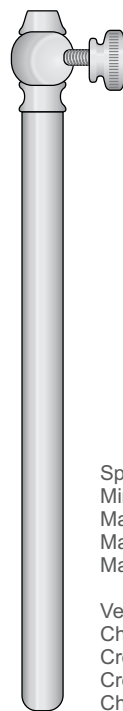
Spiegeldurchmesser - Diameter of mirrors  
Diametro dello specchio - Diamètre des miroirs  
Diámetro de los espejos



Kehlkopfspiegel mit  
Sechskantgriff  
Laryngeal mirrors  
with hexagonal handle  
Specchietto laringeo  
con manico esagonale  
Espejo laringeo  
con mango hexagonal  
Miroirs laryngiens  
avec manche hexagonal

- G-8 Fig. 00
- G-10 Fig. 0
- G-12 Fig. 1
- G-14 Fig. 2
- G-16 Fig. 3
- G-18 Fig. 4
- G-20 Fig. 5
- G-22 Fig. 6
- G-24 Fig. 7
- G-26 Fig. 8
- G-28 Fig. 9
- G-30 Fig. 10

**G-8/G-30**  
180 mm



Spiegelgriff  
Mirrors handle  
Manico per specchietti  
Mango para espejos  
Manche à miroir

Verchromt  
Chromium  
Cromato  
Cromado  
Chromé

**MA-6**  
120 mm

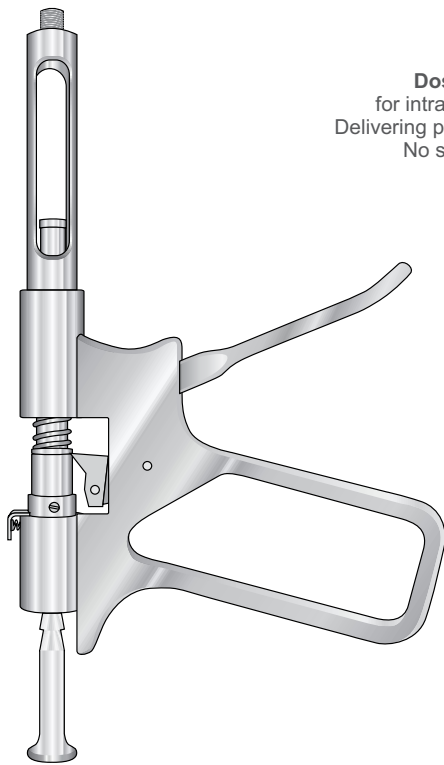


Kehlkopfspiegel  
Laryngeal mirrors  
Specchietto laringeo  
Espejos laryngeos  
Miroirs laryngiens

- P-000 Fig. 000
- P-00 Fig. 00
- P-0 Fig. 0
- P-01 Fig. 1
- P-02 Fig. 2
- P-03 Fig. 3
- P-04 Fig. 4
- P-05 Fig. 5
- P-06 Fig. 6

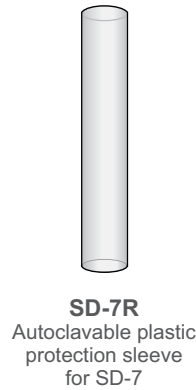
**P-000/P-06**  
120 mm

Dental-Spritzen  
 Dental Syringes  
 Siringhe dentali  
 Jeringas dentales  
 Seringues dentaires

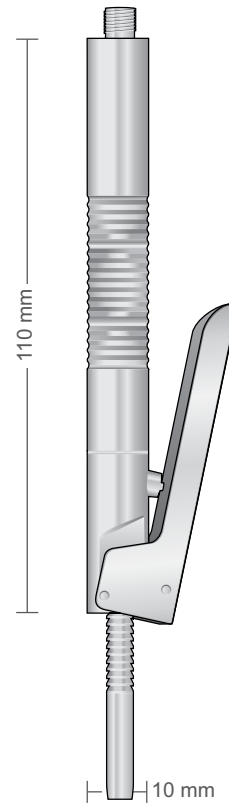


**Dosing Lever Syringe**  
 for intraligamentary anesthesia.  
 Delivering precisely 0.2 ml of anesthetic.  
 No soft-tissue numbness.

- SD-7**  
Imperial Tip  
1.8 ml
- SD-7M**  
Metric Thread  
1.8 ml
- SD-9NA**  
Imperial Tip  
1.8 ml  
*(Sold only in North America)*



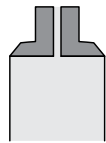
**SD-7R**  
 Autoclavable plastic protection sleeve for SD-7



**Pen-style Syringe**  
 for intraligamentary anesthesia

- SD-20**  
Imperial Tip  
1.8 ml
- SD-20M**  
Metric Thread  
1.8 ml

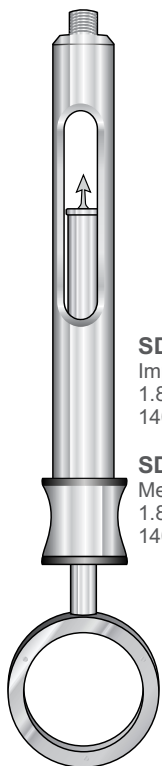
**Aspirating Anesthetic Syringe**



Aspirating syringes feature a blunt harpoon rod.

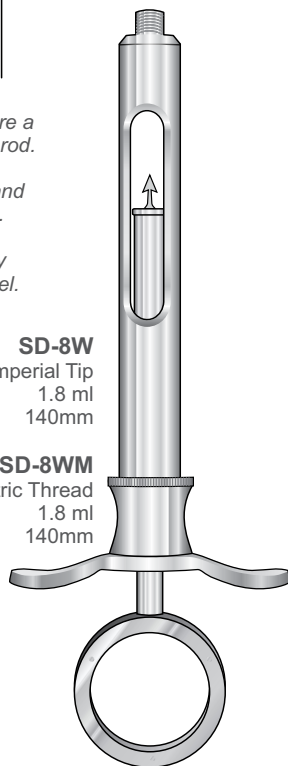
Lightweight and Ergonomic.

High quality stainless steel.



**SD-8**  
Imperial Tip  
1.8 ml  
140mm

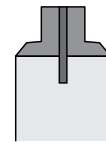
**SD-8M**  
Metric Thread  
1.8 ml  
140mm



**SD-8W**  
Imperial Tip  
1.8 ml  
140mm

**SD-8WM**  
Metric Thread  
1.8 ml  
140mm

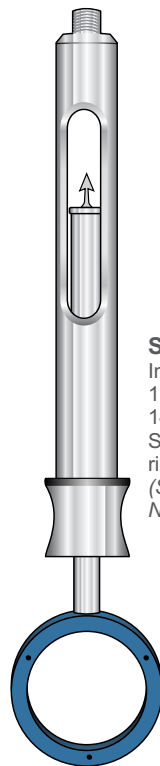
**Aspirating and Self Aspirating Anesthetic Syringe**



Self-aspirating mechanism allows to aspirate by means of counter pressure.

Lightweight and Ergonomic.

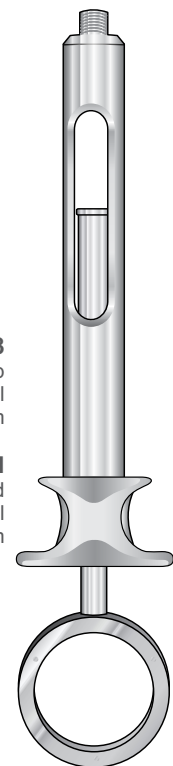
High quality stainless steel.



**SD-8NA**  
Imperial Tip  
1.8 ml  
140mm  
Silicone covered ring handle  
*(Sold only in North America)*

Silicone covered ring handle

**Self Aspirating Anesthetic Syringe**



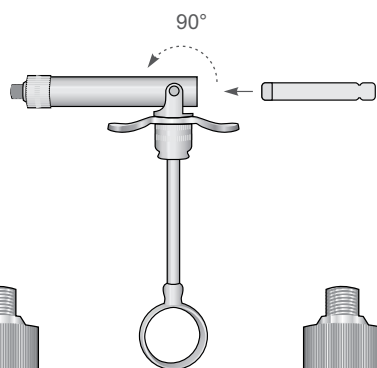
**SD-88**  
Imperial Tip  
1.8 ml  
140mm

**SD-88M**  
Metric Thread  
1.8 ml  
140mm

**PERIOSTEALS  
 CURETTES &  
 BONE**



Zylinder-Ampullen Spritzen  
 Cartridge Syringes  
 Siringhe per tubofiale  
 Jeringas de ampollas  
 Seringues d'ampoules



Aufsatz  
 Spare cap only  
 Adattatore solo  
 Adaptador suelto  
 Embout seul

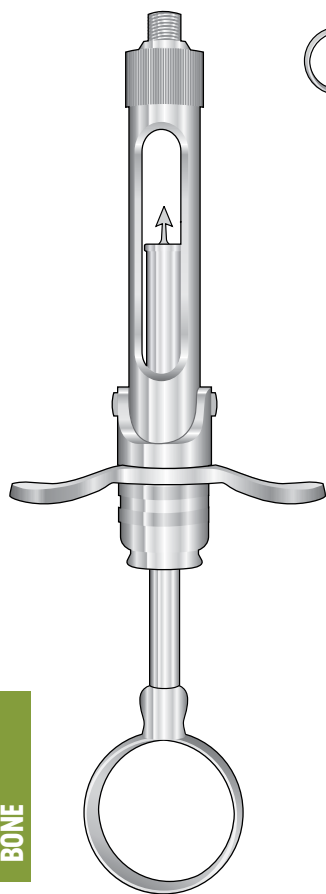


SD-3R

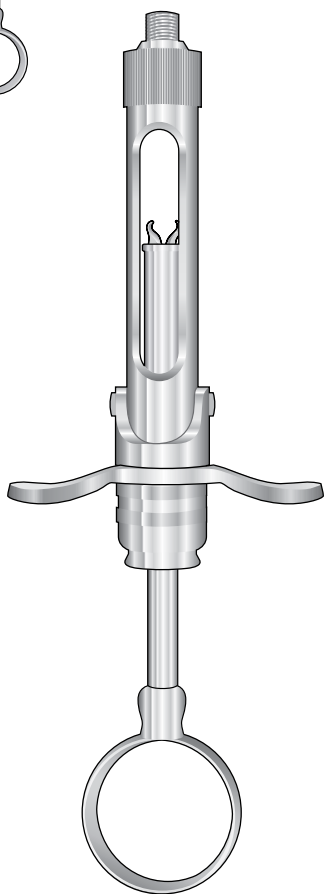
Aufsatz  
 Spare cap only  
 Adattatore solo  
 Adaptador suelto  
 Embout seul



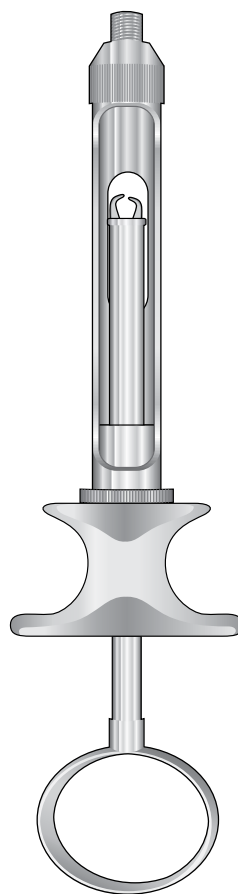
STF-1R



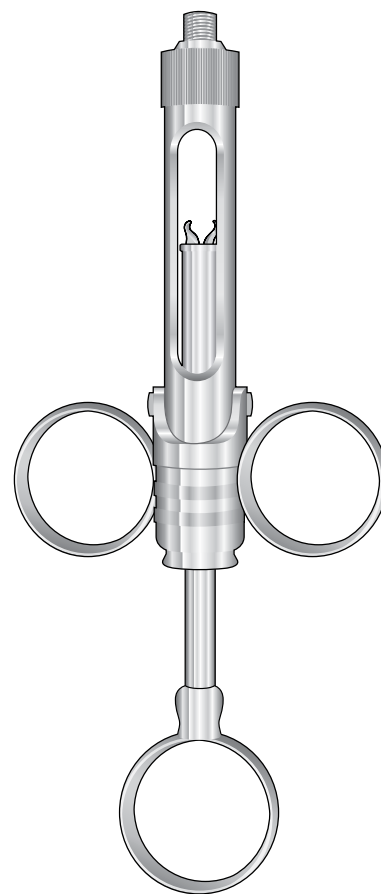
SD-1



SD-2



SD-3



STF-1  
 130 mm

PERIOSTEALS  
 CURETTES &  
 BONE



Küretten  
Curettes  
Curette  
Curetas  
Curettes

# Curettes and Scalers



GRACEY  
CU-1/2



GRACEY  
CU-3/4



GRACEY  
CU-5/6



GRACEY  
CU-7/8



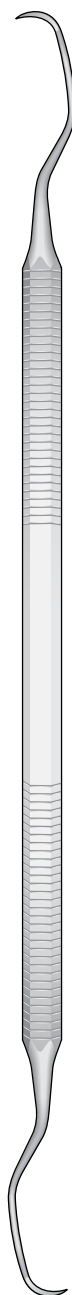
GRACEY  
CU-9/10



GRACEY  
CU-11/12



GRACEY  
CU-13/14



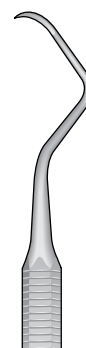
LANGER Fig.1/2  
COL-1/2



LANGER Fig.3/4  
COL-3/4



COLUMBIA  
COL-2RL



COLUMBIA  
COL-4RL



COLUMBIA  
COL-13/14

PERIOSTEALS  
CURETTES &  
BONE



# Elite

Scalers and Curettes  
 Scalers and Curettes  
 Scaler e Curette  
 Raspadores y Curetas  
 Détartreurs et Curettes

**Elite**  
 Invar Stainless Steel

**Curettes**  
 Universal Tip 90°  
 Gracey Tip 70°  
 Cutting Edges

**Scalers**  
 Curved Blade  
 Tip 50°  
 Straight Blade  
 Cutting Edges

Balanced and ergonomic for great tactile working ability. Maintains long sharp edges.  
 Extra light hollow handle for optimum comfort (feather weight / round Ø 9 mm).

Ausgewogen und ergonomisch für eine gute Anwendbarkeit.  
 Dauerhafte scharfe Ecken. Extra leichte Hohlgriffe für optimale Komfort (Federleicht).

Équilibrés et ergonomiques pour une plus grande habileté tactile. Bords tranchants durables. Manche extra léger et creux pour un confort optimal (poids plume).

Bilanciata ed ergonomiche per una maggiore facilità di lavoro. Bordi taglienti durevoli. Impugnatura cava, extra leggera, per un comfort ottimale (peso piuma).

**Gracey Hygiene Chart**

Anterior, Posterior, Molars, Premolars (bicuspid), Canines (cuspids), Incisors, Incisors, Canines (cuspids), Premolars (bicuspid), Molars, Posterior

● Anterior: 1/2, 3/4, 5/6 ● Buccal Lingual Surfaces: 7/8, 9/10 ● Mesial Surfaces Premolars, Molars: 11/12, 15/16 ● Distal Surfaces Premolars, Molars: 13/14, 17/18

Also available: **ET**: Extra-Thin (micro), **S**: Small (mini S) and **L**: Long (alter S)



**USG-1/2ET**  
 Gracey  
 Curette 1/2ET



**USG-3/4ET**  
 Gracey  
 Curette 3/4ET



**USG-5/6ET**  
 Gracey  
 Curette 5/6ET



**USG-7/8ET**  
 Gracey  
 Curette 7/8ET



**USG-9/10ET**  
 Gracey  
 Curette 9/10ET



**USG-11/12ET**  
 Gracey  
 Curette 11/12ET



**USG-13/14ET**  
 Gracey  
 Curette 13/14ET



**USG-15/16ET**  
 Gracey  
 Curette 15/16ET

PERIOSTEALS  
 CURETTES &  
 BONE





**USG-1/2**  
 Gracey  
 Curette 1/2



**USG-3/4**  
 Gracey  
 Curette 3/4



**USG-5/6**  
 Gracey  
 Curette 5/6



**USG-7/8**  
 Gracey  
 Curette 7/8



**USG-9/10**  
 Gracey  
 Curette 9/10



**USG-11/12**  
 Gracey  
 Curette 11/12



**USG-13/14**  
 Gracey  
 Curette 13/14



**USG-1/2S**  
 Gracey  
 Curette 1/2S



**USG-3/4S**  
 Gracey  
 Curette 3/4S



**USG-5/6S**  
 Gracey  
 Curette 5/6S



**USG-7/8S**  
 Gracey  
 Curette 7/8S



**USG-9/10S**  
 Gracey  
 Curette 9/10S



**USG-11/12S**  
 Gracey  
 Curette 11/12S



**USG-13/14S**  
 Gracey  
 Curette 13/14S



**PERIOSTEALS  
 CURETTES &  
 BONE**



PERIOSTEALS  
 CURETTES &  
 BONE







**USS-NV0**  
 Nevi  
 Scaler  
 NV0



**USS-NV11/12**  
 Nevi  
 Scaler  
 NV11/12



**USS-NV13/14**  
 Nevi  
 Scaler  
 NV13/14



**USS-T2/3**  
 Taylor  
 Scaler  
 2/3



**USS-204S**  
 Scaler  
 204S



**USS-H6/7**  
 Scaler  
 H6/H7



**USS-15/33**  
 Towner-Jaquette  
 Scaler  
 U15/J33



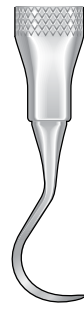
**USS-5/33**  
 Jaquette  
 Scaler  
 H5/J33



**USS-15/30**  
 Towner-Jaquette  
 Scaler  
 U15/J30



**USS-J14/15**  
 Jaquette  
 Scaler  
 J14/15



PERIOSTEALS  
 CURETTES &  
 BONE

**Elite TITANIUM**

Long lasting solid titanium tip. Designed for removing calculus on implants surfaces. Gold coloured handle for easy identification purposes so they won't be mixed up with standard stainless instruments (feather weight / round Ø 9 mm).

Universal Tip 90°  
Gracey Tip 70°  
Cutting Edges

Curved Blade  
Scalers  
Tip 90°  
Straight Blade  
Cutting Edges

Massivem Titan-Spitzen, die sie extrem widerstandsfähig und langlebig sind. Entwickelt für die Entfernung von Zahnbelag auf Implantat-Oberflächen. Vergoldete Griffe für eine einfache Kennzeichnung, damit sie von Standardinstrumenten unterschieden werden können (Federleicht).

Puntas de titanio sólido más resistentes y durables. Diseñadas para eliminar el sarro en los implantes de titanio. Mangos dorados para una mejor identificación, el cual evita la confusión con los instrumentos de acero inoxidable estándar (peso pluma).

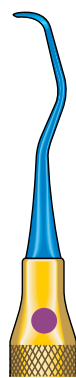
Punte in titanio solido più resistente e durevole. Progettate per la rimozione di tartaro dalle superfici degli impianti. Manico color oro per un riconoscimento semplice e per evitare di essere confuse con i strumenti in acciaio (peso piuma).

**Gracey Hygiene Chart**

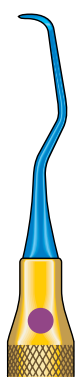
Anterior: 1/2, 3/4, 5/6  
Buccal/Lingual Surfaces: 7/8, 9/10  
Mesial Surfaces Premolars, Molars: 11/12, 15/16  
Distal Surfaces Premolars, Molars: 13/14, 17/18



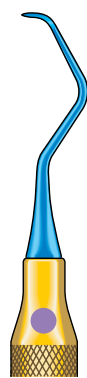
PERIOSTEALS  
CURETTES &  
BONE



**T-USG-1/2**  
Gracey  
Curette 1/2



**T-USG-5/6**  
Gracey  
Curette 5/6



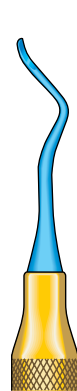
**T-USG-7/8**  
Gracey  
Curette 7/8



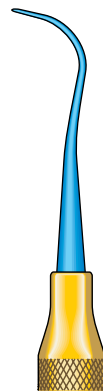
**T-USG-11/12**  
Gracey  
Curette 11/12



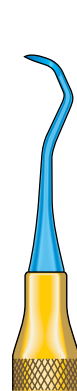
**T-USG-13/14**  
Gracey  
Curette 13/14



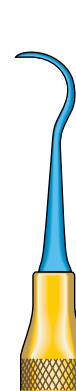
**T-USS-B5/6**  
Barnhart  
Curette 5/6



**T-USS-YG7/8**  
Younger-Good  
Curette YG 7/8



**T-USS-204S**  
Scaler 204S



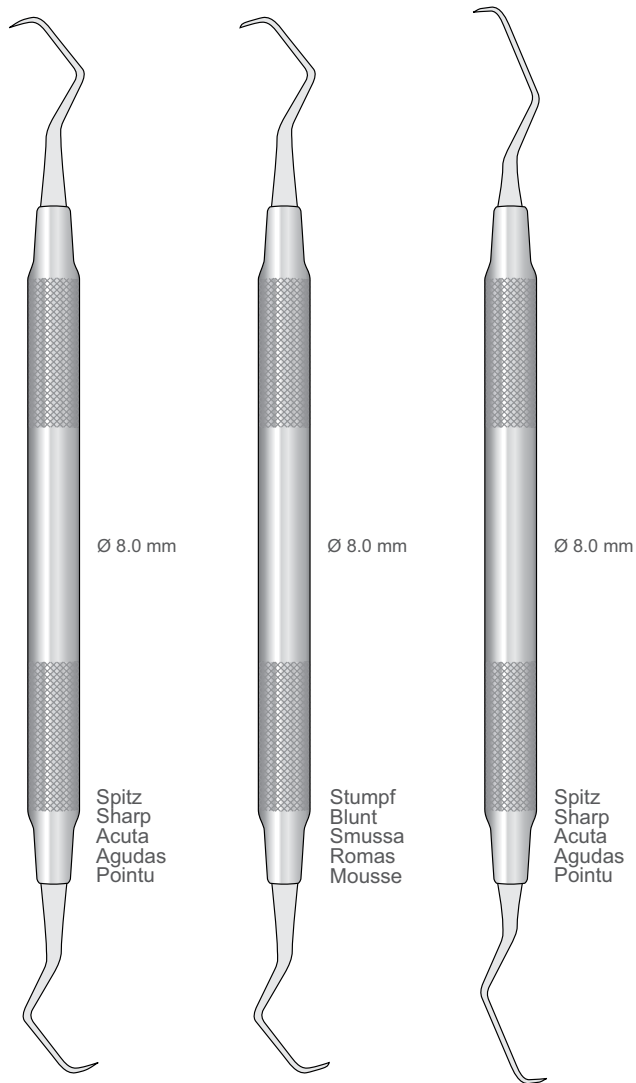
**T-USS-G6/7**  
Scaler G6/G7

⚠ Use a dedicated sharpening stone for Titanium Scalers & Curettes.

Curettes - Files  
 Curette - Lime  
 Curetasc - Lima  
 Curettes - Limes

Universal Küretten  
 Universal Curettes  
 Curette universali  
 Curetas universales  
 Curettes universelles

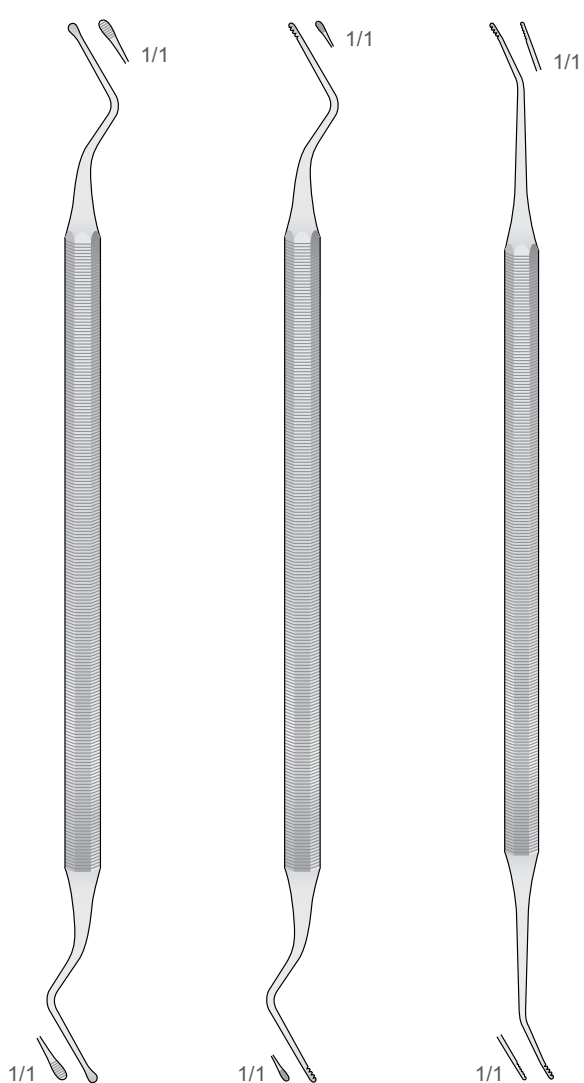
Parodontalfeilen  
 Periodontal Files  
 Lime parodontali  
 Limas parodontales  
 Limes parodontales



**718-M23**  
165 mm

**718-M23A**  
165 mm

**718-M23B**  
170 mm



**HIRSCHFELD HF-3/7**  
170 mm

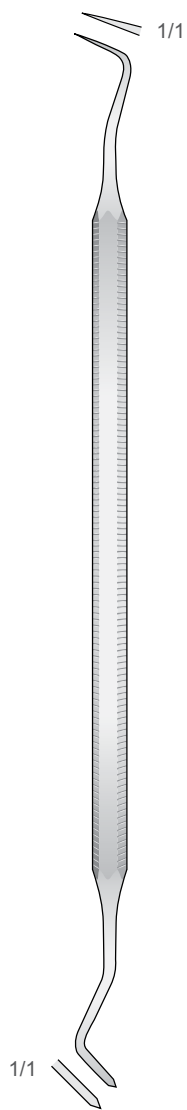
**HIRSCHFELD HF-5/11**  
170 mm

**HIRSCHFELD HF-9/10**  
175 mm

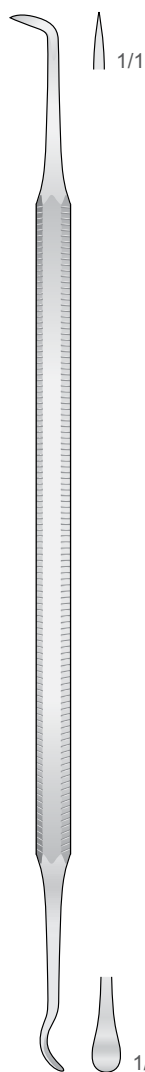
PERIOSTEALS  
 CURETTES &  
 BONE



PERIOSTEALS  
CURETTES &  
BONE



LANGE  
PF-9  
160 mm



MITCHEL  
AT-12  
170 mm

Scalers



AT-1



AT-2R



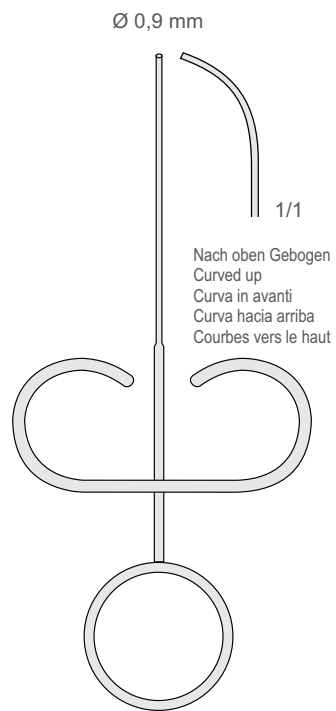
AT-2L



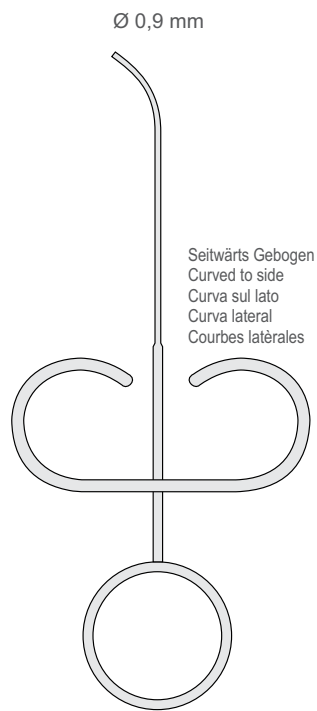
AT-6



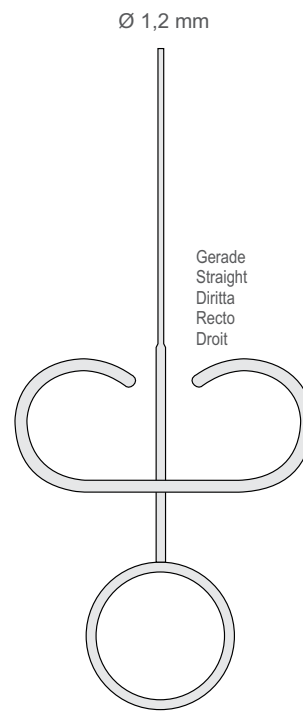
Amalgam gun for retrograde  
 Siringhe portamalgama retrogradi  
 Portaamalgama para retrógradas  
 Porte-amalgame pour rétrogrades



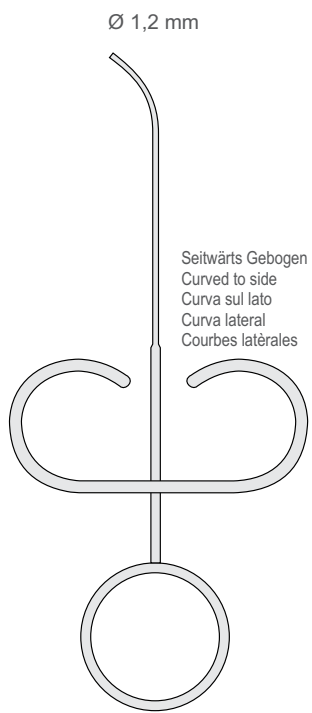
**SS-51**  
130 mm



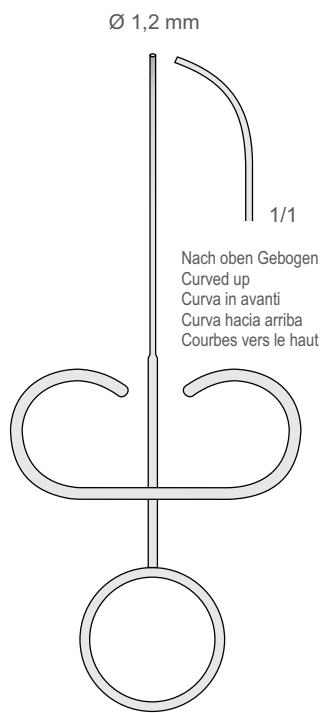
**SS-55**  
130 mm



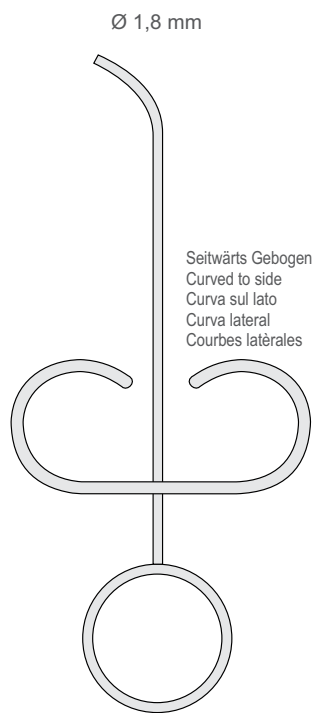
**SS-54**  
130 mm



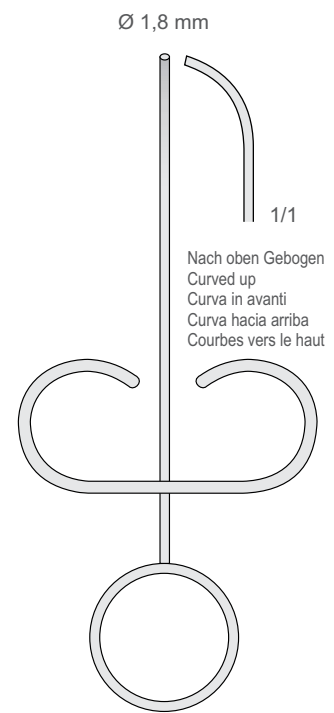
**SS-56**  
130 mm



**SS-58**  
130 mm



**SS-50**  
130 mm



**SS-52**  
130 mm

PERIOSTEALS  
 CURETTES &  
 BONE



Amalgamträger  
Amalgam Carriers  
Porta amalgama  
Porta-amalgamas  
Porte-amalgames

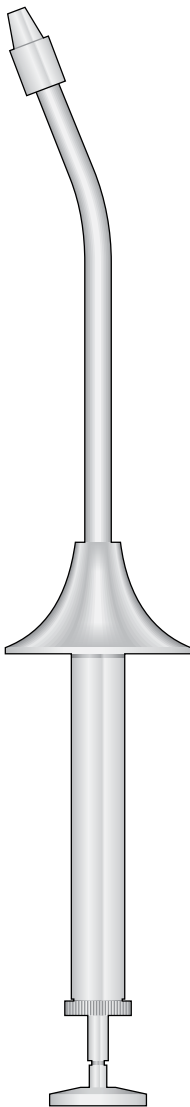
inox StainlessSteel

Amalgambecher  
Amalgam Well  
Mortajo per amalgama  
Vaso para amalgama  
Gobelet pour amalgame

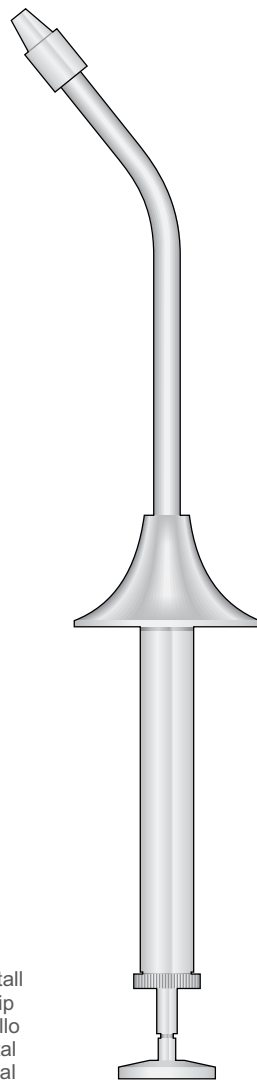


Knochenschale  
Bone Well  
Bacinella per osso  
Cubeta para hueso  
Cuvette à os

**SS-65**  
Ø 35 x 35mm  
depht 15 mm  
5cc - 0.17oz

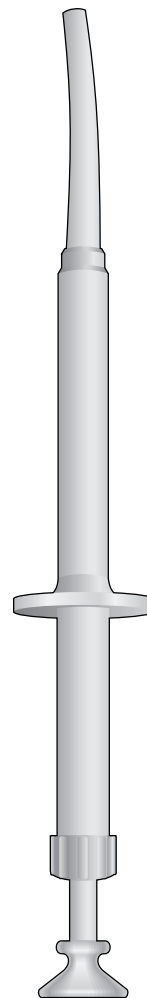


**SS-15**



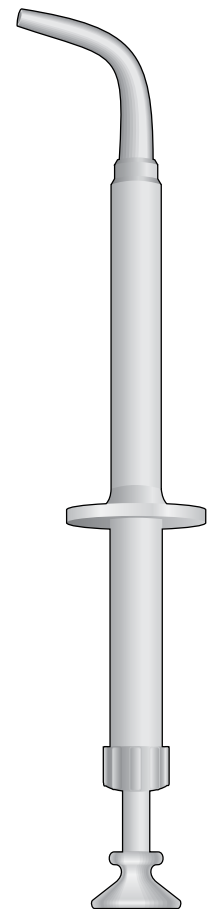
**SS-16**

Aus Metall  
Metal tip  
In metallo  
De metal  
En métal



**SS-41**  
170 mm

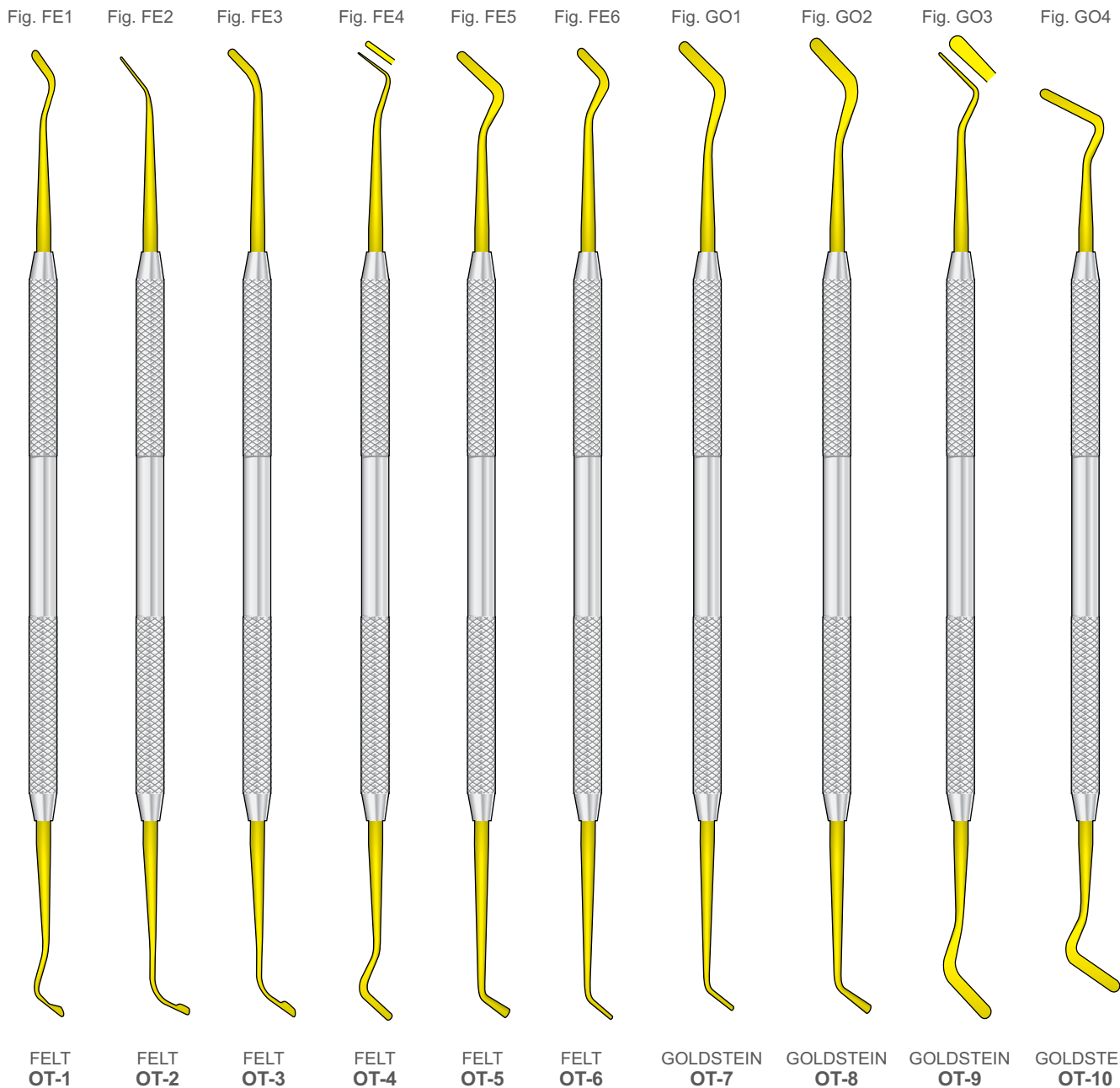
Autoclavable  
Aus Kunststoff  
Plastic tip  
In plastica  
De plàstico  
En plastique



**SS-42**  
160 mm

PERIOSTEALS  
CURETTES &  
BONE





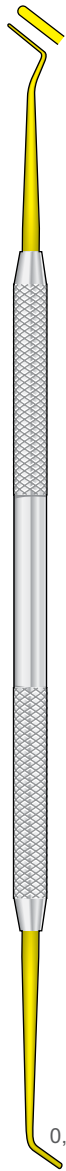
PERIOSTEALS  
 CURETTES &  
 BONE





Titanium-coated  
Titan-beschichtet  
Recouvrement en Titane  
Recubrimiento de Titanio  
Ricoperto in Titanio

Fig. CP1  
1,5 mm



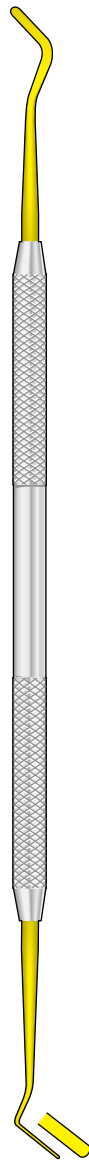
OT-11

Fig. CP2  
2,0 mm



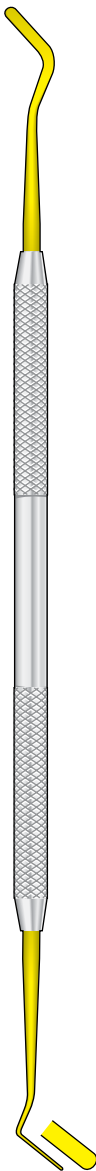
OT-12

Fig. CP3  
2,0 mm



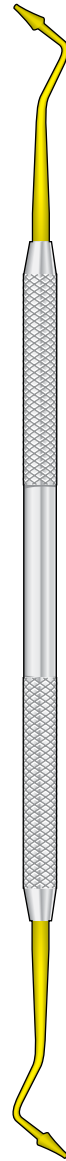
OT-13

Fig. CP4  
2,5 mm



OT-14

Fig. CP5



OT-15

Fig. CP6



OT-16

PERIOSTEALS  
CURETTES &  
BONE

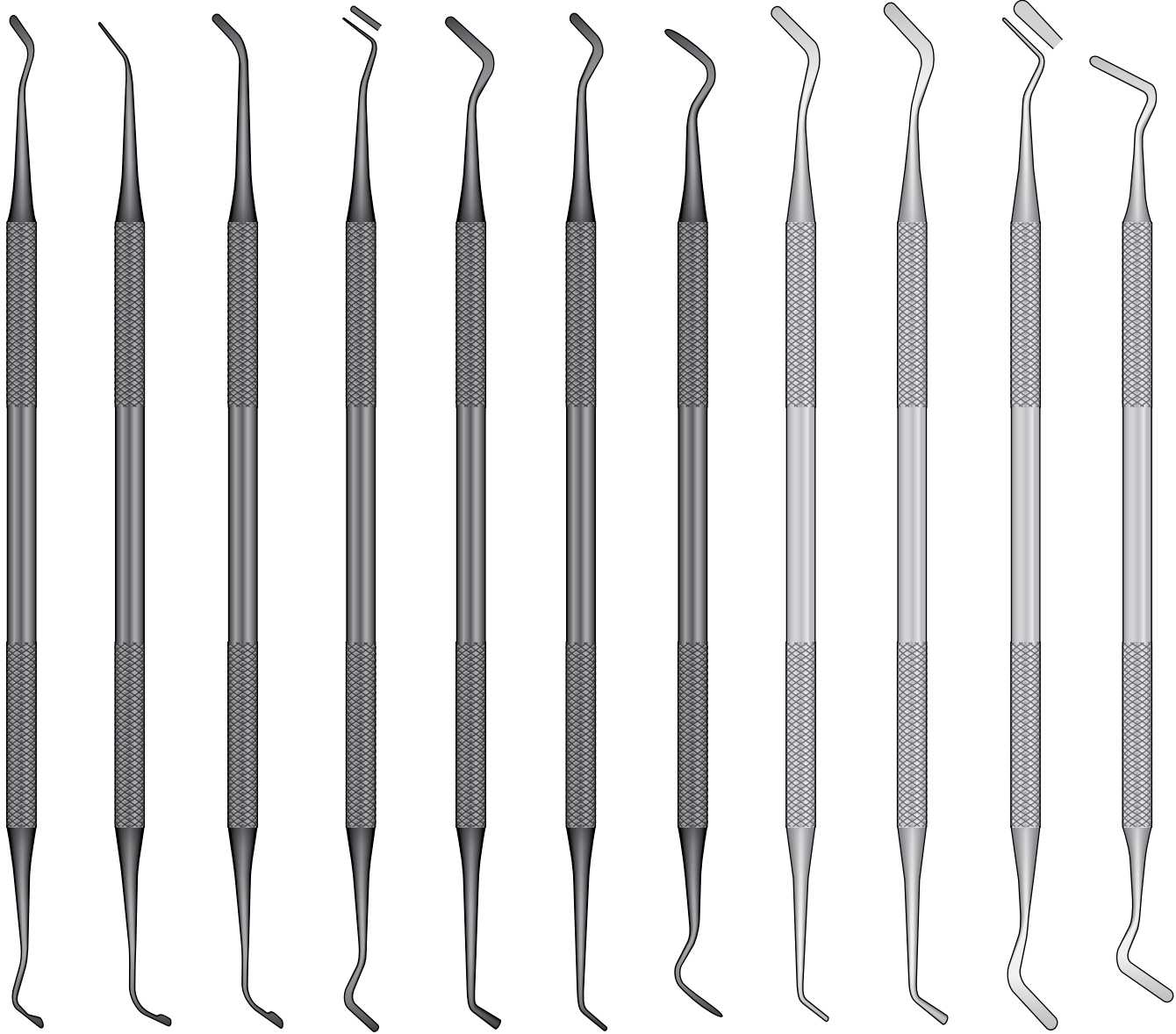






FELT

GOLDSTEIN



FE-1

FE-2

FE-3

FE-4

FE-5

FE-6

FE-4/5

GO-1

GO-2

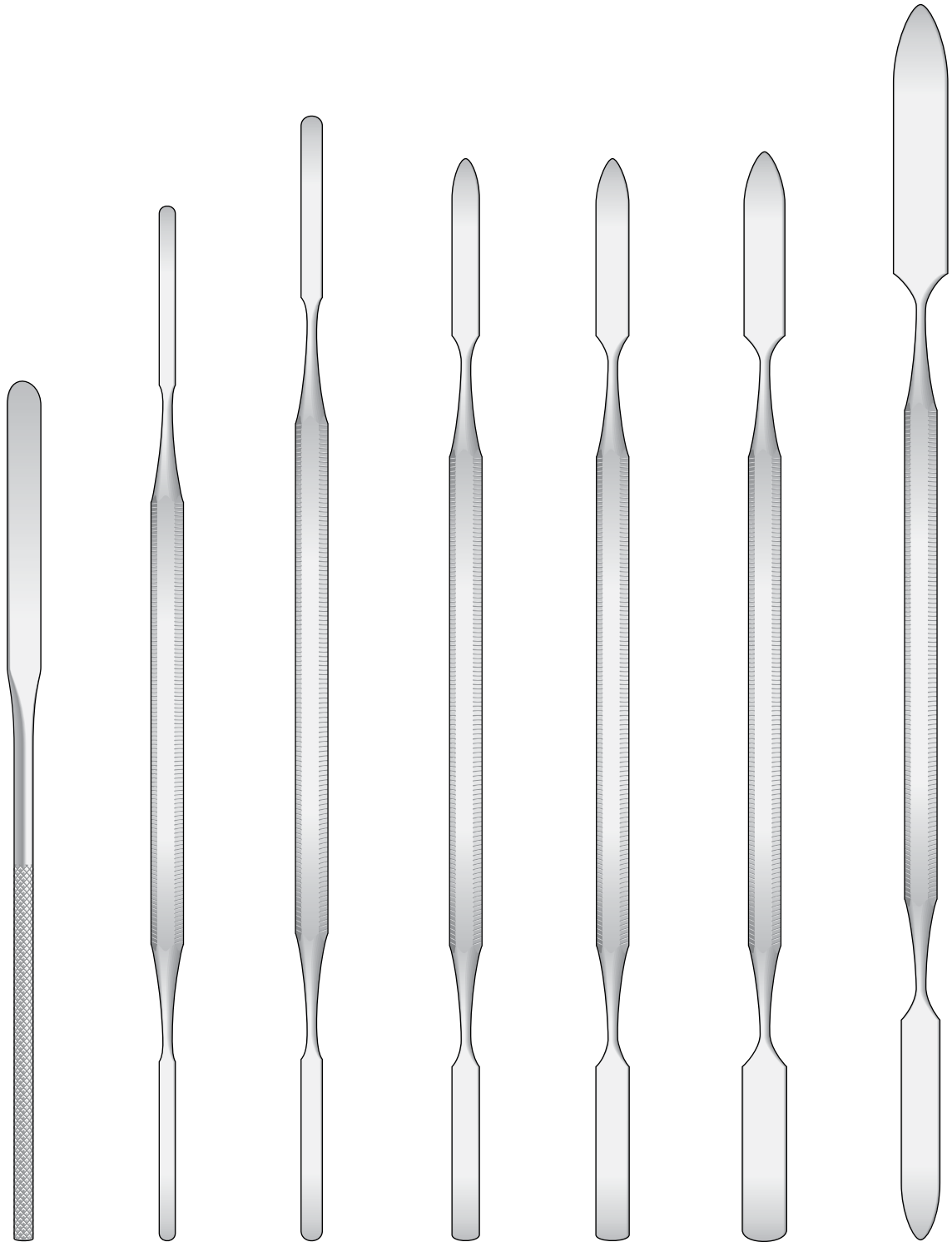
GO-3

GO-4

PERIOSTEALS  
CURETTES &  
BONE



Zementspatel  
Cement Spatulas  
Spatole per cemento  
Espátulas para cemento  
Spatules à ciment



**SR**  
140 mm

**S-00**  
180 mm

**S-0**  
185 mm

**S-1**  
180 mm

**S-2**  
180 mm

**S-3**  
180 mm

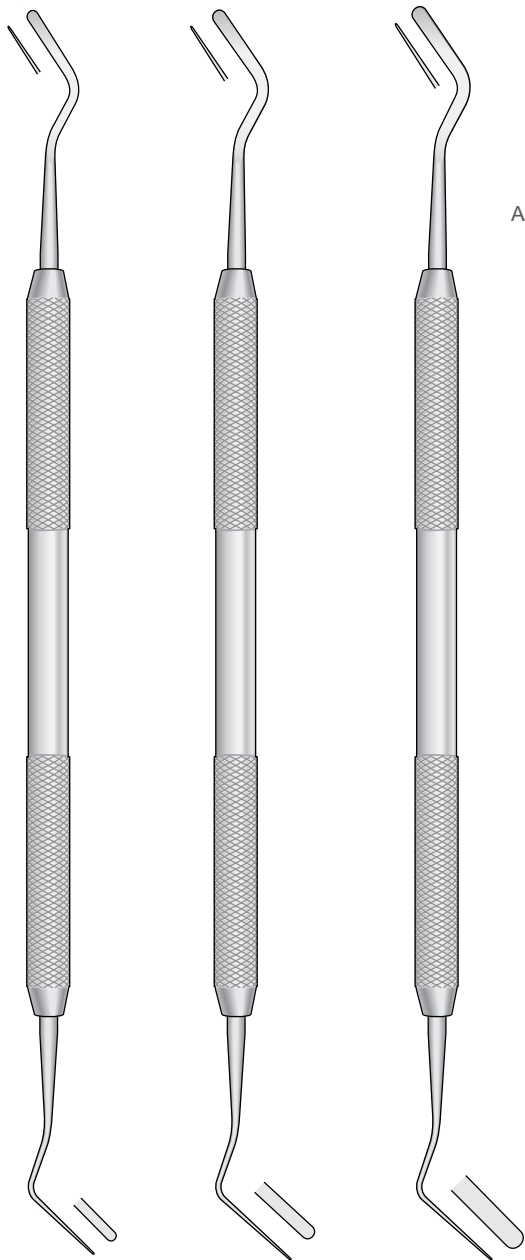
**S-4**  
200 mm

PERIOSTEALS  
CURETTES &  
BONE



Füllungsinstrumente  
 Filling Instruments  
 Strumenti per otturazione  
 Instrumentos para obturación  
 Instruments pour obturation

Heidemann-Spateln  
 Heidemann Spatulas  
 Spatole Heidemann  
 Espátulas Heidemann  
 Spatules Heidemann



**H-1**  
Fig. 1

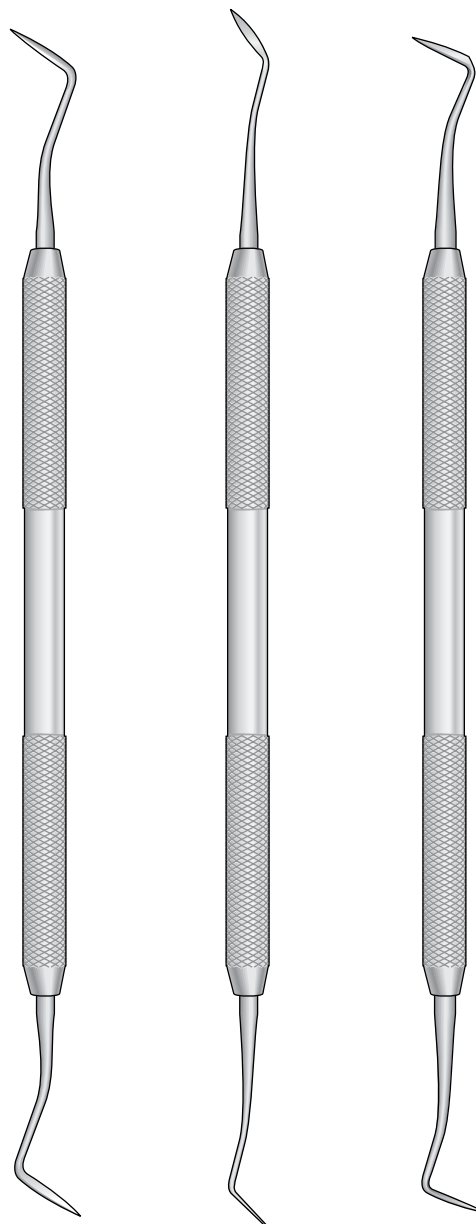
**H-2**  
Fig. 2

**H-3**  
Fig. 3

**A-1**  
125 mm

Dycal Applikator  
 Placement Instrument  
 Applicatore per sottofondo  
 Aplicadores de fondo  
 de cavidades  
 Applicateur de fond  
 de cavité

Amalgam Instrumente  
 Amalgam Carvers  
 Strumenti per modellare l'amalgama  
 Instrumentos para modelar las obturaciones  
 Instruments à modeler l'amalgame



**R-1**  
HOLLENBACH  
# 1 - 165 mm

**R-2**  
HOLLENBACH  
# 1/2 - 165 mm

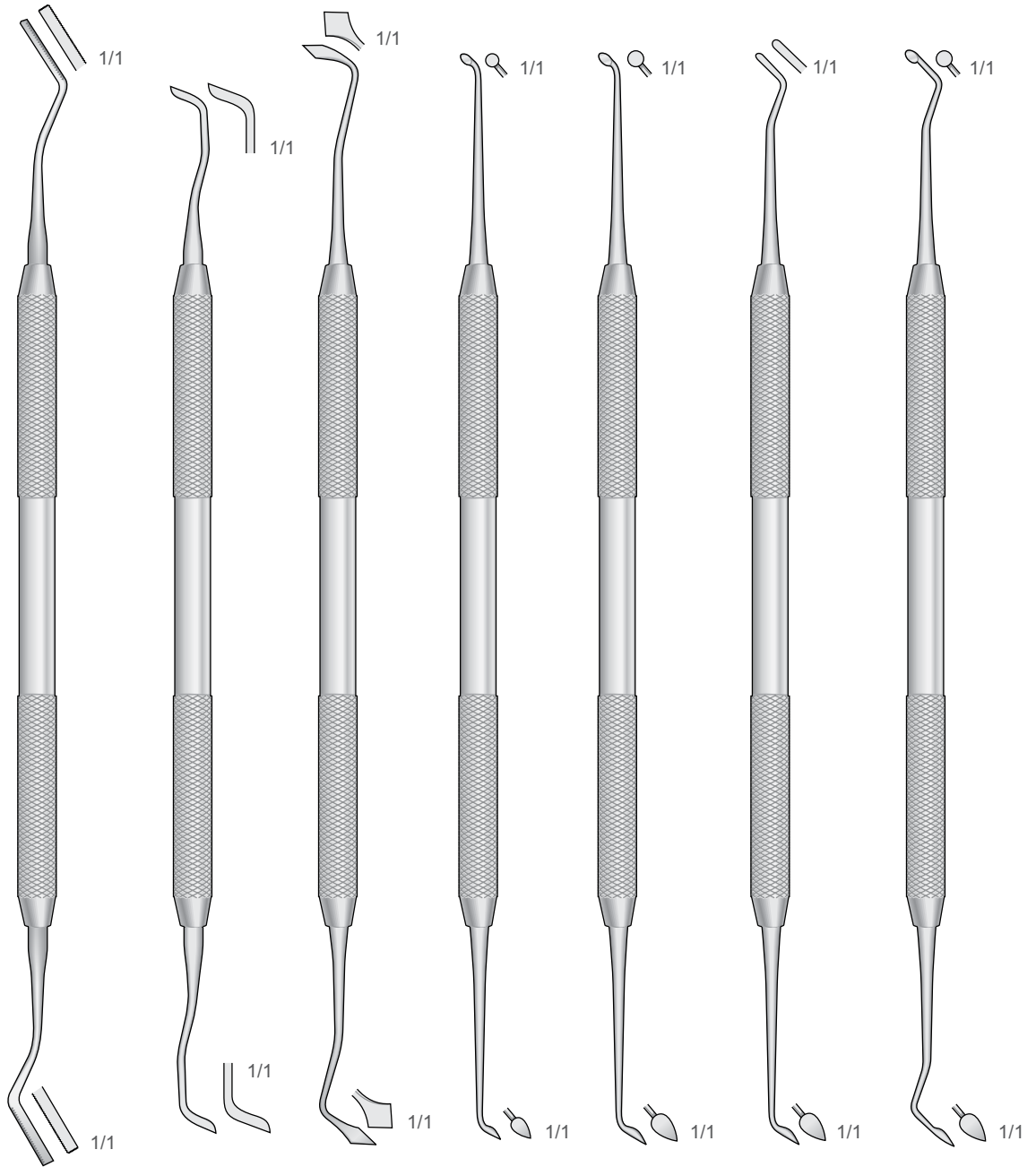
**R-3**  
HOLLENBACH  
# 3 - 165 mm

PERIOSTEALS  
 CURETTES &  
 BONE



Instrument für Drahrückzug  
 Instrument for retractor wire  
 Strumento per filo retrattore  
 Instrumento para hilo separador  
 Instruments pour fil séparateur

Cleoids - Discoids



CV-11

USC-2  
USC

F-2/3  
FRAHM

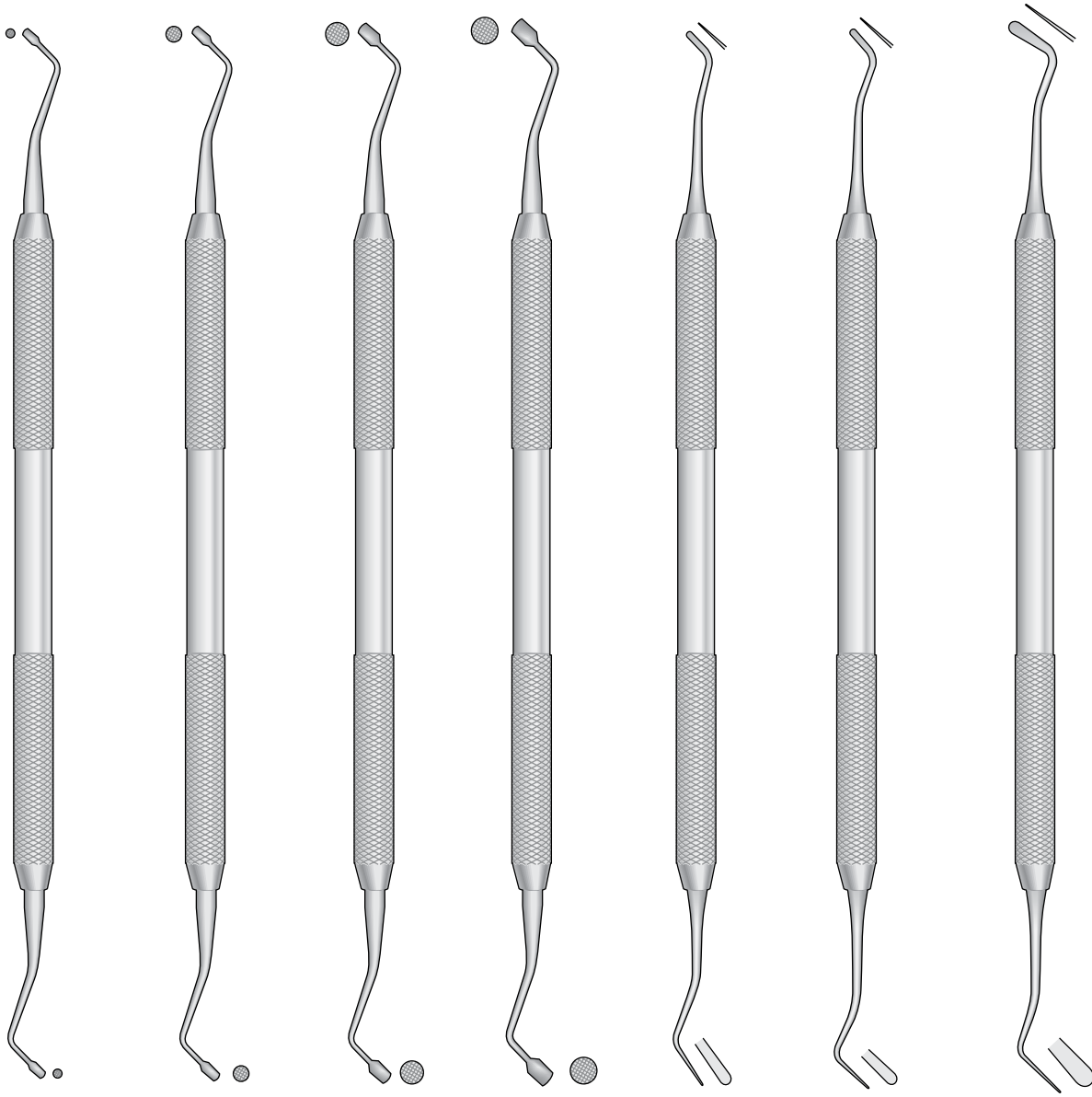
CD-1  
Fig. 1/2

CD-2  
Fig. 4/5

CD-3  
Fig. W.A.C.D.

CD-4  
Fig. 3/6

Füllungsinstrumente  
Filling Instruments  
Strumenti per otturazione  
Instrumentos para obturación  
Instruments pour obturation



O-1

O-2

O-3

O-4

OK-1

OK-2

OK-3

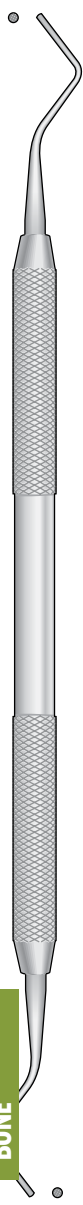
PERIOSTEALS  
CURETTES &  
BONE



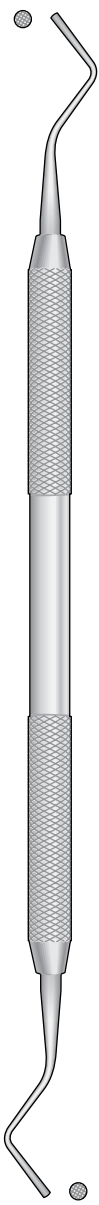
Gerieft  
 Serrated  
 Zigrinati  
 Estriados  
 Striée

Glatt  
 Smooth  
 Lisci  
 Lisos  
 Lissée

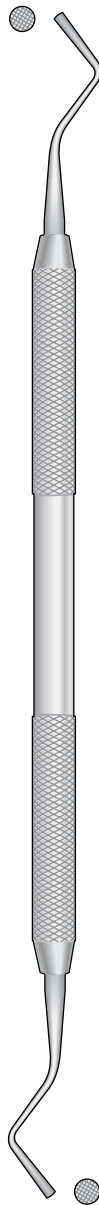
PERIOSTEALS  
 CURETTES &  
 BONE



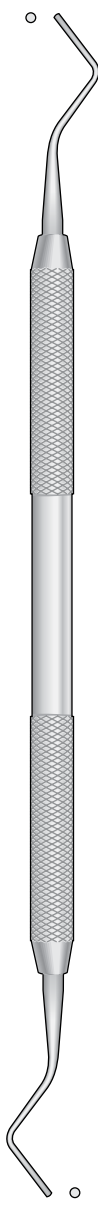
OZ-1  
 Fig.1



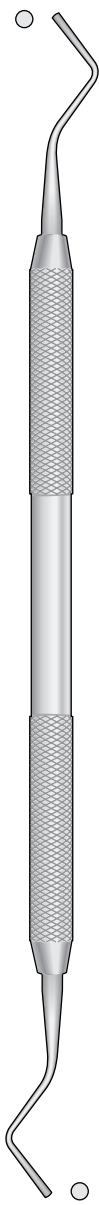
OZ-2  
 Fig.2



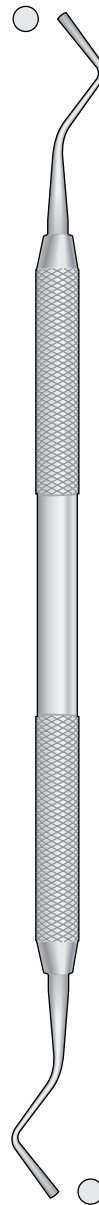
OZ-3  
 Fig.3



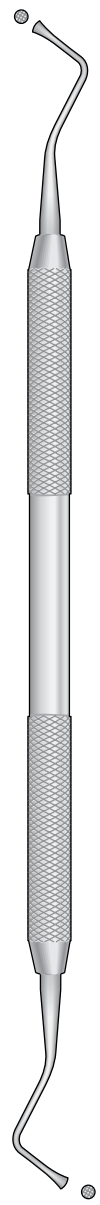
OL-1  
 Fig.1L



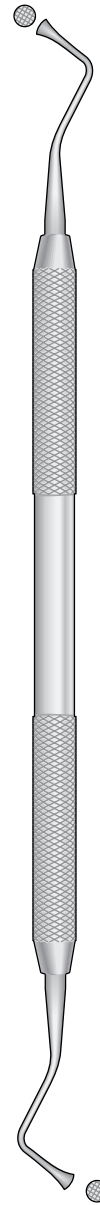
OL-2  
 Fig.2L



OL-3  
 Fig.3L



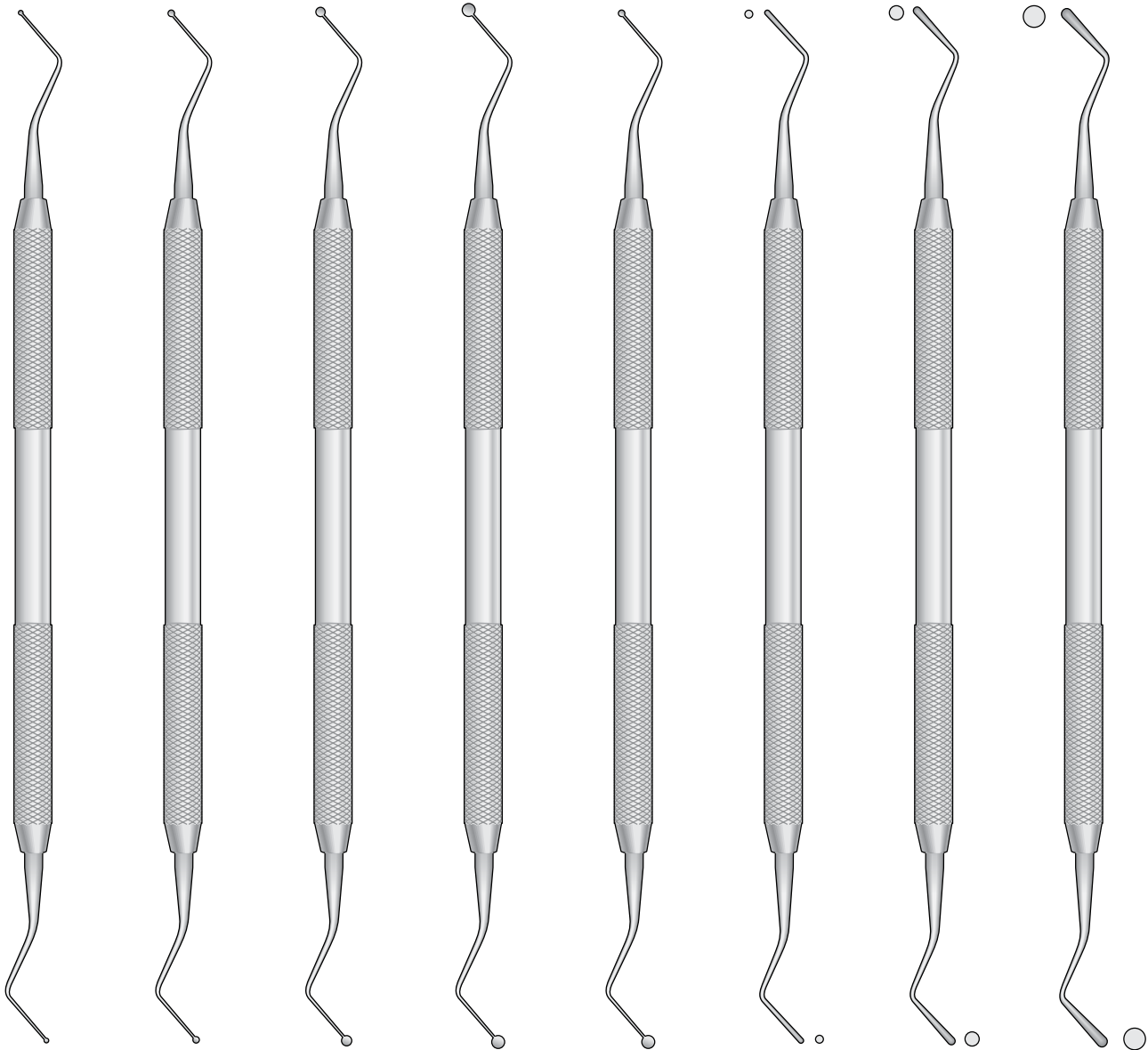
WARD  
 OC-1



WARD  
 OC-2



Füllungsinstrumente  
Filling Instruments  
Strumenti per otturazione  
Instrumentos para obturación  
Instruments pour obturation



**OP-1**  
Fig.1

**OP-2**  
Fig.2

**OP-3**  
Fig.3

**OP-4**  
Fig.4

**OP-5**  
Fig.5

**OA-1**  
Fig.1

**OA-2**  
Fig.2

**OA-3**  
Fig.3

PERIOSTEALS  
CURETTES &  
BONE



PERIOSTEALS  
CURETTES &  
BONE



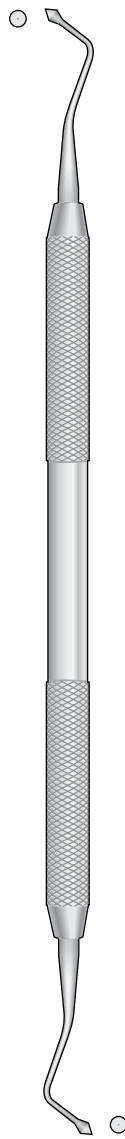
OX-1



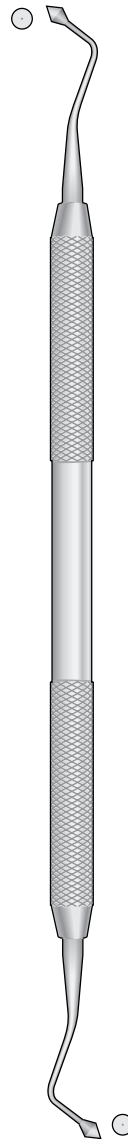
OX-2



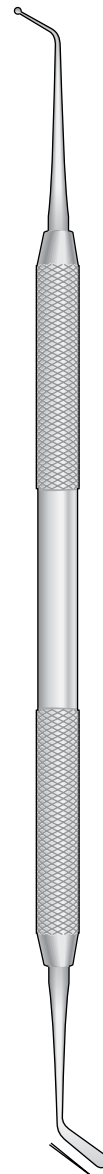
OX-3



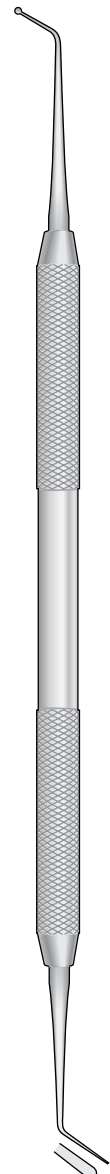
WESTCOTT  
OS-1



WESTCOTT  
OS-2



OM-2



ON-1

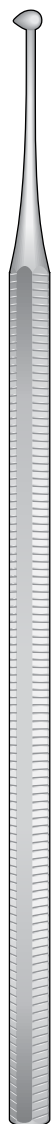




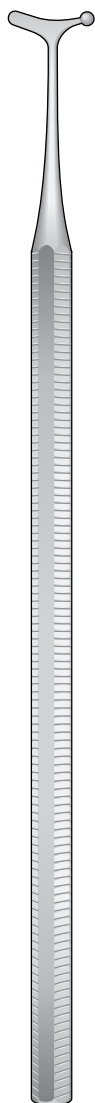
Füllungsinstrumente  
Filling Instruments  
Strumenti per otturazione  
Instrumentos para obturación  
Instruments pour obturation



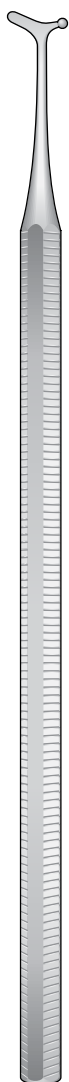
WHITE  
**B-3**  
n°28



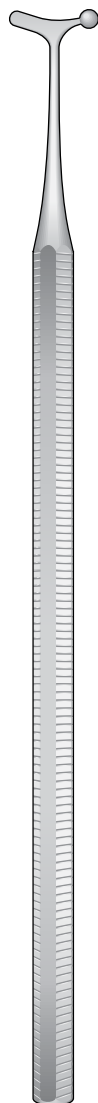
WHITE  
**B-4**  
n°29



WHITE  
**B-32**  
n°32



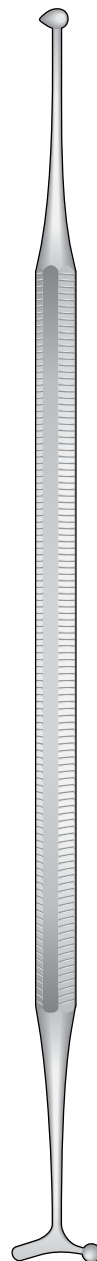
WHITE  
**B-33**  
n°33



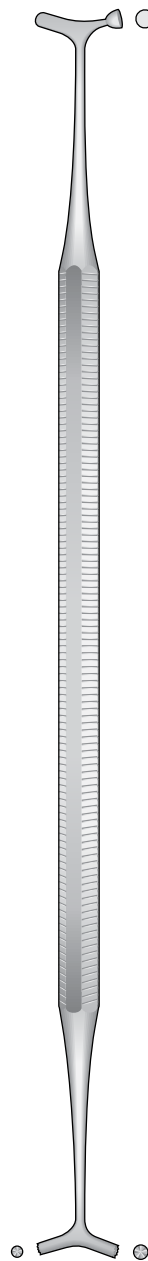
WHITE  
**B-34**  
n°34



WHITE  
**B-28/29**  
Doppio



WHITE  
**B-31/32**  
Doppio



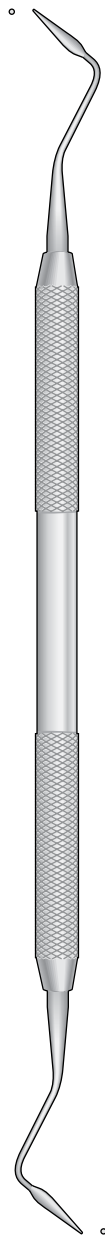
BENNET  
**B-35**  
170 mm

PERIOSTEALS  
CURETTES &  
BONE

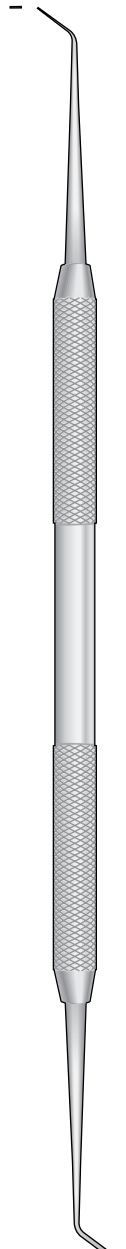
**MARKLEY PLUGGERS**  
Amalgam Instrumente  
Amalgam Instruments  
Strumenti per amalgama  
Instrumentos para amalgama  
Instruments à amalgame



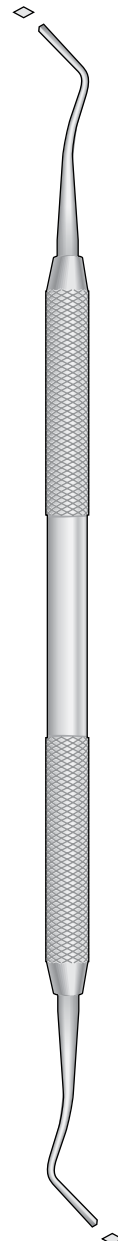
**PM-1**  
Fig.1M



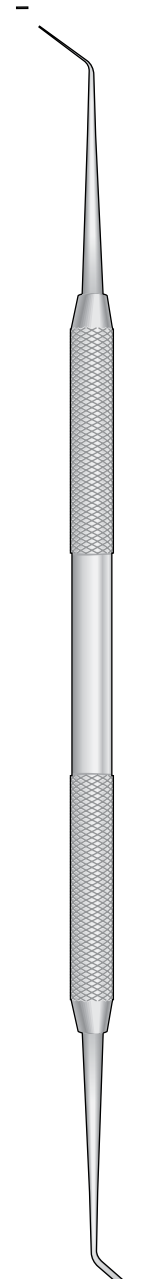
**PM-2**  
Fig.2M



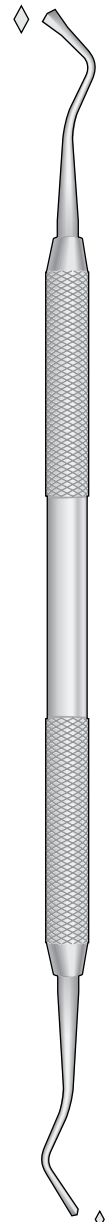
**PM-3**  
Fig.3M



**PM-4**  
Fig.4M



**PM-5**  
Fig.5M

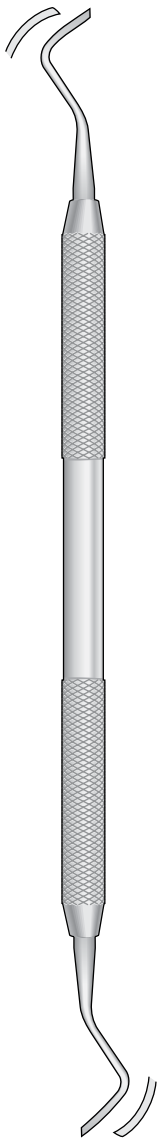


**PM-6**  
Fig.6M

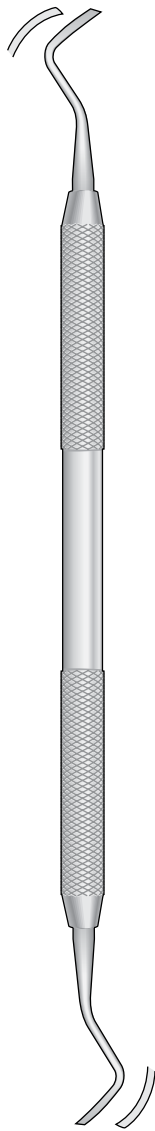
PERIOSTEALS  
CURETTES &  
BONE



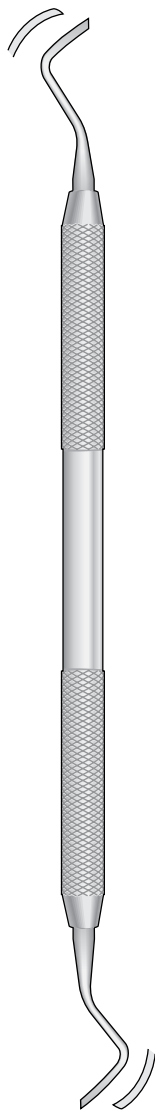
Schmelzinstrumente  
Enamel Instruments  
Strumenti da smalto  
Instrumentos para esmalte  
Instruments à émail



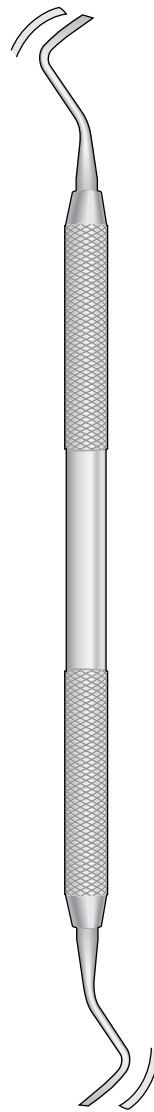
BLACK  
**TS-1**  
Fig.26



BLACK  
**TS-2**  
Fig.27



BLACK  
**TS-3**  
Fig.28

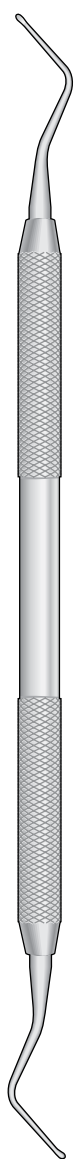


BLACK  
**TS-4**  
Fig.29

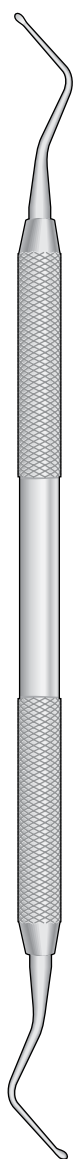
PERIOSTEALS  
CURETTES &  
BONE



PERIOSTEALS  
CURETTES &  
BONE



E-0  
Fig.0



E-1  
Fig.1



E-2  
Fig.2



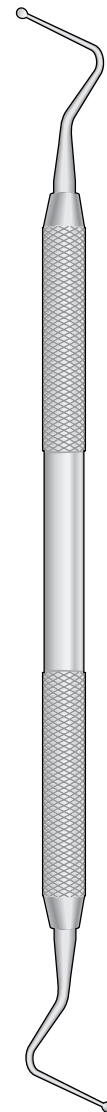
E-3  
Fig.3



E-4  
Fig.4



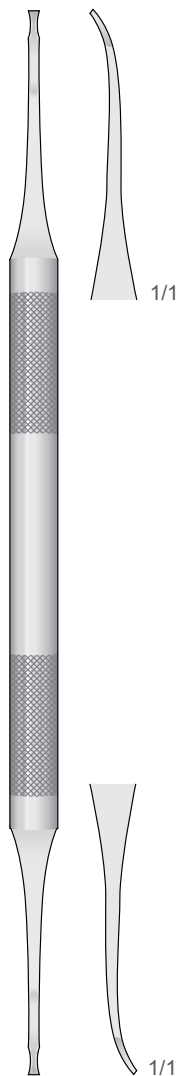
EC-1  
Fig.1



EC-2  
Fig.2

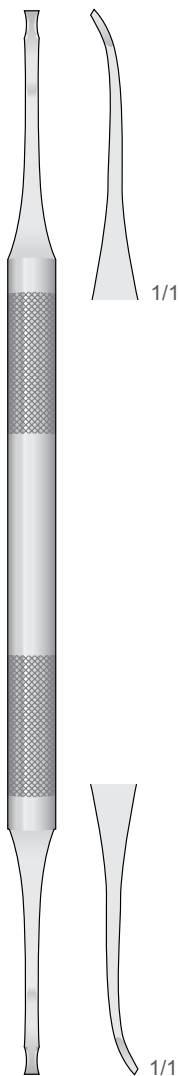
Meißel für Parodontologie  
 Periodontal Chisels  
 Scalpelli parodontali  
 Cinceles periodontales  
 Burins parodontaux

Fig. 1



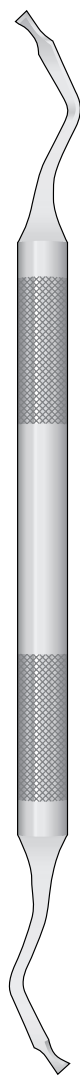
FEDI  
**OF-1**  
 175 mm

Fig. 2



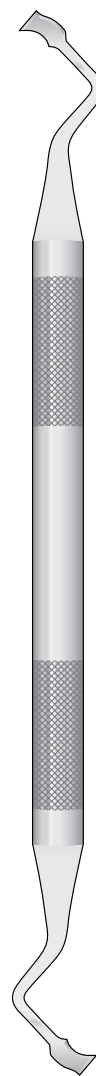
FEDI  
**OF-2**  
 175 mm

Fig. 3



FEDI  
**OF-3**  
 170 mm

Fig. 4



OCHSENBEIN  
**OSB-4A**  
 170 mm



OCHSENBEIN  
**OSB-4**  
 170 mm

PERIOSTEALS  
 CURETTES &  
 BONE



Bevel IN  
 Fig.1



OCHSENBEIN-1  
**OSB-1**  
 165 mm

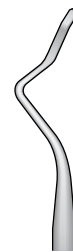
Bevel OUT  
 Fig.2



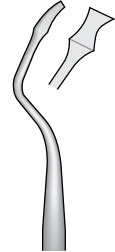
OCHSENBEIN-2  
**OSB-2**  
 165 mm



TG CHISELS  
**718-113**



OCHSENBEIN-3  
**718-103**



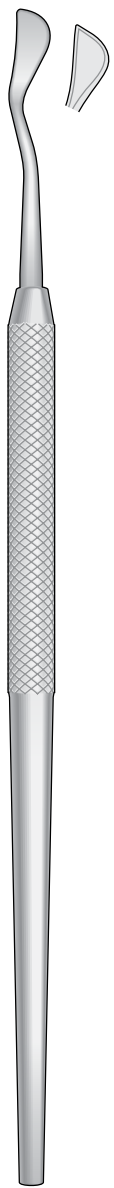
OCHSENBEIN-4  
**718-104**



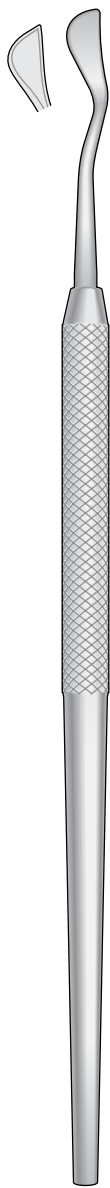
RHODES BACK ACTION  
**718-107**



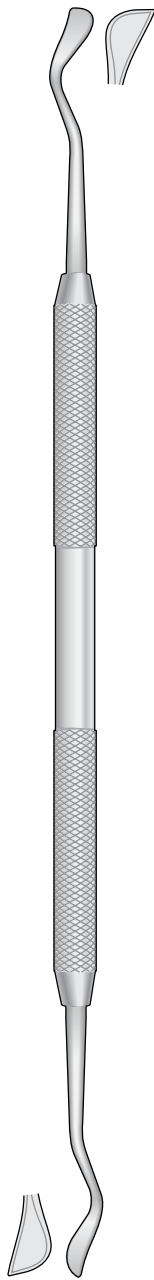
Parodontalmesser  
 Gengivectomy Knives  
 Bisturi per gengivectomia  
 Bisturías para la gengivectomía  
 Bistouris pour la gengivectomie



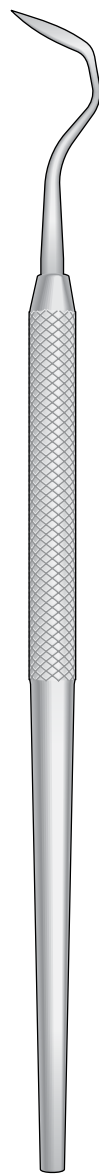
KIRKLAND  
**KKD-1**  
 Fig.15K



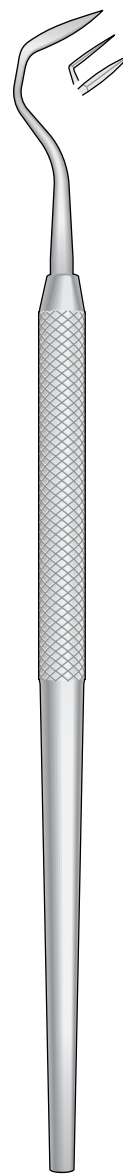
KIRKLAND  
**KKD-2**  
 Fig.16K



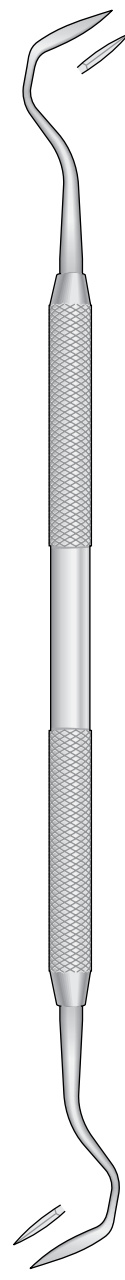
KIRKLAND  
**KKD-4**  
 Fig.15K - Fig.16K



ORBAN  
**OBN-1**  
 Fig.1



ORBAN  
**OBN-2**  
 Fig.2

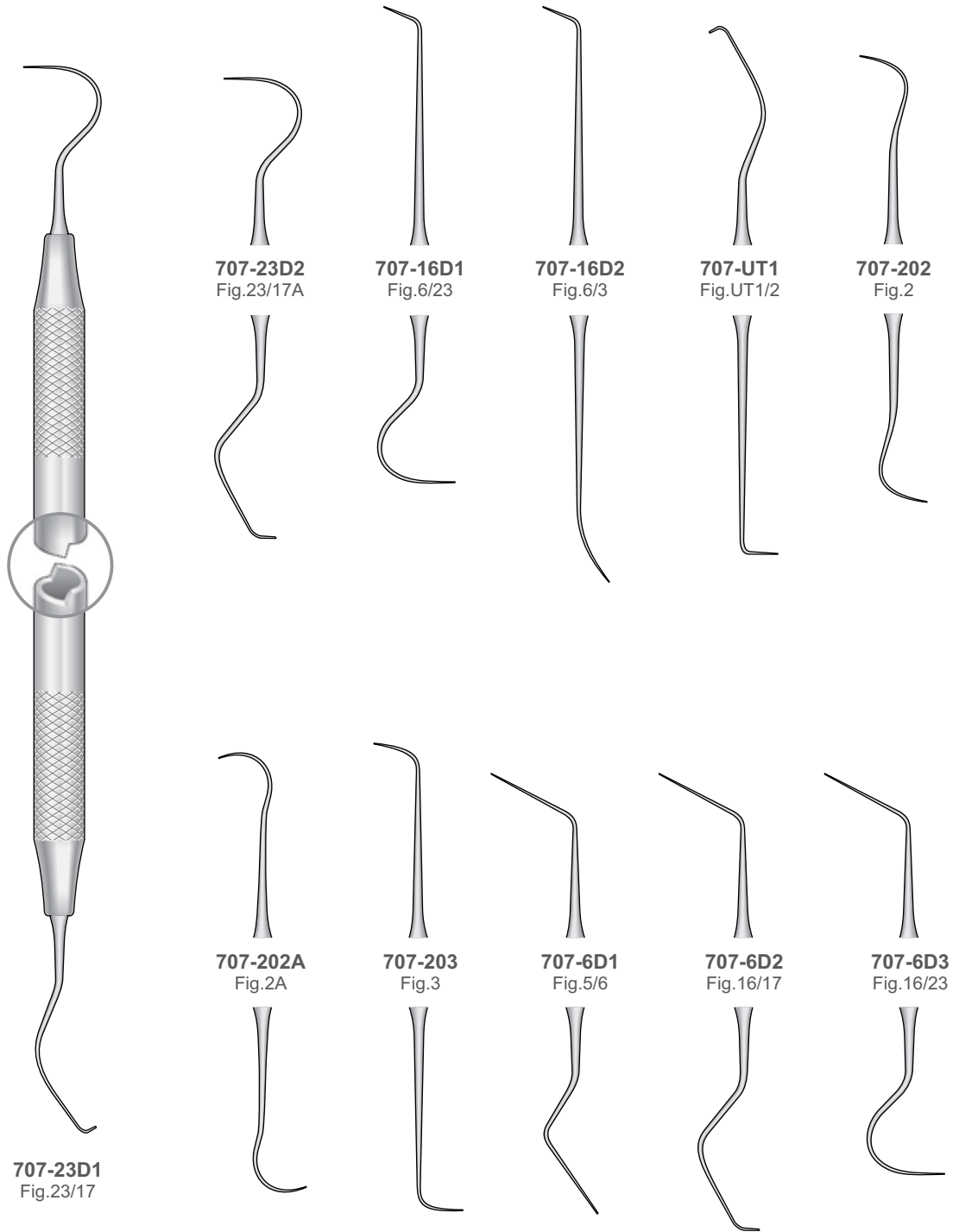


ORBAN  
**OBN-4**  
 Fig.1 - Fig.2

PERIOSTEALS  
 CURETTES &  
 BONE



Doppelendiger Zahnsonden  
 Double-ended Explorer  
 Sonda falce doppia  
 Sonda exploradora doble  
 Sonde exploratrice double



**707-23D2**  
Fig.23/17A

**707-16D1**  
Fig.6/23

**707-16D2**  
Fig.6/3

**707-UT1**  
Fig.UT1/2

**707-202**  
Fig.2

**707-202A**  
Fig.2A

**707-203**  
Fig.3

**707-6D1**  
Fig.5/6

**707-6D2**  
Fig.16/17

**707-6D3**  
Fig.16/23

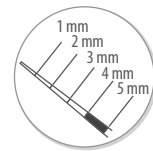
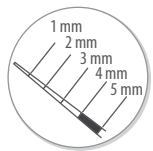
**707-23D1**  
Fig.23/17

PERIOSTEALS  
 CURETTES &  
 BONE



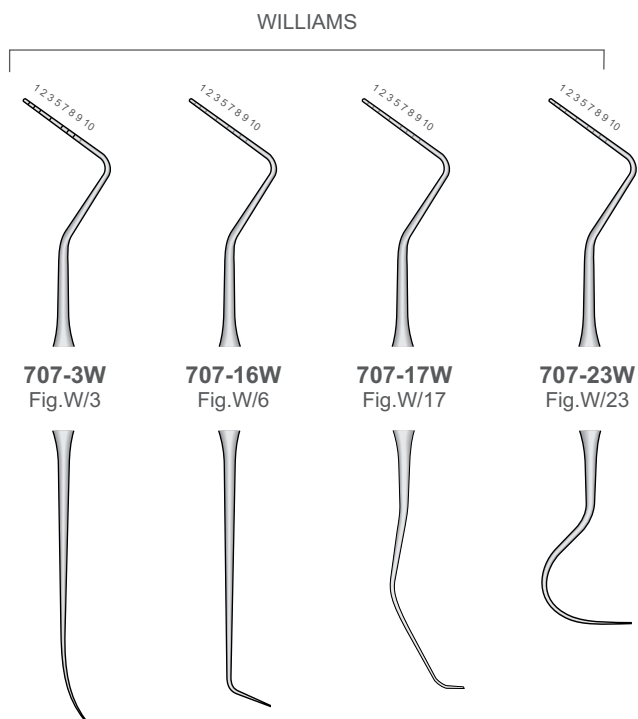
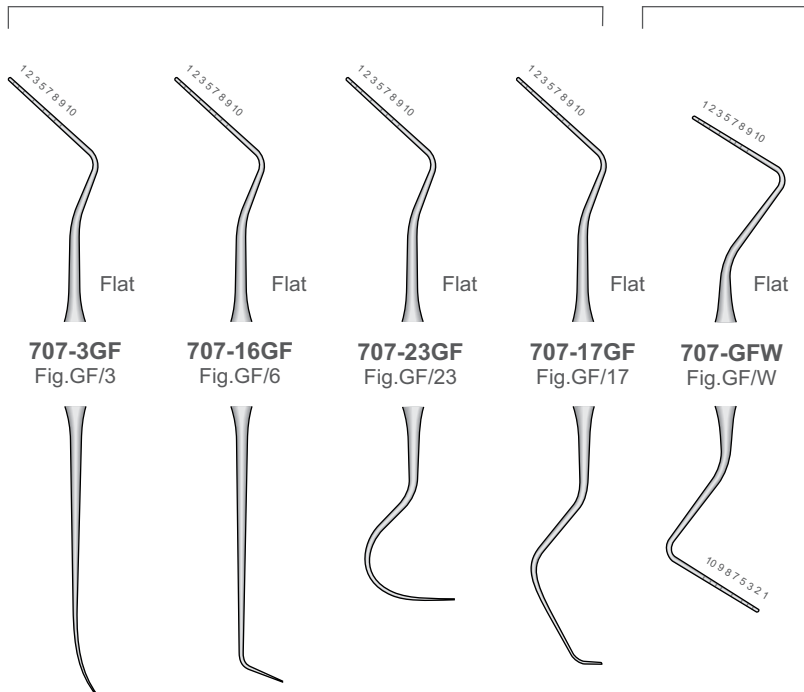
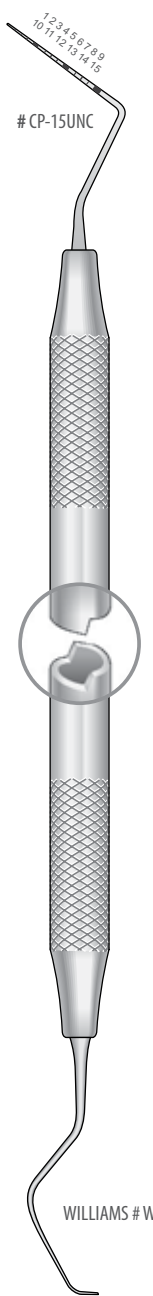


Doppelendiger Parodontometer  
 Double-ended Periodontal Probes  
 Sondes parodontales doubles  
 Sonde parodontali doppie  
 Sondas parodontales doubles



GOLDMANN-FOX

GOLDMANN-FOX WILLIAMS



**707-1715**  
 # CP-15UNC-17A  
 170 mm

**707-2315**  
 # CP-15UNC-23/W  
 170 mm

PERIOSTEALS  
 CURETTES &  
 BONE



Doppelendiger Parodontometer  
 Double-ended Periodontal Probes  
 Sondes parodontales doubles  
 Sonde parodontali doppie  
 Sondas parodontales doubles

UNIVERSITY OF MICHIGAN



Ø 8 mm  
**Hollow**  
 Hohl  
 Creux  
 Hueco  
 Vuoto

**707-3UM**  
 Fig.UM/3



**707-16UM**  
 Fig.UM/6



**707-23UM**  
 Fig.UM/23



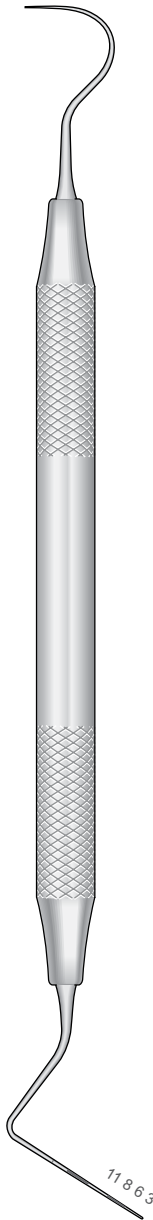
**707-17UMF**  
 Fig.UM/17



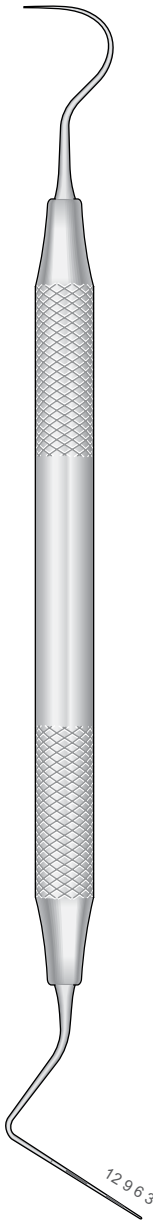
NABERS  
**707-1N**  
 Fig. 1N



NABERS  
**707-2N**  
 Fig. 2N



WILLIAMS  
**707-2311**  
 Fig.CP11/23



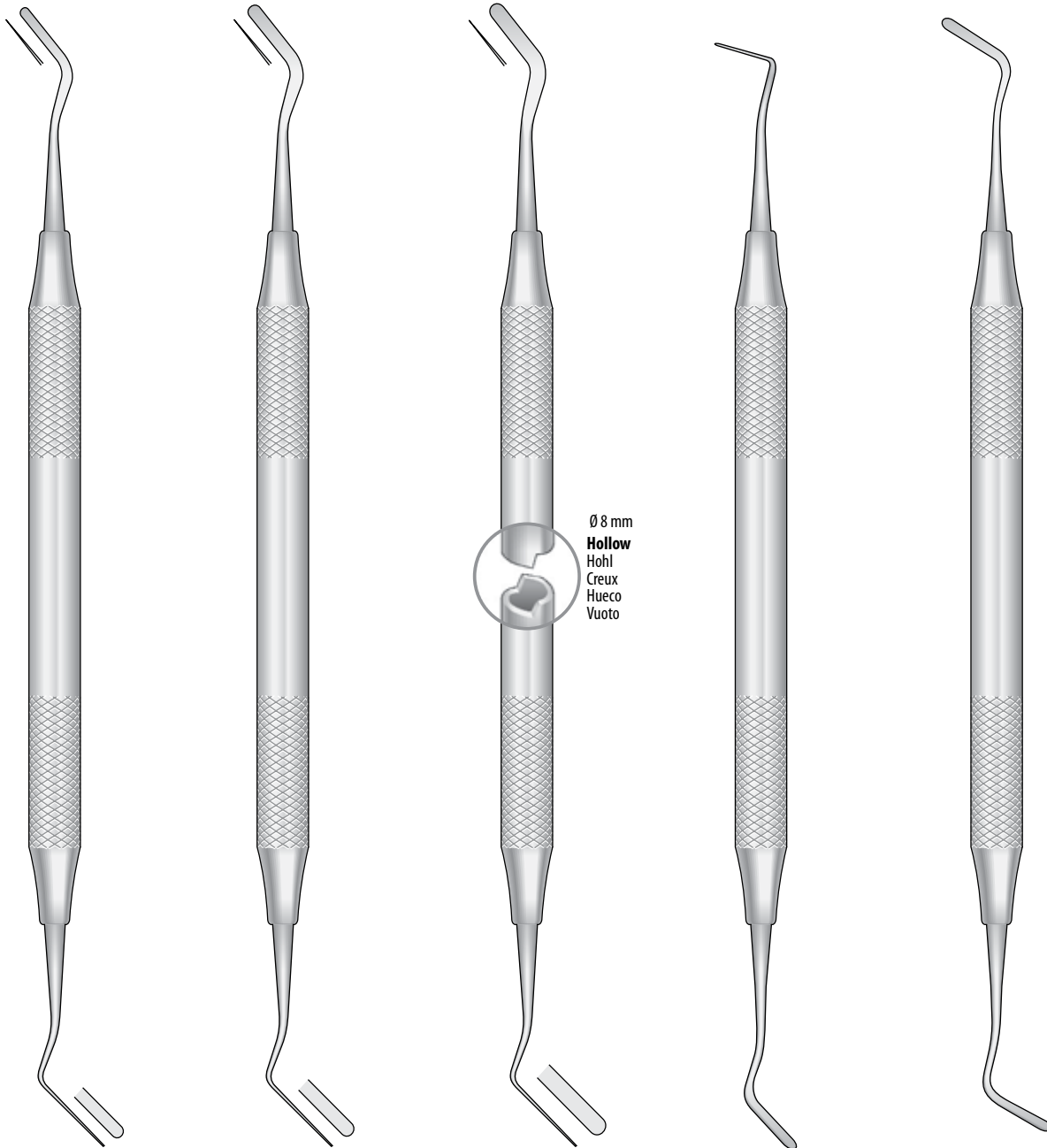
WILLIAMS  
**707-2312**  
 Fig.CP12/23

PERIOSTEALS  
 CURETTES &  
 BONE



Spateln - Füllungsinstrumente  
 Spatulas - Filling Instruments  
 Spatole - Strumenti per otturazione  
 Espátulas - Instrumentos para obturación  
 Spatules - Instruments pour obturation

Heidemann Spateln  
 Heidemann Spatulas  
 Spatole Heidemann  
 Espátulas Heidemann  
 Spatules Heidemann



HEIDEMANN  
 711-301  
 Fig.1

HEIDEMANN  
 711-302  
 Fig.2

HEIDEMANN  
 711-303  
 Fig.3

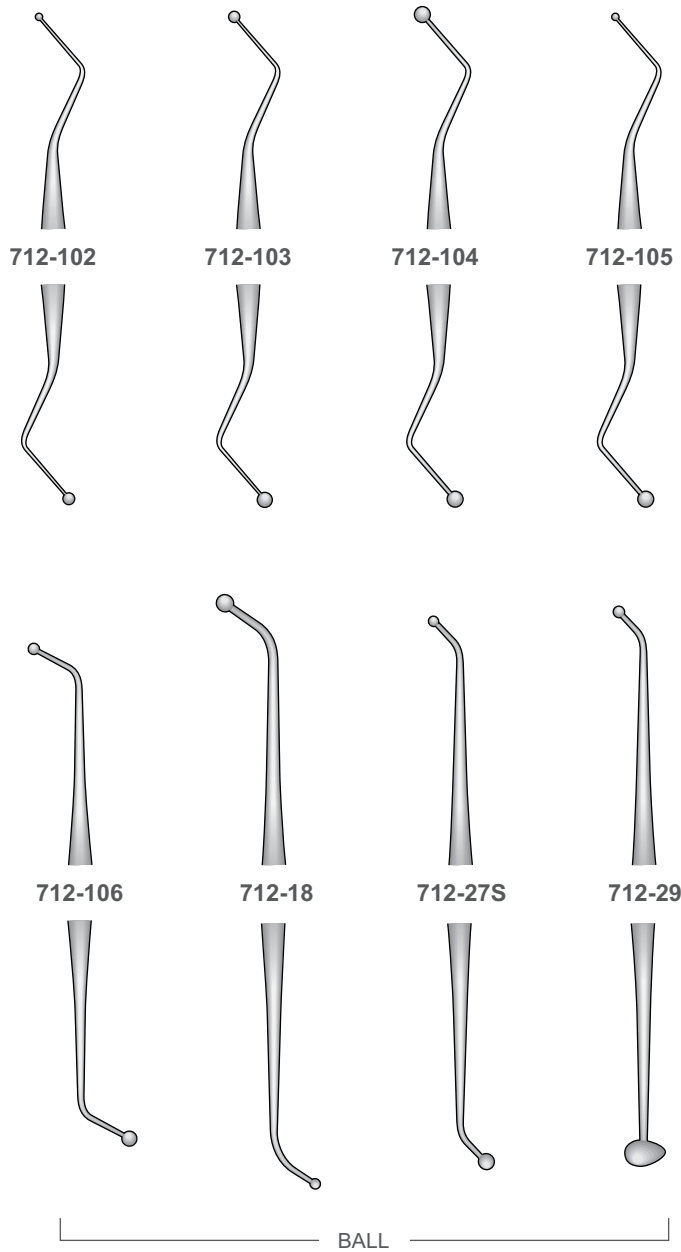
IPC Fig. 1  
 715-311  
 Interproximal

IPC/OA Fig. 2  
 715-312  
 Interproximal Off-Angle

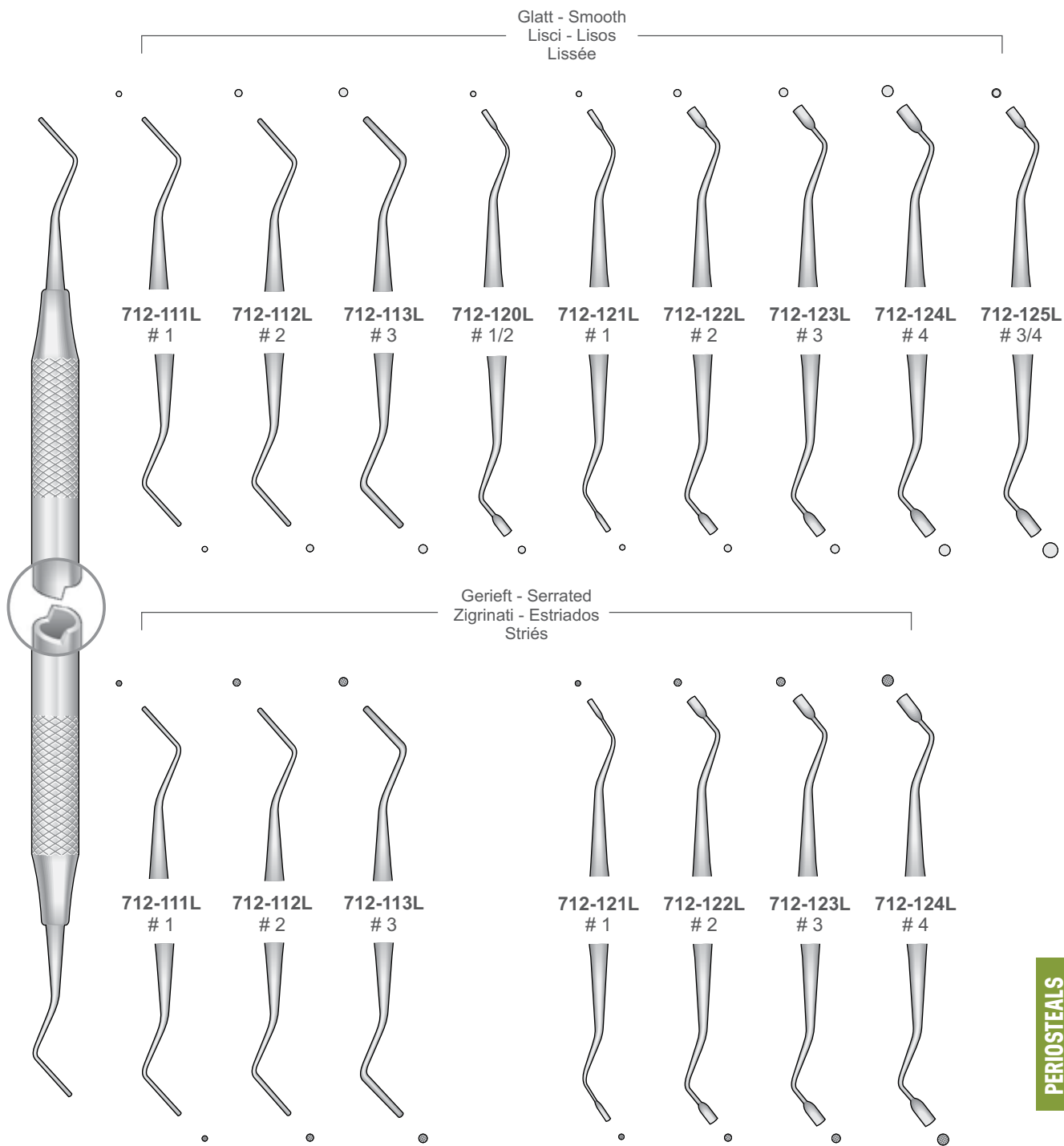
PERIOSTEALS  
 CURETTES &  
 BONE



Ø 8 mm  
 Hollow  
 Hohl  
 Creux  
 Hueco  
 Vuoto



712-101



PERIOSTEALS  
 CURETTES &  
 BONE



Ø 8 mm  
**Hollow**  
 Hohl  
 Creux  
 Hueco  
 Vuoto

712-PFI  
 170 mm

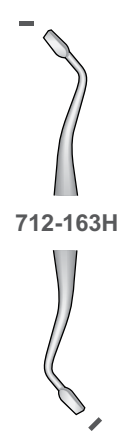
HOLLENBACK



712-161H



712-162H



712-163H



712-164H

MARKLEY PLUGGERS

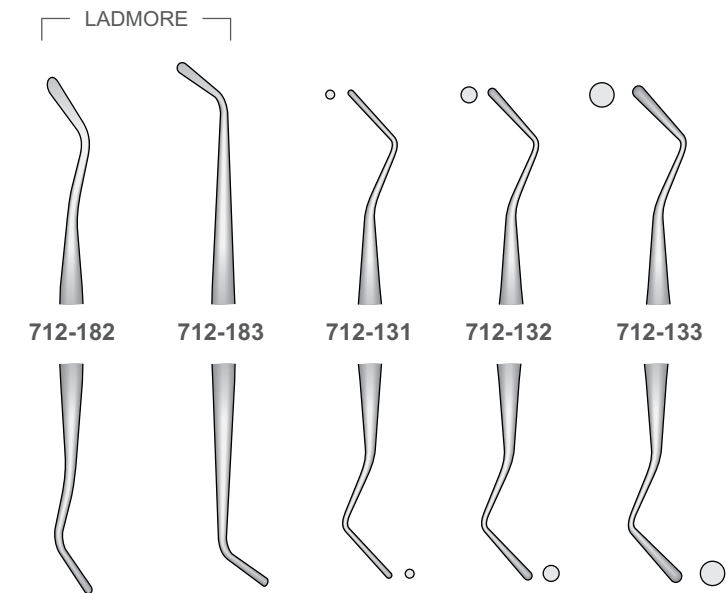
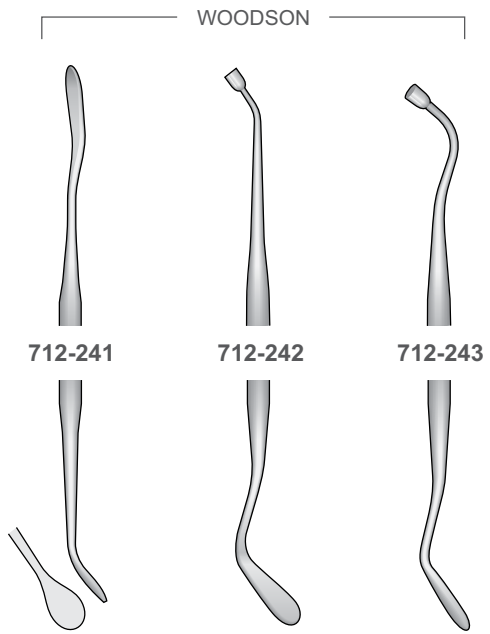
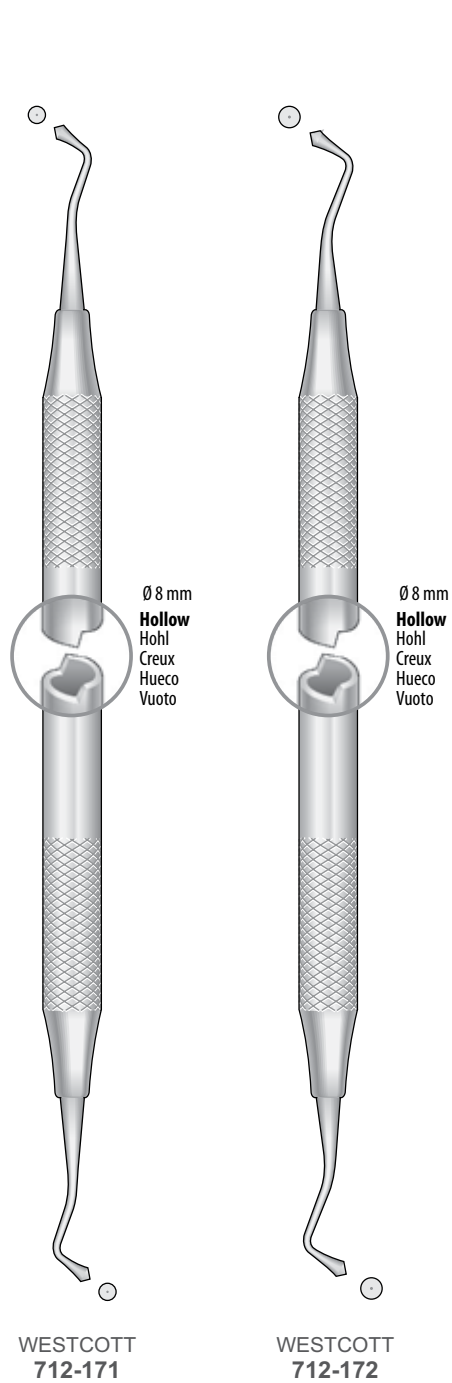


714-101

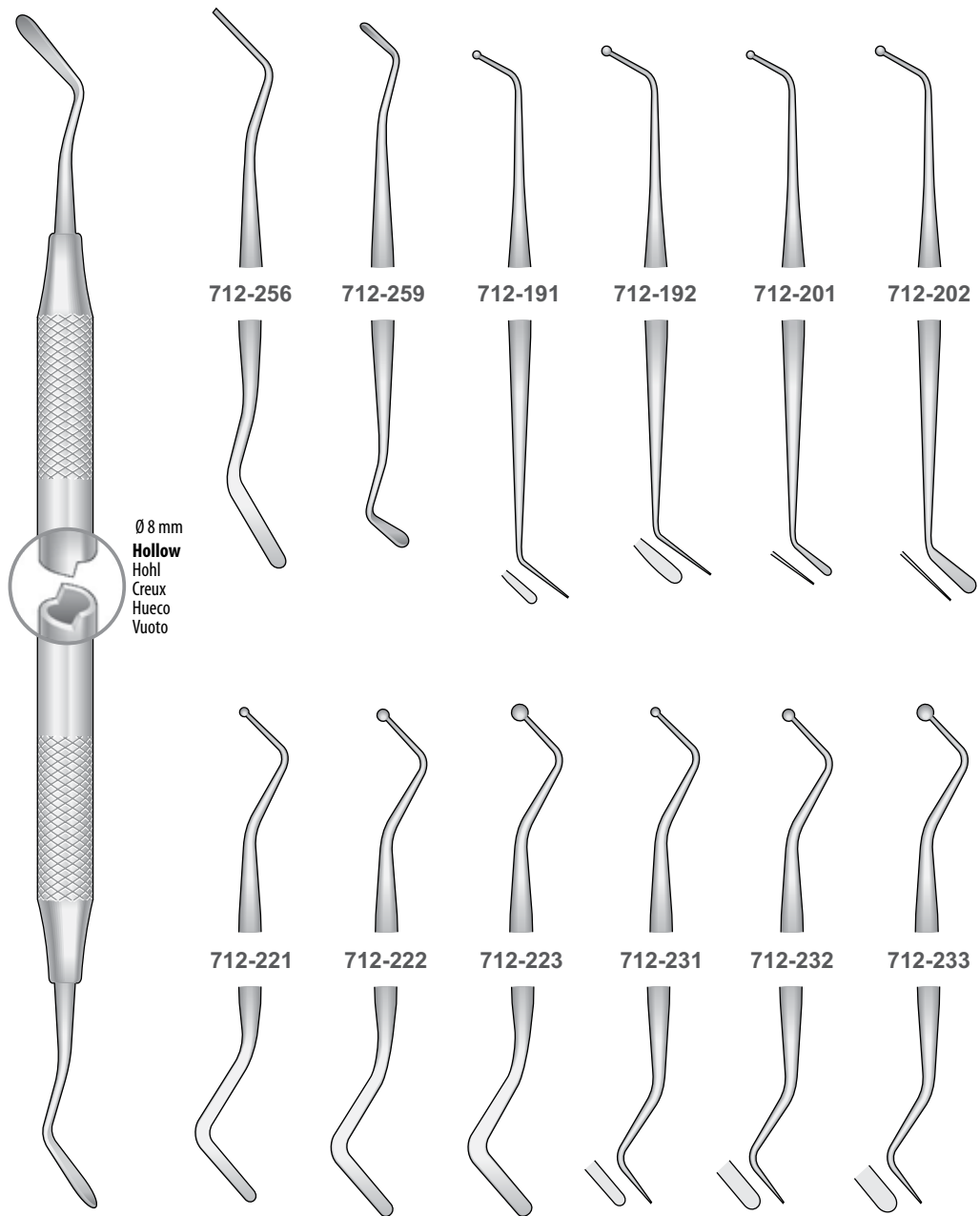


714-102

Füllungsinstrumente  
 Filling Instruments  
 Strumenti per otturazione  
 Instrumentos para obturación  
 Instruments pour obturation



PERIOSTEALS  
 CURETTES &  
 BONE



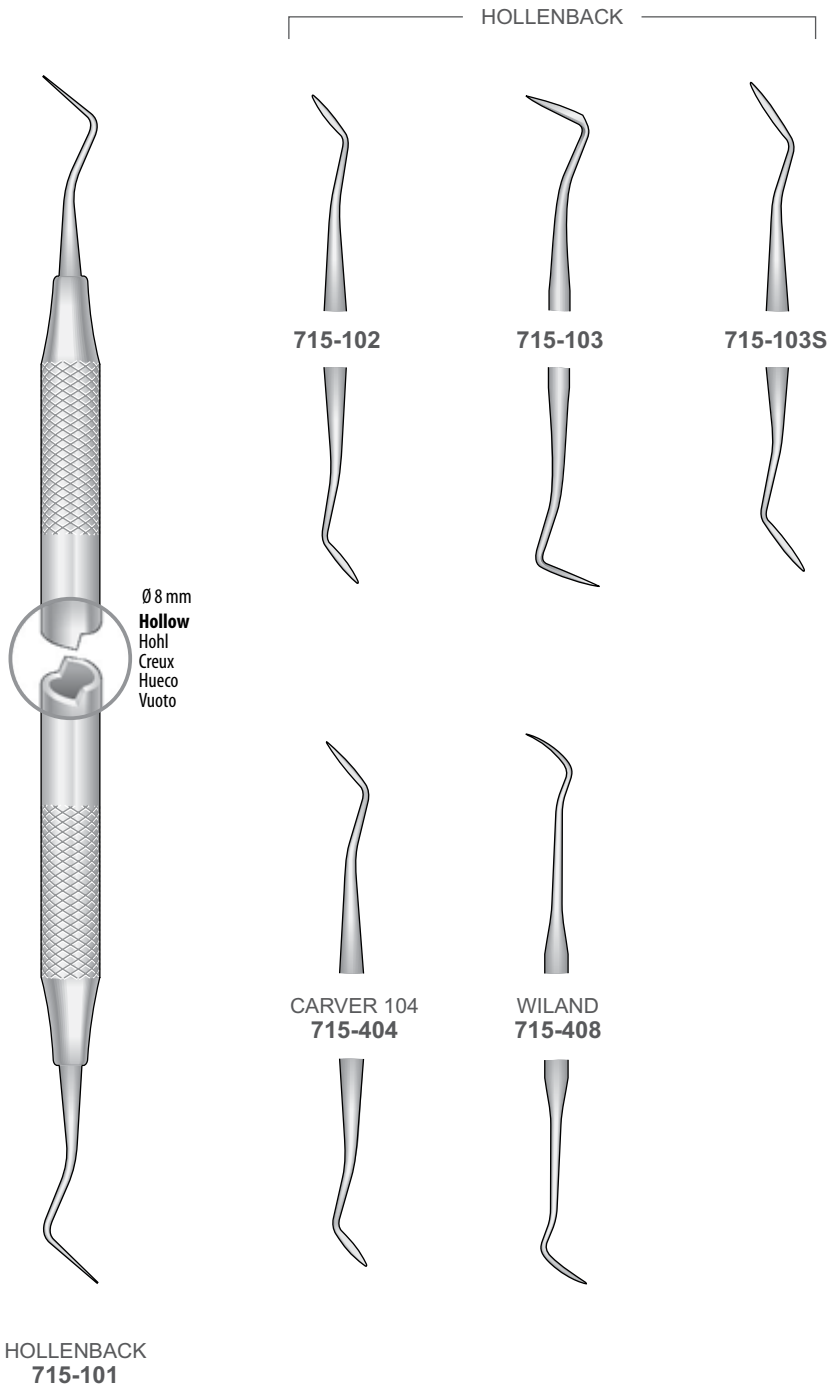
712-251

PERIOSTEALS  
 CURETTES &  
 BONE



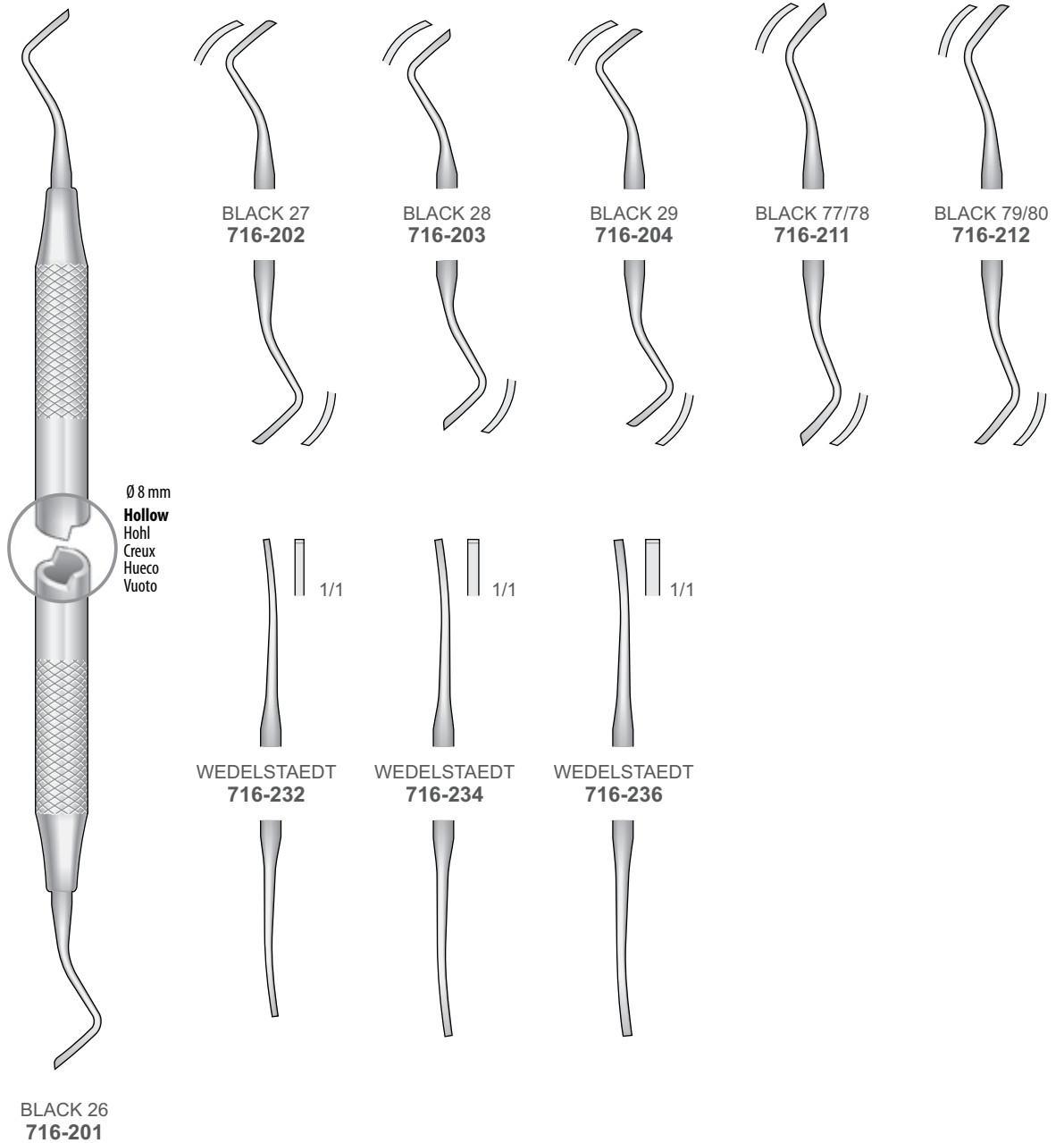


Amalgam Instrumente  
 Amalgam carvers  
 Strumenti per modellare otturazioni  
 Instrumentos para modelar las obturaciones  
 Instruments à modeler les obturations



PERIOSTEALS  
 CURETTES &  
 BONE





PERIOSTEALS  
 CURETTES &  
 BONE

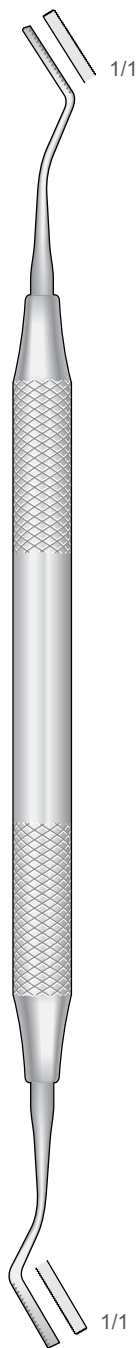


Amalgam Instrumente  
 Amalgam carvers  
 Strumenti per modellare otturazioni  
 Instrumentos para modelar las obturaciones  
 Instruments à modeler les obturations

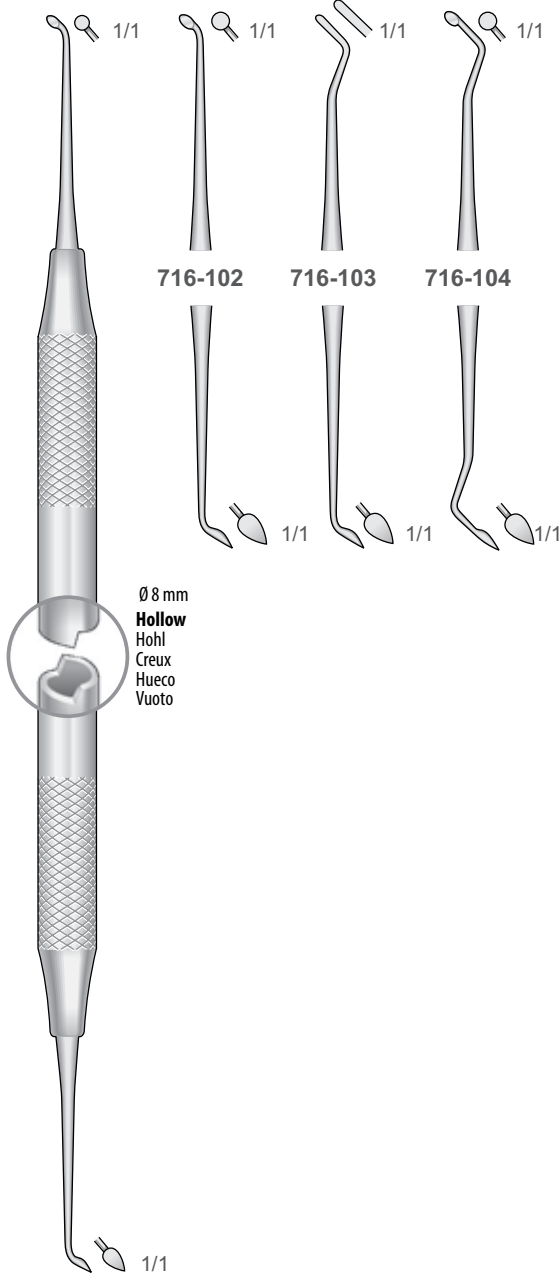
Instrument für Drahrückzug  
 Instrument for Retractor wire  
 Strumento per filo retrattore  
 Instrumento para hilo retractor  
 Instruments pour fil rtracteur

Cleoids - Discoids

Dykal Applikator  
 Placement Instruments  
 Applicatori per sottofondo  
 Aplicadores de fondo de cavidades  
 Applicateurs de fond de cavité



714-CV11

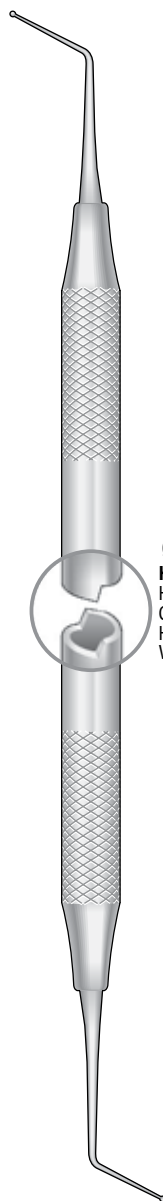


716-101

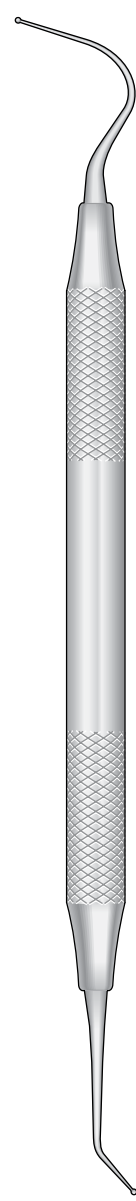
716-102

716-103

716-104



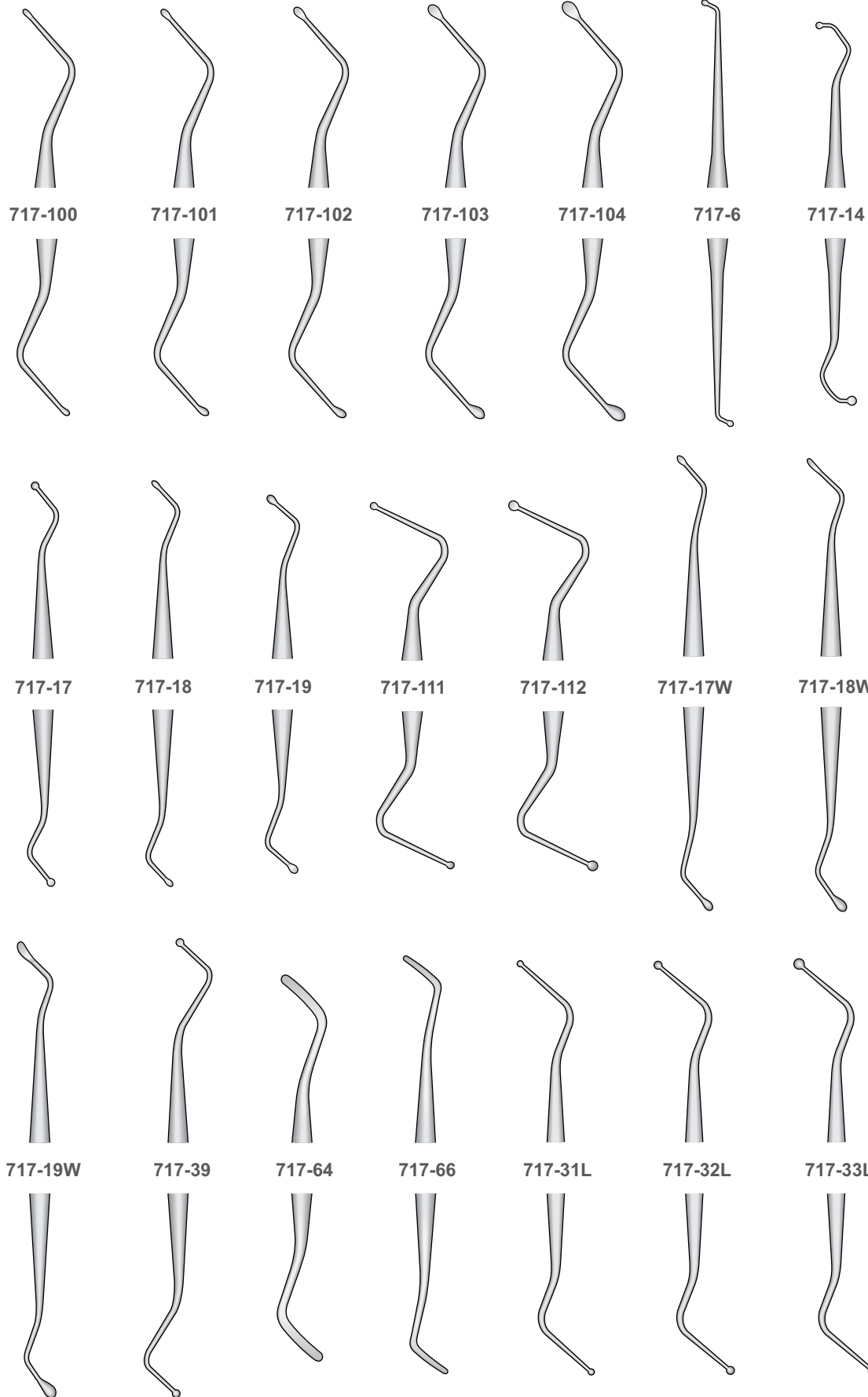
713-101



713-102

PERIOSTEALS  
 CURETTES &  
 BONE

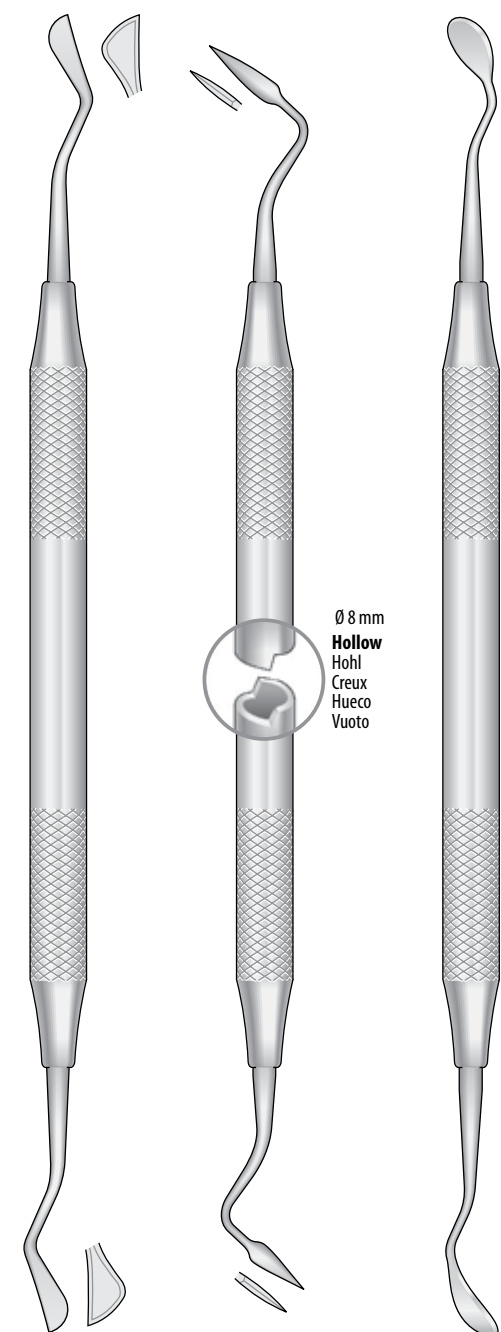
Excavatoren  
Excavators  
Excavatori  
Excavadores  
Excavateurs



PERIOSTEALS  
CURETTES &  
BONE



Parodontalmesser  
 Gingivectomy knives  
 Bisturi per gengivectomia  
 Bisturíes para la gingivectomía  
 Bistouris pour la gingivectomie

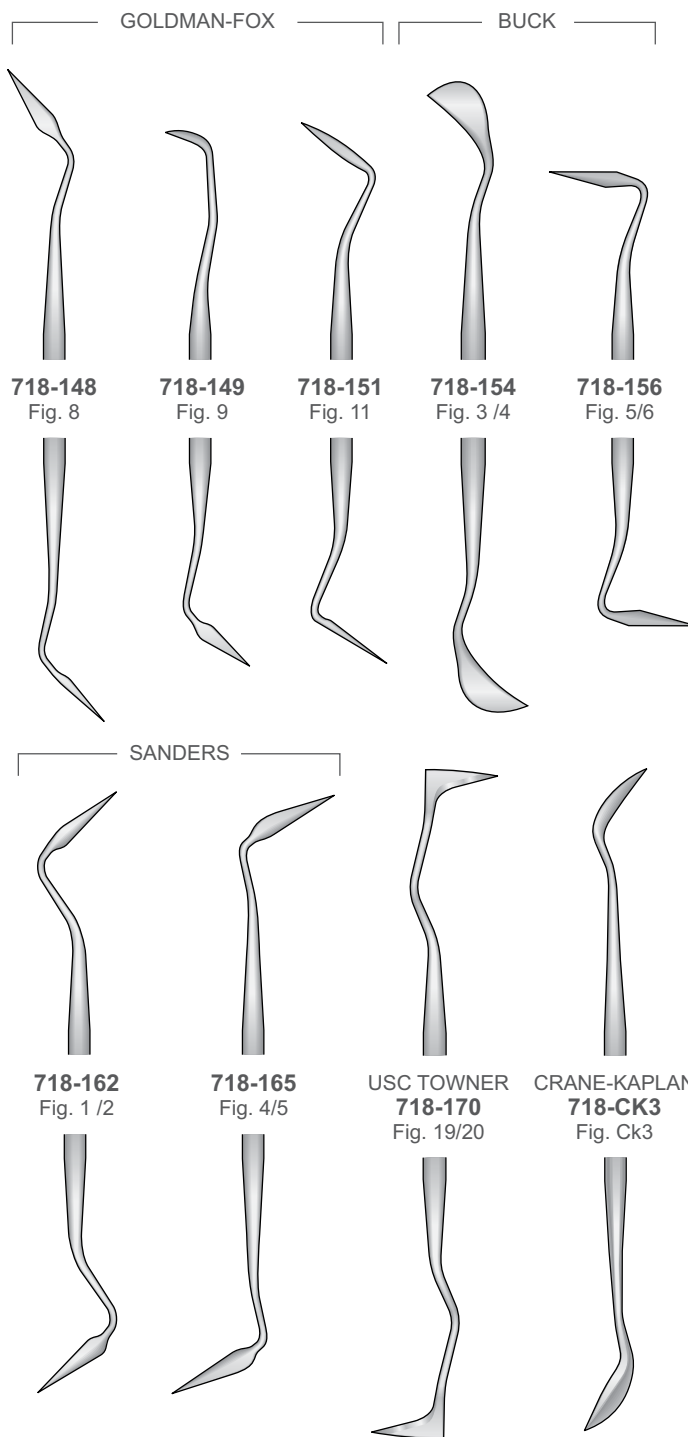


KIRKLAND  
**718-123**  
 Fig. 15K/16K

ORBAN  
**718-133**  
 Fig. 1 / 2

GOLDMAN-FOX  
**718-147**  
 Fig. 7

Ø 8 mm  
**Hollow**  
 Hohl  
 Creux  
 Hueco  
 Vuoto



**718-148**  
 Fig. 8

**718-149**  
 Fig. 9

**718-151**  
 Fig. 11

**718-154**  
 Fig. 3 / 4

**718-156**  
 Fig. 5/6

**718-162**  
 Fig. 1 / 2

**718-165**  
 Fig. 4/5

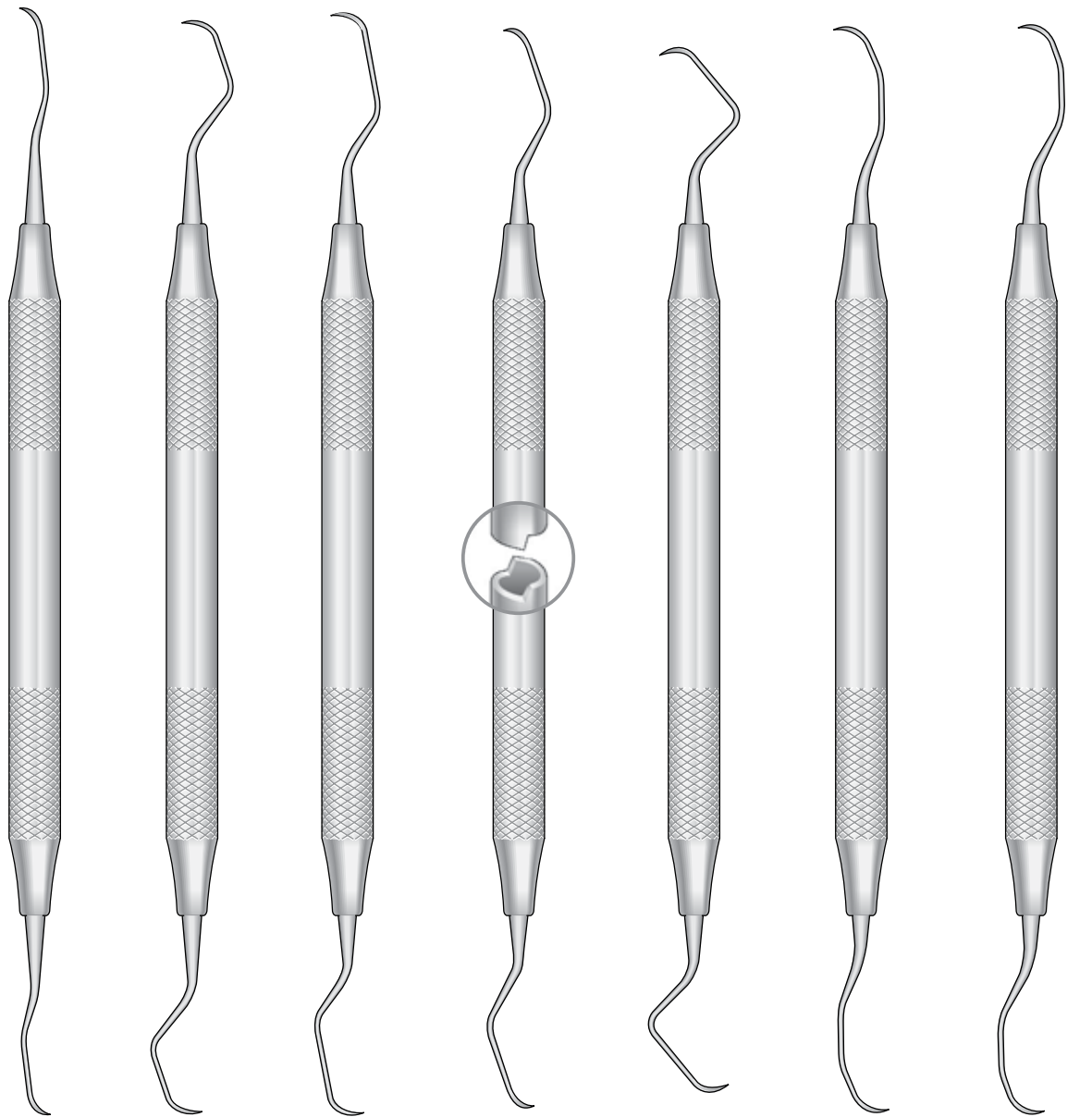
USC TOWNER  
**718-170**  
 Fig. 19/20

CRANE-KAPLAN  
**718-CK3**  
 Fig. Ck3

PERIOSTEALS  
 CURETTES &  
 BONE



GRACEY



GRACEY  
718-1/2

GRACEY  
718-3/4

GRACEY  
718-5/6

GRACEY  
718-7/8

GRACEY  
718-9/10

GRACEY  
718-11/12

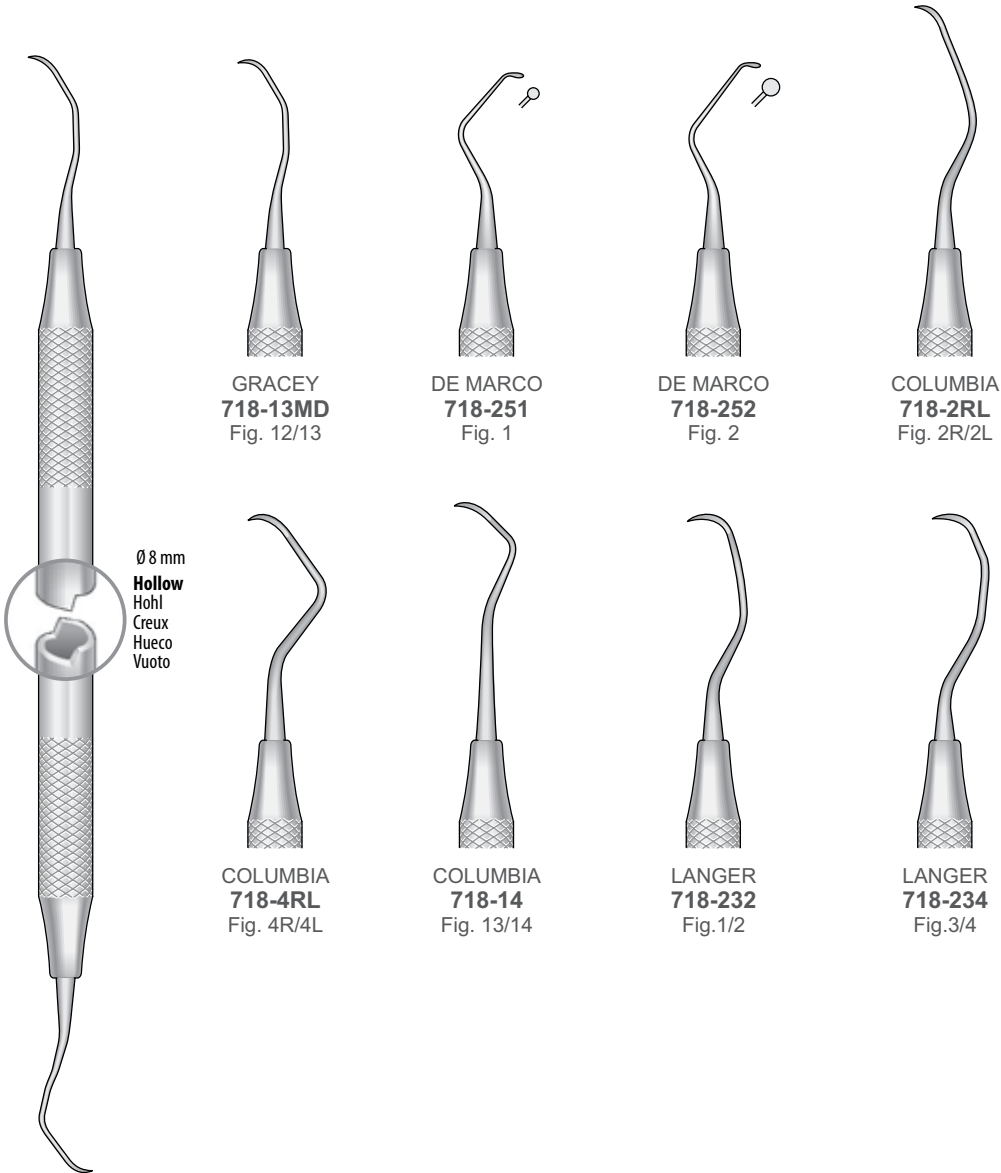
GRACEY  
718-13/14

PERIOSTEALS  
CURETTES &  
BONE



Küretten  
Curettes  
Curette  
Curetas  
Curettes

Mesial - Distal

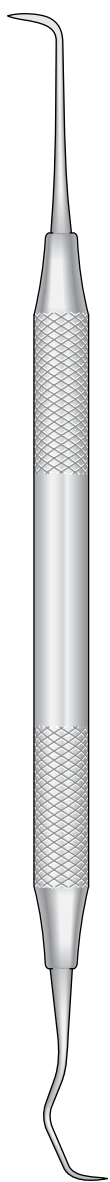


GRACEY  
**718-11MD**  
Fig. 11/14

PERIOSTEALS  
CURETTES &  
BONE



PERIOSTEALS  
CURETTES &  
BONE



GOLDMAN-FOX  
**718-271**  
Fig. 1



GOLDMAN-FOX  
**718-272**  
Fig. 2



GOLDMAN-FOX  
**718-273**  
Fig. 3



GOLDMAN-FOX  
**718-274**  
Fig. 4



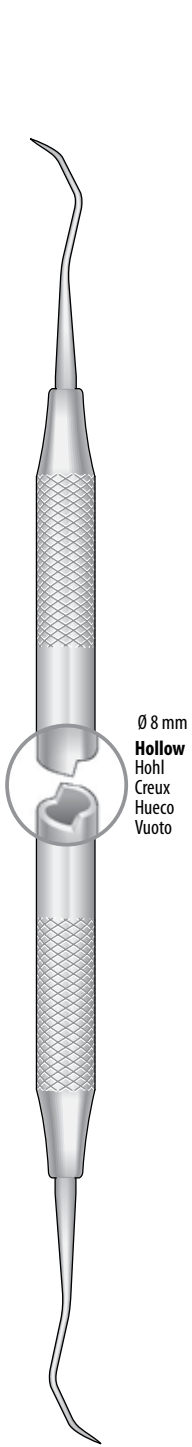
GOLDMAN-FOX  
**718-275**  
Fig. 5



GOLDMAN-FOX  
**718-277**  
Fig. 21

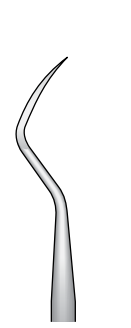




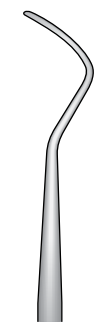
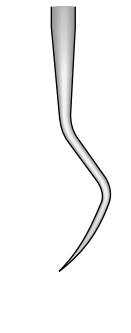


Ø 8 mm  
**Hollow**  
 Hohl  
 Creux  
 Hueco  
 Vuoto

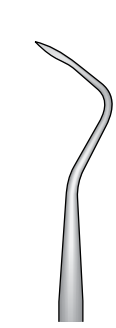
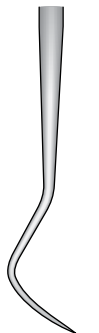
MC CALL  
**718-282**  
 Fig. 11/12



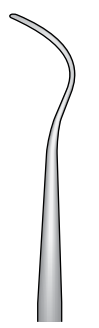
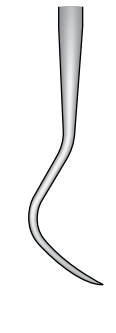
MC CALL  
**718-282A**  
 Fig. 11A/12A



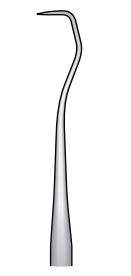
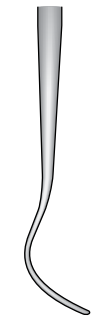
MC CALL  
**718-284**  
 Fig. 13/14



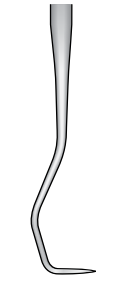
MC CALL  
**718-284S**  
 Fig. 13S/14S



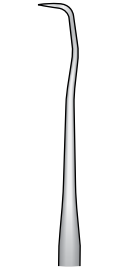
MC CALL  
**718-288S**  
 Fig. 17S/18S



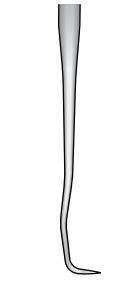
JAQUETTE  
**718-333**  
 Fig. 30/33



JAQUETTE  
**718-332**  
 Fig. 31/32



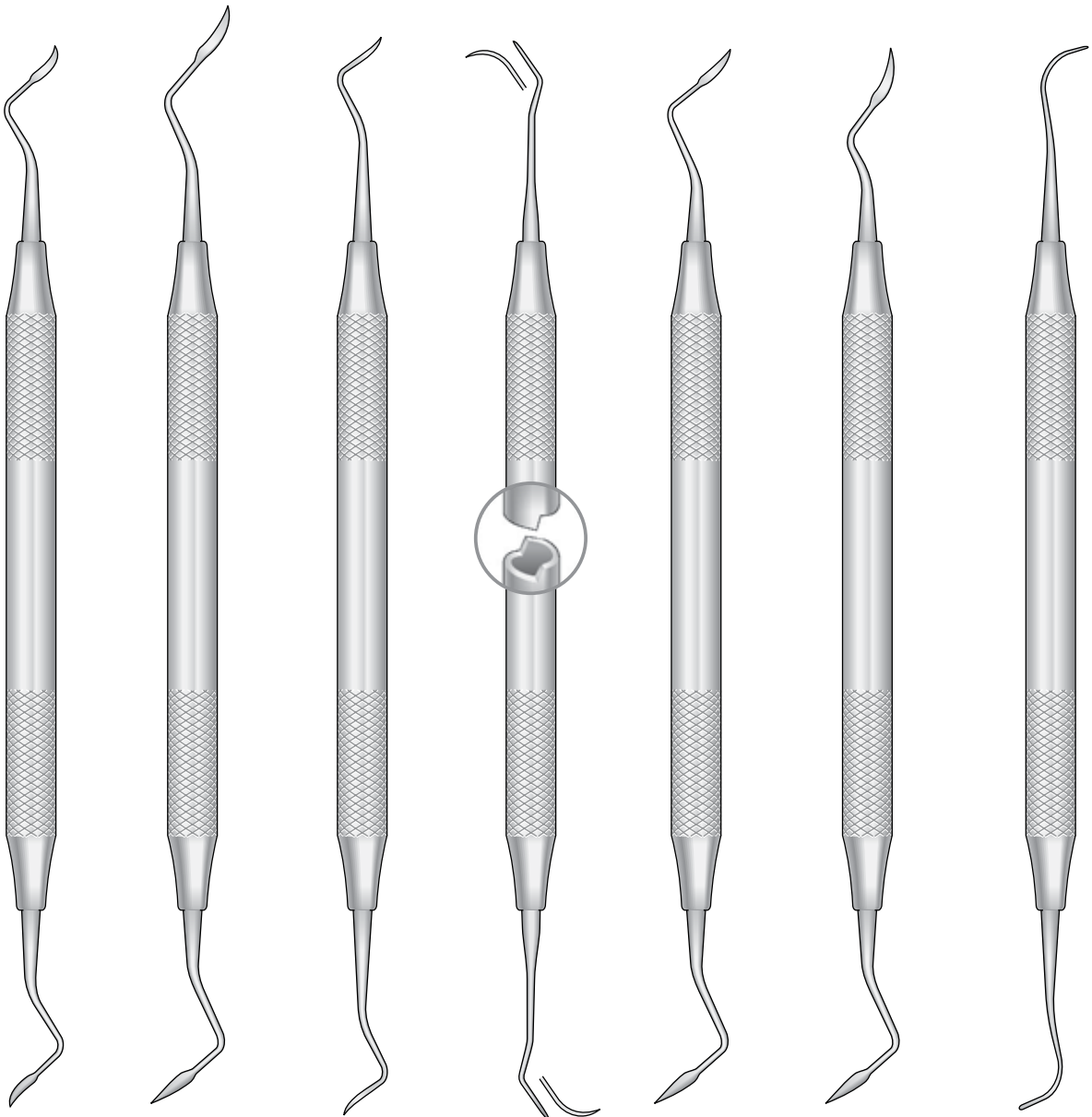
JAQUETTE  
**718-335**  
 Fig. 34/35



PERIOSTEALS  
 CURETTES &  
 BONE



PERIOSTEALS  
CURETTES &  
BONE



TAYLOR  
718-TO3  
Fig. 2/3

718-204  
Fig. 204

718-204S  
Fig. 204S

718-204SD  
Fig. 204SD

718-CIO3  
Fig. 2/3

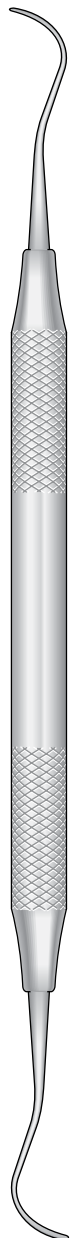
CRANE-CAPLAN  
718-CK6  
Fig. 6

YOUNGER-GOOD  
718-YGO8  
Fig. 7/8





RULE 23/24  
**718-RO4**  
 Fig. 3 /4



I. UNIVERSITY  
**718-268**  
 Fig. 17/18

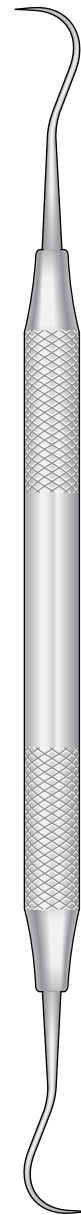


Ø 8 mm  
**Hollow**  
 Hohl  
 Creux  
 Hueco  
 Vuoto

TOWNER-JAQUETTE  
**719-111**  
 Fig. U15/33

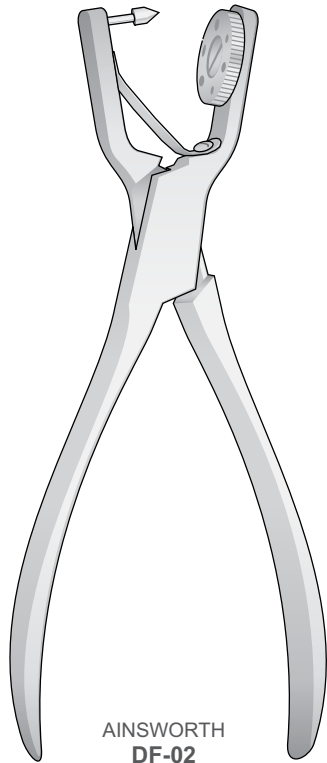


TOWNER-JAQUETTE  
**719-125**  
 Fig. H5/33



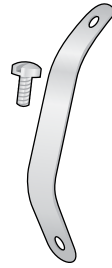
TOWNER-JAQUETTE  
**719-126**  
 Fig. H6/H7

PERIOSTEALS  
 CURETTES &  
 BONE



AINSWORTH  
**DF-02**  
 160 mm

Lochzangen  
 Punch Forceps  
 Pinze foradiga  
 Perforadores  
 Pincès à perforer



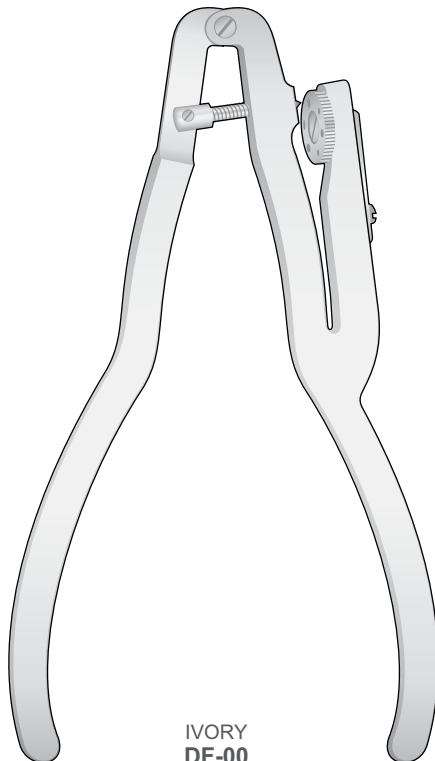
**DF-02M**  
 Feder mit Schraube  
 Spring with screw  
 Molla con vite  
 Muelle con tornillo  
 Ressort avec vis



**DF-02R**  
 Lochscheibe  
 Punch Disk  
 Disco divisore  
 Disco agujereado  
 Disque perforé



**DF-02P**  
 Stift, mit Schraube  
 Pin, with screw  
 Perno con vite  
 Punzòn con perno  
 Broche



IVORY  
**DF-00**  
 160 mm

Lochzangen  
 Punch Forceps  
 Pinze foradiga  
 Perforadores  
 Pincès à perforer



**DF-00M**  
 Spiralfeder  
 Spiral Spring  
 Molla a spirale  
 Muelle espiral  
 Ressort en spirale



**DF-00R**  
 Lochscheibe  
 Punch Disk  
 Disco divisore  
 Disco agujereado  
 Disque perforé

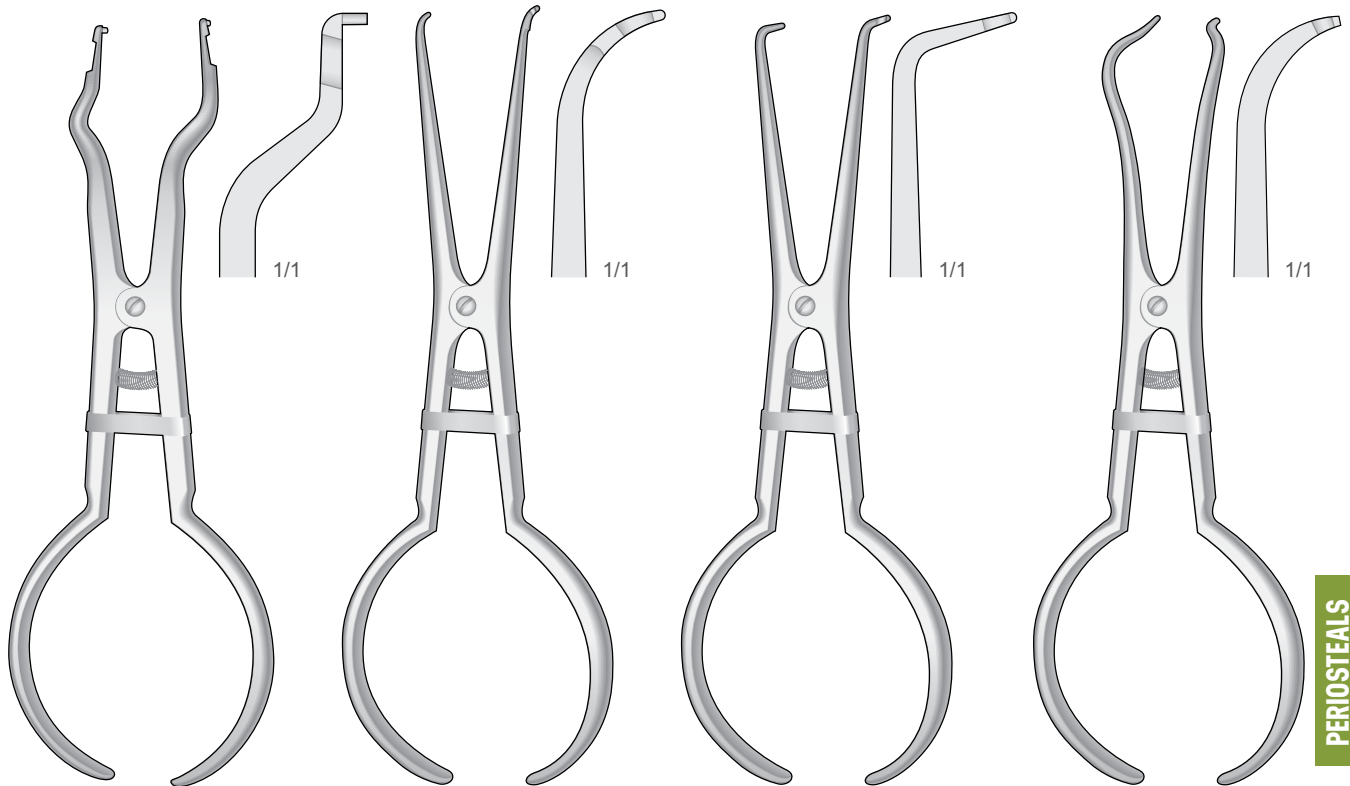


**DF-00L + DF-00V**  
 Feder mit Schraube  
 Spring with screw  
 Molla con vite  
 Muelle con tornillo  
 Ressort avec vis



**DF-00P + DF-00N**  
 Stift, mit Schraube  
 Pin, with screw  
 Perno con vite  
 Punzòn con perno  
 Broche avec vis

Kofferdam-Klammerzangen  
Rubber-Dam Clamp Forceps  
Pinze per uncini  
Pinzas para grapas dique de goma  
Pincers porte-crampons



**BREWER**  
**DF-10**  
170 mm

**PALMER**  
**DF-15**  
170 mm

**STOKE**  
**DF-16**  
170 mm

**DF-18**  
170 mm

PERIOSTEALS  
CURETTES &  
BONE



Molaren, 12 Stück  
 Molars, 12 pieces  
 Molari, 12 pezzi  
 Molares, 12 piezas  
 Molaires, 12 Pièces

Premolaren, 12 Stück  
 Premolars, 12 pieces  
 Premolari, 12 pezzi  
 Premolares, 12 piezas  
 Prémolaires, 12 Pièces



**DF-40/1**  
 Fig.1



**DF-41/4**  
 Fig.4



**DF-40/2**  
 Fig.2



**DF-41/5**  
 Fig.5

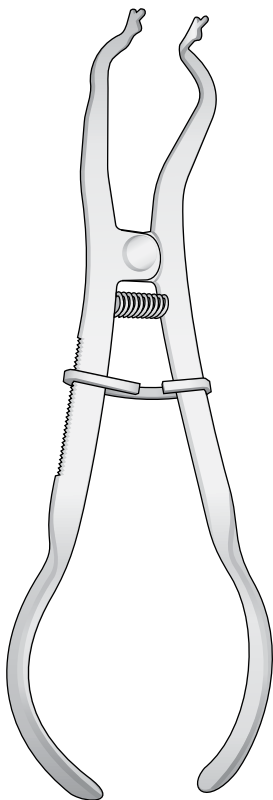


**DF-40/3**  
 Fig.3

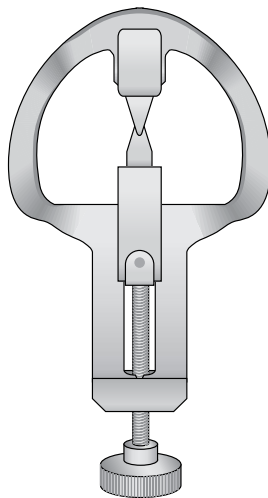


**DF-41/6**  
 Fig.6

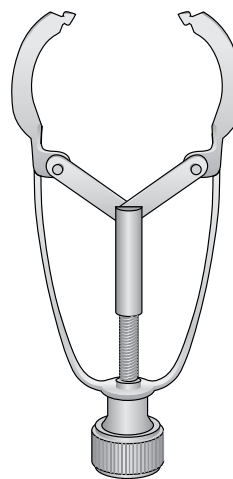
Kofferdam-Klammerzangen  
 Rubber-Dam Clamp Forceps  
 Pinze per uncini  
 Pinzas para grapas dique de goma  
 Pincas porte-crampons



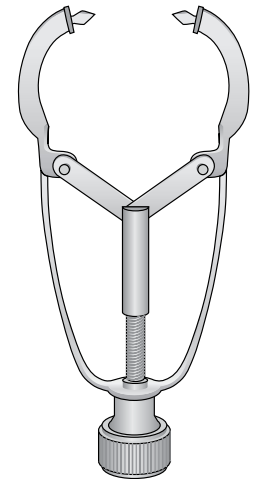
IVORY  
**DF-12**  
 170 mm



IVORY  
**DF-43**  
 Fig. 14



IVORY  
**DF-40**  
 Fig. 1



IVORY  
**DF-41**  
 Fig. 12

Kofferdam Instrumente  
 Rubber-Dam Instruments  
 Strumenti per diga  
 Instrumentos para dique de goma  
 Instruments pour digue de caoutchouc

Kofferdam-Klammern  
 Rubber-Dam Clamps  
 Uncini per diga  
 Clamps para diques  
 Crampons pour digue



IVORY  
**DF-126**  
 # 26



IVORY  
**DF-127**  
 # 27



IVORY  
**DF-128**  
 # 28



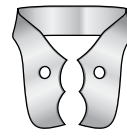
IVORY  
**DF-129**  
 # 29



IVORY  
**DF-130**  
 # 30



IVORY  
**DF-131**  
 # 31



IVORY  
**DF-151**  
 # 51

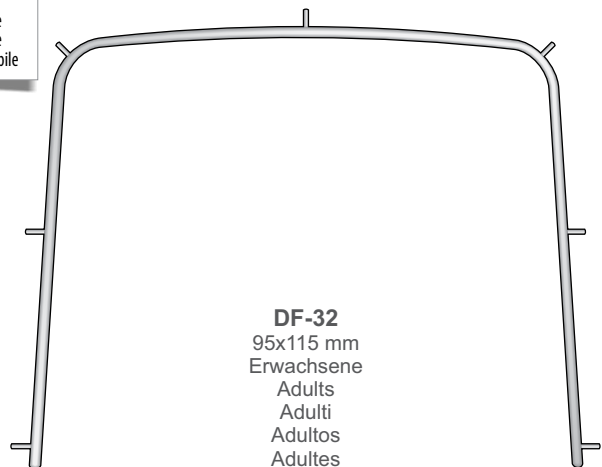


IVORY  
**DF-160**  
 # 60

Kofferdam-Rahmen  
 Rubber-Dam Frames  
 Telaio per diga  
 Cuadro para diques  
 Cadre à digue



**DF-30**  
 80x75 mm  
 Kinder  
 Children  
 Bambini  
 Niños  
 Enfants



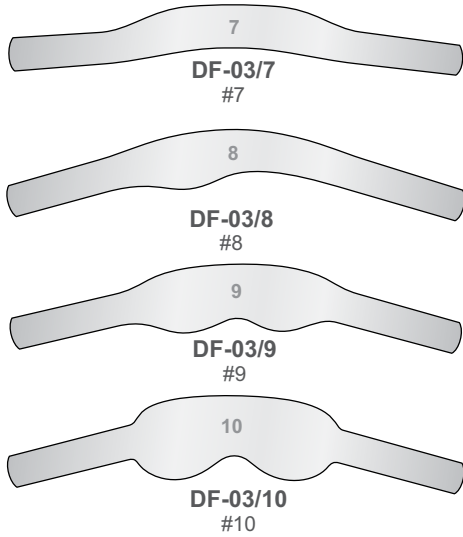
**DF-32**  
 95x115 mm  
 Erwachsene  
 Adults  
 Adulti  
 Adultos  
 Adultes

PERIOSTEALS  
 CURETTES &  
 BONE

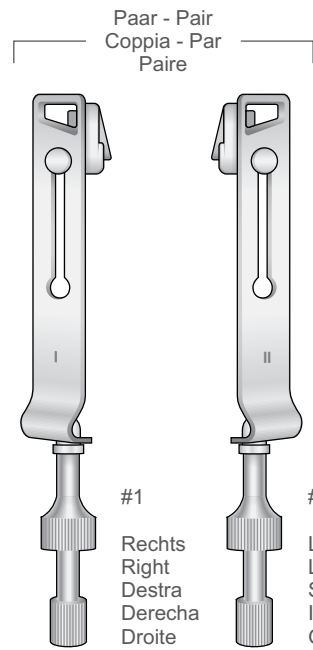
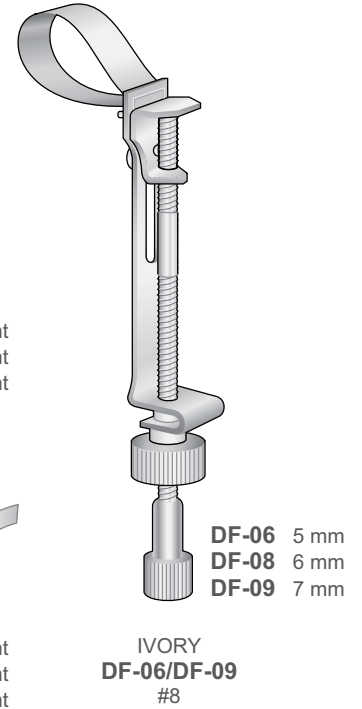
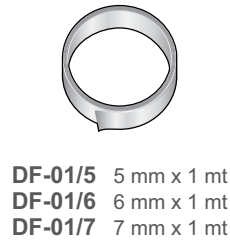
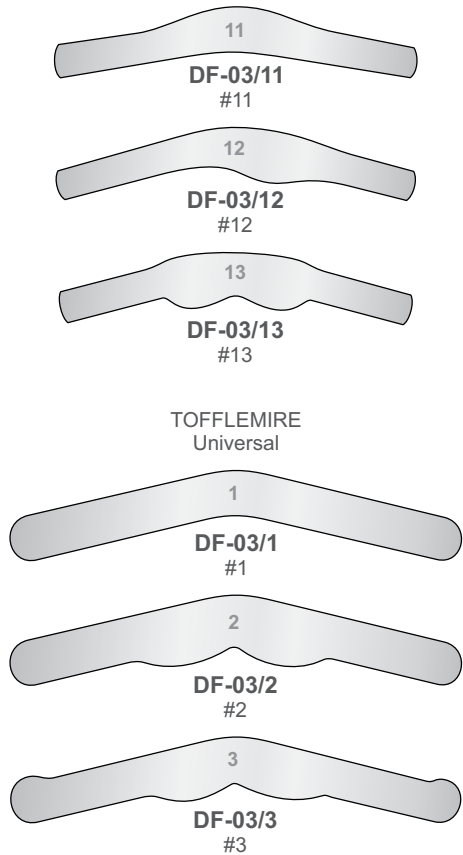


Matrizenspanner und Matrizenbänder  
 Matrix Retainers and Matrix Bands  
 Portamatrici e matrici  
 Portamatrices y bandas matrices  
 Porte-matrices et bagues matrices

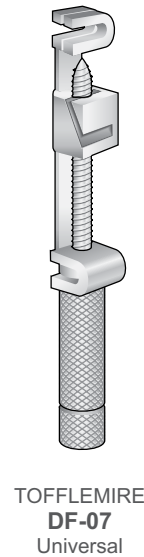
Molaren, 12 Stück  
 Molars, 12 pieces  
 Molari, 12 pezzi  
 Molares, 12 piezas  
 Molaires, 12 Pièces



Premolaren, 12 Stück  
 Premolars, 12 pieces  
 Premolari, 12 pezzi  
 Premolares, 12 piezas  
 Prémolaires, 12 Pièces



NYSTRÖM  
**DF-04**  
 #1 + #2







we take a closer look

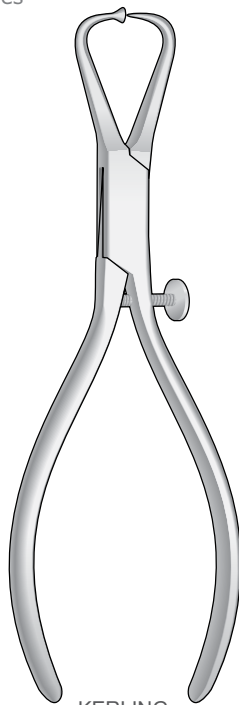
# + CROWN AND BRIDGE



Crown & Bridge  
Instruments

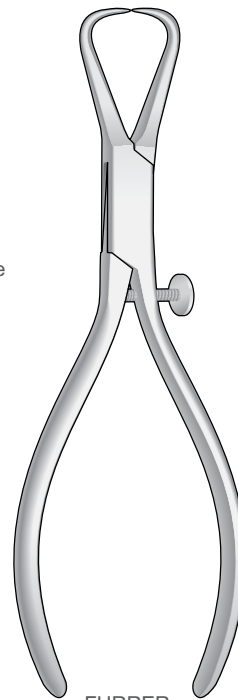


Kroneninstrumente  
 Crown Instruments  
 Pinze per corone  
 Alicates para coronas  
 Pincés pour couronnes

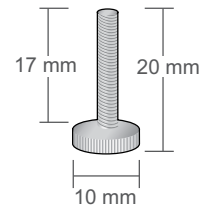


**KERLING  
 DP-38A**  
 145 mm

Kupferringabnehmezange  
 Copper Ring Removing Pliers  
 Pinza per togliere anelli di rame  
 Pinza para sacar anillos de cobre  
 Pince à enlever les bagues en cuivre

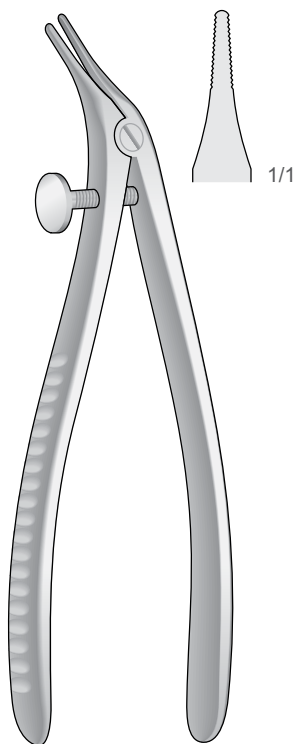


**FURRER  
 DP-38**  
 145 mm

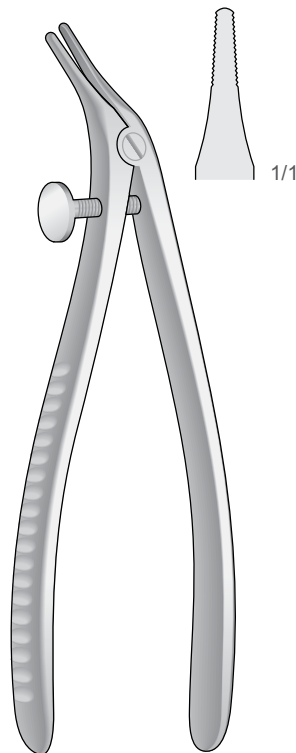


**DP-38R**  
 Schraube  
 Replacement Screw  
 Vite di ricambio  
 Tornillos de recambio  
 Vis de rechange

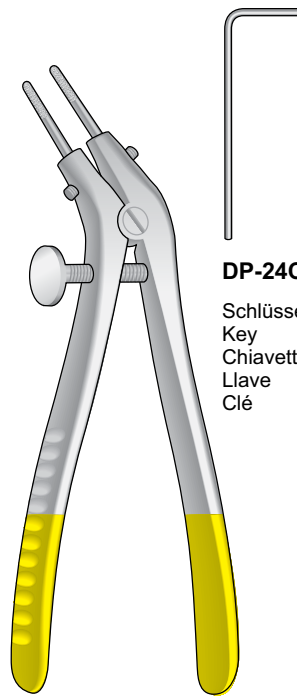
Teleskopkronenzangen - Pliers for telescope crowns  
 Pinze per corone telescopiche - Alicates para coronas telescópicas  
 Pincés pour couronnes telescopes



**BÖHM  
 DP-28**  
 150 mm



**BÖHM  
 DP-29**  
 150 mm



**DP-24**  
 120 mm

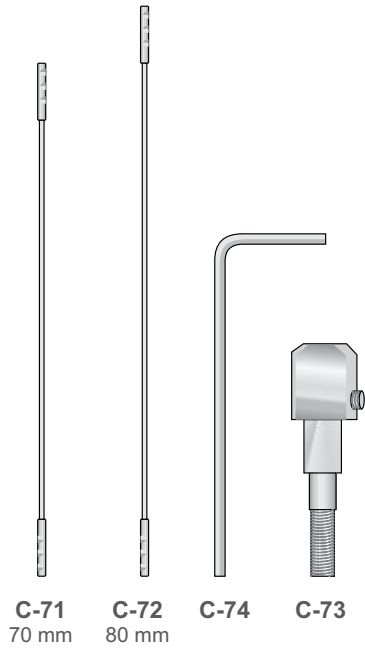


**DP-24C**  
 Schlüssel  
 Key  
 Chiavetta  
 Llave  
 Clé



**DP-24R**  
 Diamantierte Einsätze, paar  
 Diamond inserts, pairs  
 Punte diamantate, coppia  
 Puntas diamantadas, par  
 Pointes diamantées, pair

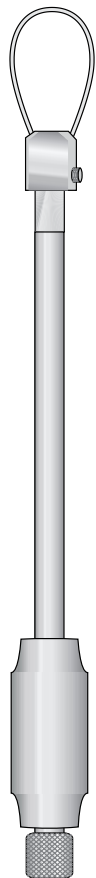
**MRT-C7**  
 Complete Bridge Extractor  
 MRT-7 + C-71 + C-72 + C-73 + C-74



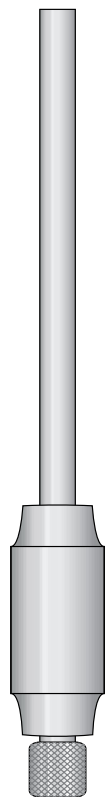
Removing pliers  
 for temporary  
 bridges and crowns



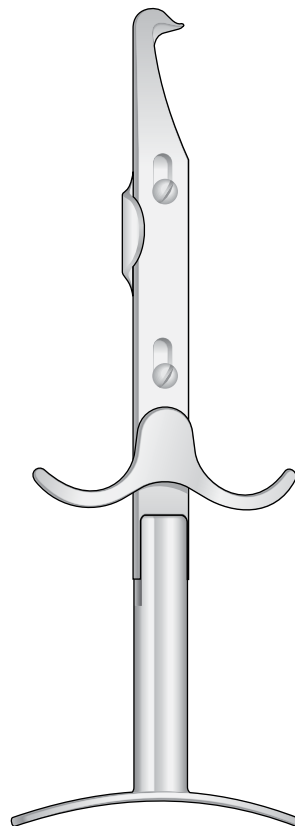
**Tungsten-Carbide Inserts**  
 Mit Hartmetalleinsätzen  
 Plaquettes en carbure de tungstène  
 Plaquetas de carburo de tungsteno  
 Inserti in carburo di tungsteno



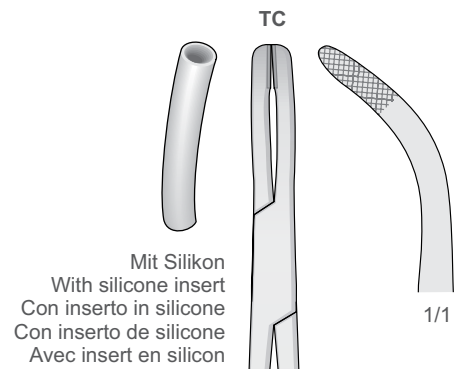
**MRT/C7**



**MRT-7**



**MRT-6**  
 170 mm

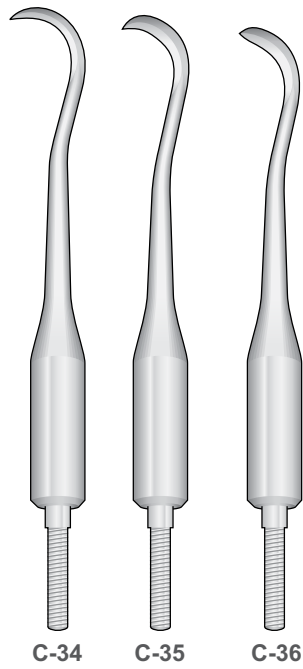


**PH-60**  
 170 mm



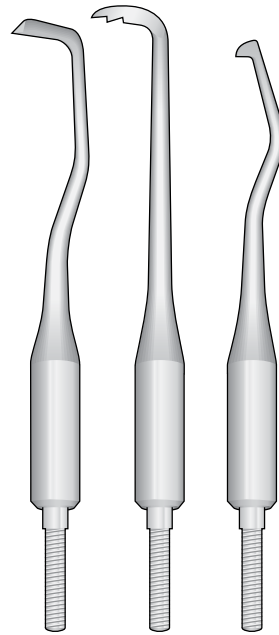
Kronentferner  
 Crown Removers  
 Leva corone  
 Removedor de coronas  
 Enlève-couronne

**MRT-C3**  
 Complete with 3 Attachments  
 C-34 + C-35 + C-36



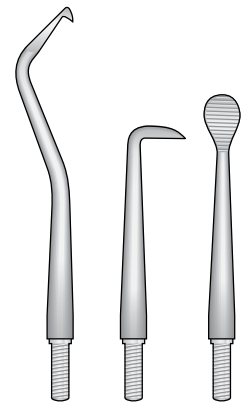
C-34 C-35 C-36

**MRT-C4**  
 Complete with 3 Attachments  
 C-41 + C-42 + C-43



C-41 C-42 C-43

**MRT-C1**  
 Complete with 3 Attachments  
 C-11 + C-12 + C-13

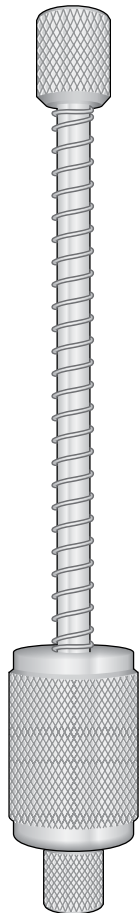


C-11 C-12 C-13



C-30

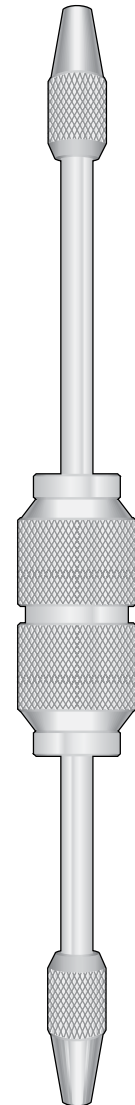
Usando la punta C-30  
 e invertendo la molla  
 si usa come spingicorone



MRT-C3



MRT-C4

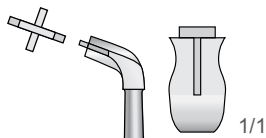


MRT-C1

CROWN  
 & BRIDGE



Kronentferner  
 Crown Removers  
 Leva corone  
 Removedor de coronas  
 Enlève-couronne



UNIVERSAL  
**DL-60**  
 150 mm



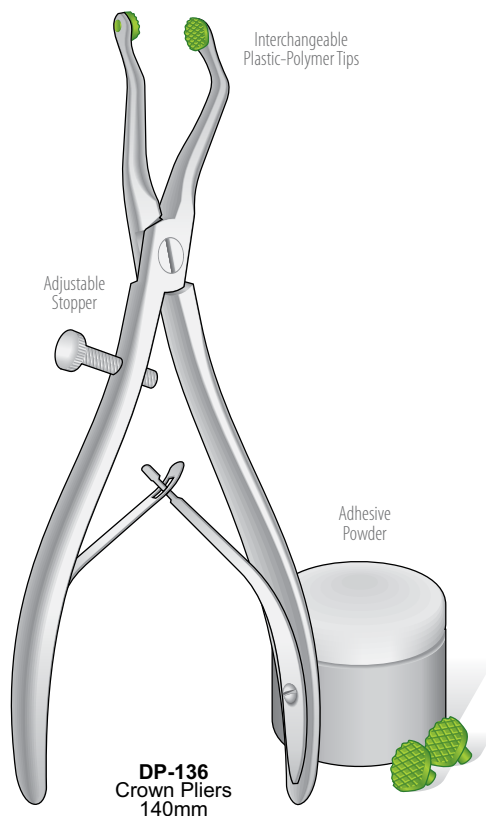
**DL-C**  
 140 mm



**DL-V**  
 130 mm



**DL-0**  
 130 mm



**DP-136**  
 Crown Pliers  
 140mm

**TEMPORARY CROWN PLACEMENT KIT | DP-136**

1 Crown Pliers + 20 Replacement Tips + 10g Adhesive Powder

**Crown Pliers:** designed to remove upper and lower crowns and bridges. An adjustable stopper allows to adjust the grasping tips to the width of the crown and locking into place. It will prevent any unwanted pressures to the crown avoiding potential damages. The double spring back action along with the hook-lock mechanism allows for a smooth grasping motion.

**Polymer Plastic Replacement Tips:** provide a perfect and safely grip for temporary ceramic crowns without damaging metal, resin, or ceramic surfaces. A better grip of the crown can be achieved if the tips are coated with the supplied adhesive powder which is dampened by saliva.

**Adhesive Powder:** denture adhesive used as "glue" for recementing crowns or bridges that have come off.

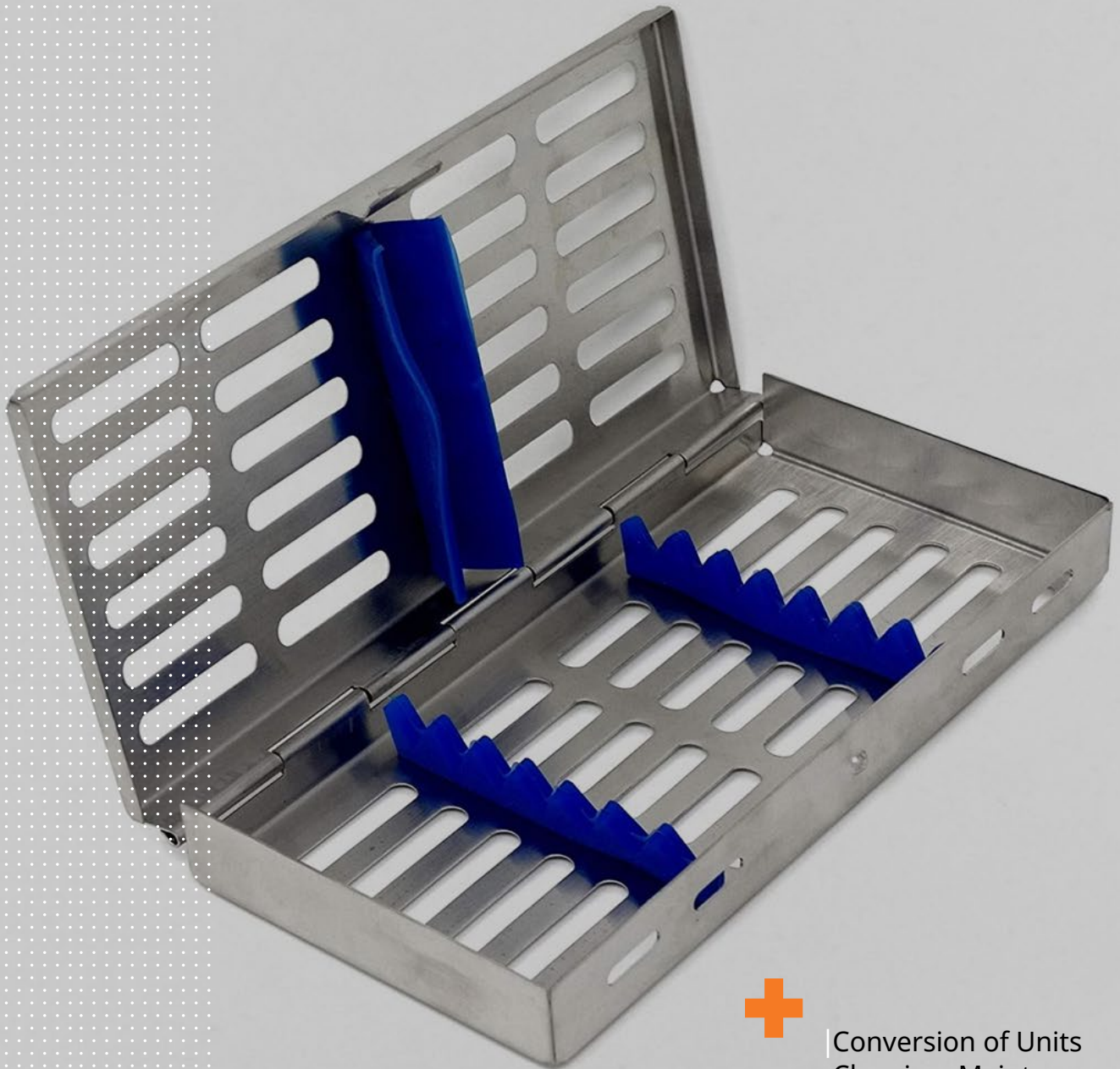
**DP-137 /** Replacement Kit for DP-136: 20 Replacement Tips + 10g Adhesive Powder





we take a closer look

# USEFUL DATA & MAINTENANCE



Conversion of Units  
Cleaning, Maintenance &  
Sterilization  
Maintenance Cycle & Tips





Umrechnung von Einheiten | Conversion des unités | Conversión de unidades | Conversione delle unità

### Temperature / Celsius • Fahrenheit

°C	-18	-10	0	10	20	30	40	50	60	70	80	90	100	110	120	130	140	150	200	250	300	350
°F	0	14	32	50	68	86	104	122	140	158	176	194	212	230	248	266	284	302	392	482	572	662

Length / International System (SI) • English system (Imperial)			French Gauge System		American Wire Gauge			Standard Wire Gauge					
SI	SI	Imperial	in	mm	Charrière	Ø mm	Ø in	AWG	Ø mm	Ø in	SWG	Ø mm	Ø in
1 mm	-	0.0394 in	0.001	0.0254	1	0.33	0.012	0000 (4/0)	11.684	0.4600	7/0	0.500	12.700
1 cm	10 mm	0.3937 in	0.002	0.0508	2	0.67	0.028	000 (3/0)	10.404	0.4096	6/0	0.464	11.786
1 m	1000 mm	1.0936 yd	0.003	0.0762	3	1.00	0.039	00 (2/0)	9.266	0.3648	5/0	0.432	10.973
			0.004	0.1016	4	1.33	0.051	0 (1/0)	8.252	0.3249	4/0	0.400	10.160
			0.005	0.1270	5	1.67	0.067	1	7.348	0.2893	3/0	0.372	9.449
			0.006	0.1524	6	2.00	0.079	2	6.544	0.2576	2/0	0.348	8.839
			0.007	0.1778	7	2.33	0.091	3	5.827	0.2294	0	0.324	8.230
			0.008	0.2032	8	2.67	0.106	4	5.189	0.2043	1	0.300	7.620
			0.009	0.2286	9	3.00	0.118	5	4.621	0.1819	2	0.276	7.010
			0.010	0.2540	10	3.33	0.130	6	4.115	0.1620	3	0.252	6.401
			0.011	0.2794	11	3.67	0.146	7	3.665	0.1443	4	0.232	5.893
			0.012	0.3048	12	4.00	0.157	8	3.264	0.1285	5	0.212	5.385
			0.013	0.3302	13	4.33	0.169	9	2.906	0.1144	6	0.192	4.877
			0.014	0.3556	14	4.67	0.185	10	2.588	0.1019	7	0.176	4.470
			0.015	0.3810	15	5.00	0.197	11	2.305	0.0907	8	0.160	4.064
			0.016	0.4064	16	5.33	0.209	12	2.053	0.0808	9	0.144	3.658
			0.017	0.4318	17	5.67	0.224	13	1.828	0.0720	10	0.128	3.251
			0.018	0.4572	18	6.00	0.236	14	1.628	0.0641	11	0.116	2.946
			0.019	0.4826	19	6.33	0.248	15	1.45	0.0571	12	0.104	2.642
			0.020	0.5080	20	6.67	0.264	16	1.291	0.0508	13	0.092	2.337
			0.021	0.5334	21	7.00	0.276	17	1.15	0.0453	14	0.080	2.032
			0.022	0.5588	22	7.33	0.287	18	1.024	0.0403	15	0.072	1.829
			0.023	0.5842	23	7.67	0.303	19	0.912	0.0359	16	0.064	1.626
			0.024	0.6069	24	8.00	0.315	20	0.812	0.0320	17	0.056	1.422
			0.025	0.6350	25	8.33	0.327	21	0.723	0.0285	18	0.048	1.219
			0.026	0.6604	26	8.67	0.343	22	0.644	0.0253	19	0.040	1.016
			0.027	0.6858	27	9.00	0.354	23	0.573	0.0226	20	0.036	0.914
			0.028	0.7112	28	9.33	0.366	24	0.511	0.0201	21	0.032	0.813
			0.029	0.7366	29	9.67	0.382	25	0.455	0.0179	22	0.028	0.711
			0.030	0.7620	30	10.00	0.394	26	0.405	0.0159	23	0.024	0.610
			0.031	0.7874	31	10.33	0.406	27	0.361	0.0142	24	0.022	0.559
			0.032	0.8128	32	10.67	0.421	28	0.321	0.0126	25	0.020	0.508
			0.033	0.8382	33	11.00	0.433	29	0.286	0.0113	26	0.018	0.457
			0.034	0.8636	34	11.33	0.445	30	0.255	0.0100	27	0.016	0.417
			0.035	0.8890	35	11.67	0.461	31	0.227	0.0089	28	0.015	0.376
			0.036	0.9144	36	12.00	0.472	32	0.202	0.0080	29	0.014	0.345
			0.037	0.9398	37	12.33	0.484	33	0.18	0.0071	30	0.012	0.315
			0.038	0.9652	38	12.67	0.500	34	0.16	0.0063	31	0.012	0.295
			0.039	0.9906	39	13.00	0.512	35	0.143	0.0056	32	0.011	0.274
			0.0394	1.0000	40	13.33	0.524	36	0.127	0.0050	33	0.010	0.254
								37	0.113	0.0044	34	0.009	0.234
								38	0.101	0.0039	35	0.008	0.213
								39	0.089	0.0035	36	0.008	0.193
								40	0.079	0.0031	37	0.007	0.173
								41	0.071	0.0028	38	0.006	0.152
								42	0.064	0.0025	39	0.005	0.132

Volume / Milliliters • Fluid Ounces • Cubic Centimeters					
mL	US oz	US oz	UK oz	UK oz	cc (cm <sup>3</sup> )
1.0	1/32	0.033814	0.035195	1/32	1.0
29.574	1	1.0	13/64	1.0409	29.574

in	cm	mm	in
1	2.54	1	0.0394
2	5.08	2	0.0787
3	7.62	3	0.1181
4	10.16	4	0.1575
5	12.7	5	0.1969
6	15.24	6	0.2362
7	17.78	7	0.2756
8	20.32	8	0.3150
9	22.86	9	0.3543
10	25.40	10	0.3937
11	27.94	11	0.4331
12	30.48	12	0.4724
13	33.02	13	0.5118
14	35.56	14	0.5512
15	38.10	15	0.5906
16	40.64	16	0.6299
17	43.18	17	0.0669



# Cleaning, Maintenance & Sterilization

## Sharpen • Lubricate



**DB-4**

### Rectangular Stone

A flat and rectangular stone used to sharpen all cutting parts of surgical instruments. Necessary in routine sharpening and finishing of edge and toe of an instrument.

**Arkansas # 4**  
100 x 25 x 12 mm  
4 x 1 x 0.5 in



**DB-96**

### Flat Stone

A flat and rectangular stone used to sharpen all cutting parts of scissors, osteotomes, curettes, etc. (whenever necessary).

**Arkansas # 8**  
100 x 50 x 13 mm  
4 x 2 x 0.5 in



**DB-299**

### Conical Stone

A cone-shaped and cylindrical stone used to manually sharpen internal parts of curettes, scalars, gouges, rongeurs, etc. (in areas that otherwise cannot be reached).

**Arkansas # 299**  
Ø 8 x 90 mm  
Ø 0.3 x 3.5 in



**DB-3**

**DB-6A**

### Wedge Stones

They combine flat surfaces with rounded edges to manually sharpen internal parts (straight and curved edges) of curettes and scalars.

*Arkansas:* for routine sharpening and finishing.

*India:* for sharpening of excessively dull instruments or those requiring recontouring.

**India # 6**  
100 x 45 mm  
4 x 1.8 in  
Medium grit

**Arkansas # 6A**  
100 x 45 mm  
4 x 1.8 in  
Fine texture

• *Arkansas:* a natural stone extracted from the Arkansas mountains. • *India:* a synthetic stone quarried from the finest Ozark novaculite - silicon quartz- deposits.



**DB-71**

### Ceramic Stone

Ceramic stones (autoclavable) are valued for their durability and the very keen edge they give in the finer grits. Will never pit or groove. Used for routine sharpening procedures.

*Use only dry*  
(do not use with oil, water or lubricants)

76 x 25 x 6 mm / 3 x 1 x 1/4 in



**DB-15**

### Plastic Stick for sharpening test

A hard plastic stick used to test the blade of an instrument to determine the sharpness of an instrument. Must be used ALWAYS.

If the blade of the instrument runs smoothly over the plastic stick, then it is blunt. A sharp instrument will grab into the stick and removes small fragments of the plastic.

Ø 7 x 75 mm / Ø 0.28 x 3 in



**DB-OL**

### Lubricating & Sharpening Oil for surgical instruments

A non-coloured oil, which is an indispensable complement for lubricating and manual sharpening of surgical instruments. To activate the abrasive properties of Arkansas or India stones and to reduce the possibility of overheating the instruments during sharpening. It should be applied on all hinges or all other parts which are subject to movement or friction. Its use facilitates elimination of any residue present within the instrument hinges. Used to ensure perfect function and fluid movement of all surgical instruments.

Must ALWAYS be used during all sharpening operations.

30 cc / 1 fl oz

## Rinse • clean



### CLEANLACT | Detergent Milk

Concentrated milk. Bacteriostatic detergent, rust inhibitor and lubricating action on all surgical instruments. It guarantees perfect maintenance by eliminating eventual stains, halos and browning due to sterilization, disinfection and washing with tap water.

Must be applied periodically, diluted or concentrated to extends your instrument's lifetime (view special instructions on packaging).

**DB-1L**

1000 cc  
34 fl oz

**DB-50M**

500 cc  
17 fl oz

**DB-10M**

250 cc  
8.5 fl oz



**DB-11**

155 mm  
6 in

### Cleaning Brushes

Special brushes (autoclavable) to clean surgical instruments. Used to remove eventual residue, organic or not, from all surgical instruments, in particular in angled, hinged and knurled parts, without damaging instrument surface.

Must be applied every time, for regular cleaning of all instrumentation and in the event that an instrument is exposed for an extended period to air before being immersed in the cleaning solution.



**DB-12**

175 mm  
7 in

### Anti-Stain Rubber for metal

An abrasive eraser specially designed for surgical instruments to remove stains, halos or persistent burnishing from all surgical instruments without damaging the instrument surface.

Necessary when routine cleaning does not remove all stains.



**DB-08**

50 x 40 x 20 mm / 2 x 1.6 x 0.8 in  
Coarse

**DB-07**

Fine

## Sterilization Cassettes • Stainless steel trays with silicone racks

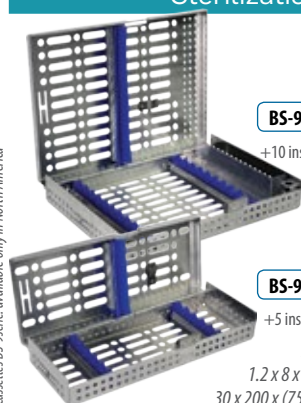
## Coding

### Silicone Code Rings



**DB-941**

120 Items



**BS-910<sup>B</sup>**

+10 instrum.

**BS-920<sup>D</sup>**

+20 instrum.

**BS-905<sup>A</sup>**

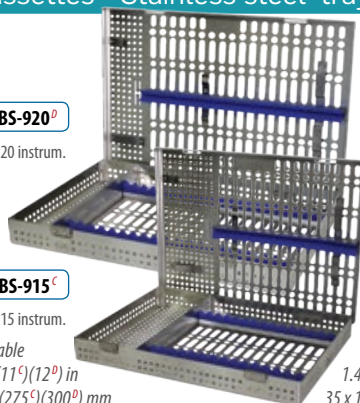
+5 instrum.

**BS-915<sup>C</sup>**

+15 instrum.

Autoclavable

1.2 x 8 x (3<sup>4</sup>)(6<sup>8</sup>)(11<sup>9</sup>)(12<sup>9</sup>) in  
30 x 200 x (75<sup>9</sup>)(150<sup>9</sup>)(275<sup>9</sup>)(300<sup>9</sup>) mm



**BS-59<sup>E</sup>**

+5 instrum.

**BS-60<sup>F</sup>**

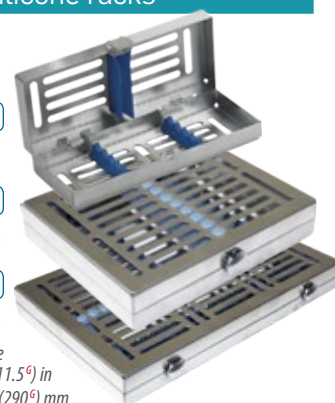
+10 instrum.

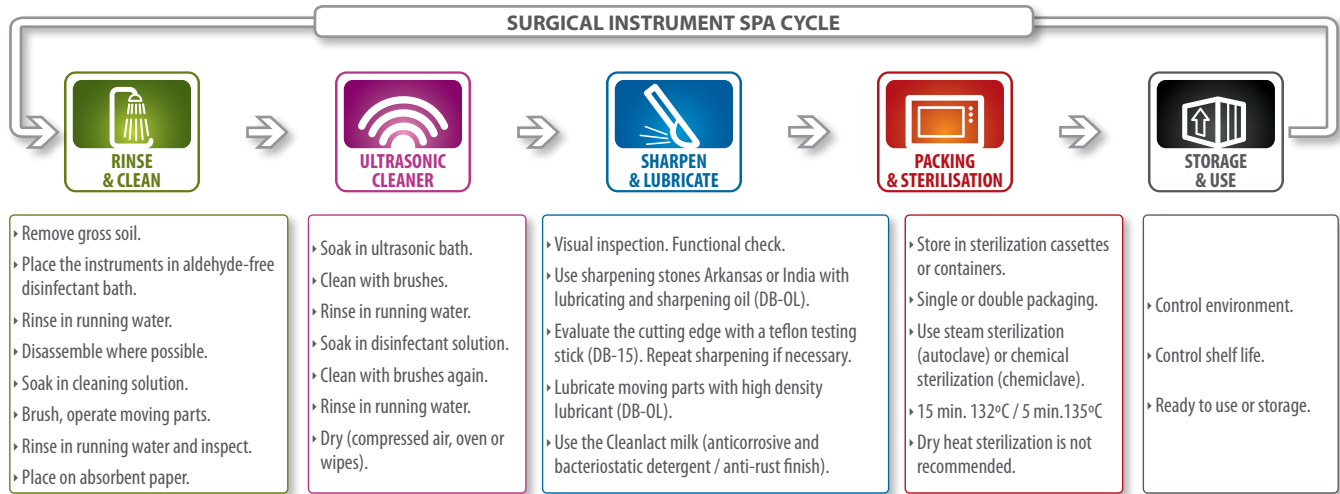
**BS-61<sup>G</sup>**

+20 instrum.

Autoclavable

1.4 x 7 x (3<sup>5</sup>)(5.7<sup>5</sup>)(11.5<sup>6</sup>) in  
35 x 185 x (75<sup>5</sup>)(145<sup>5</sup>)(290<sup>6</sup>) mm





## RINSE AND CLEAN

Immediately after surgery, rinse instruments under warm running water (not hot). Use only neutral detergent (pH=7).

## ALWAYS SHARPEN YOUR INSTRUMENTS

**Why?** Surgical Instruments should be kept identical to their original design. Surgical procedures are most effective when using sharp instruments as they reduce hand and wrist fatigue, improve calculus removal, save time, improve tactile sensitivity, and minimize patient discomfort.

**When?** Instruments should be sharpened lightly after each use; there are two ways to evaluate whether the cutting edge is dull and requires sharpening:

- Visual:** The cutting edge should be inspected regularly in a good light (and if possible, under magnification). If the cutting edge is blunt it will be rounded and reflect the light. A dull, non-reflective line indicates sharpness.
- Teflon Test Stick (DB-15):** If the blade of the instrument runs smoothly over the testing stick, then it is blunt. A sharp instrument will grab into the stick and removes small fragments of the plastic.

**How?** The instruments should be sharpened following this procedure:

- Place one drop of sharpening oil (**DB-OL**) on the **Arkansas** sharpening stone. Lubrication improves the movement of the instrument blade over the stone; also, it prevents the metal particles from clogging the stone.
- Hold the instrument in one hand, while applying the stone to the lateral surface angled with the face of the blade.
- Position the stone to contact the heel of the blade and work toward the tip, keeping the stone in contact with the blade throughout the sharpening procedure.
- Move the stone up and down with short strokes, placing more pressure on the down stroke (do not move the instrument, keep the instrument still).
- Always finish instrument sharpening with a down stroke; this will prevent a rough edge from forming and remove any flash of metal.
- Evaluate the sharpness with teflon test stick (**DB-15**). If the blade is still dull, re-evaluate the angle of the stone and repeat the sharpening (steps 2-6).

*Sharp, delicate and TC instruments  
Scissors, needle holders or bone forceps should be cleaned manually by using cleaning brushes.*

*Lubrication  
Regular use of DB-OL lubricant oil and "Cleanlact" detergent milk, will prevent rust, corrosion, and stiff joints.*

*TC instruments  
Tungsten carbide instruments are more sensitive to chemicals and require special care. They should never be exposed to chemical substances or to any other corrosive chemicals.*

*Sharpening  
Regular sharpening will enhance the life of your cutter and will improve the quality of your work.*

*Ultrasound cleaning  
It is not recommended for scissors, needle holders, bone forceps and all tungsten carbide instruments.*

## ULTRASONIC CLEANING

It is recommended for regular instruments such as hand instruments and extraction forceps, following this procedure:

- Sort instruments carefully so as to include only instruments compatible with ultrasonic cleaning. Do not combine different metals (stainless, copper, chrome plated, etc.).
- Place instruments in open position. Make certain sharp edges are not touching other instruments.
- Change solution frequently to avoid accumulation of micro organisms.
- After rinsing and before sterilization, inspect and dry the instruments thoroughly.

**⚠** Ultrasonic cleaning does not sterilize. Do not use for TC instruments, sharp and delicate instruments.

## SHARPENING OF SCALERS AND CURETTES

**Sickle Scaler Toe End:** the sickle scaler has a pointed tip and, therefore, the stone is held straight as it nears the tip.

**Curette Toe End:** the curette has a rounded toe, so the position of the stone is adapted around the rounded cross-section.

**⚠** Always finish instrument sharpening with a down stroke; this will prevent a rough edge from forming and remove any flash of metal.

## CARE OF SHARPENING STONES

After use, wipe the stone with a clean cloth to remove metal particles. Then, clean the stone by scrubbing or using ultrasound to remove lubricant before sterilization. After sterilization, lubricate with **DB-OL** before each use.

**⚠** Be sure to use entire stone to prevent "grooving".

## STERILIZATION

### Autoclave (Steam Sterilization)

Time and temperature: 15 min. 132°C (270°F) / 5 min. 135°C (275°F)

### Chemiclave (Chemical Sterilization)

Time and temperature: 15 min. 132°C (270°F) / 5 min. 135°C (275°F)

### Dry Heat Sterilization (not recommended)

Time and temperature: 90 min. 160°C (320°F) / 60 min. 170°C (340°F)

**⚠** Sterilization cannot substitute cleaning.







we take a *closer* look

# +

# INDEX



| Alphanumeric  
Codes



# Alphanumeric Codes

CODE	PP.	ID	CODE	PP.	ID	CODE	PP.	ID	CODE	PP.	ID
7	3		712-122	293		718-3/4	302	GRACEY	720-103	232	HEMINGWAY
8	8		712-122L	293		718-4R	303	COLUMBIA	720-104	232	HEMINGWAY
13	6		712-123	293		718-5/6	302	GRACEY	720-111	239	WAHL
17	3		712-123L	293		718-7/8	302	GRACEY	720-112	239	WAHL
18	3		712-124	293		718-9/10	302	GRACEY	725-1/2	47	HEIDBRINK
21	8		712-124L	293		718-11MD	303	GRACEY	725-3/4	47	HEIDBRINK
22-1/2L	11		712-125L	293		718-11/12	302	GRACEY	725-3/4S	47	HEIDBRINK
22-1/2R	11		712-131	295		718-13MD	303	GRACEY	725-5/6	47	HEIDBRINK
22	6		712-132	295		718-13/14	302	GRACEY	A-1	275	
29	4		712-133	295		718-14	303	COLUMBIA	AL-MA5	257	
30	4		712-161H	294		718-24G	229		AM-1	24	
33	6		712-162H	294		718-103	286	OCHSENBEIN	AM-5	31	PHYSICK
33A	6		712-163H	294		718-104	286	OCHSENBEIN	AM-15	30	HARRIS
46L	12		712-164H	294		718-107	286	RHODES	AM-16	30	
48	12		712-171	295	WESTCOTT	718-113	286		AM-17	29	
49	12		712-172	295	WESTCOTT	718-123	301	KIRKLAND	AM-18L	27	HARRIS
51	5		712-182	295	LADMORE	718-133	301	ORBAN	AM-18R	27	HARRIS
51A	5		712-183	295	LADMORE	718-147	301	GOLDMAN-FOX	AM-23	29	
51L	5		712-191	296		718-148	301	GOLDMAN-FOX	AM-24	27	
55	10		712-192	296		718-149	301	GOLDMAN-FOX	AM-32	26	PARMLY
56	10		712-201	296		718-151	301	GOLDMAN-FOX	AM-32A	26	PARMLY
67A	5		712-202	296		718-154	301	BUCK	AM-53L	25	
68	10		712-221	296		718-156	301	BUCK	AM-53R	25	
68A	10		712-222	296		718-162	301	SANDERS	AM-62	24	
73	6		712-223	296		718-165	301	SANDERS	AM-65	26	
74	7		712-231	296		718-170	301	USC TOWNER	AM-69	28	TOMES
74N	7		712-232	296		718-191	228	HOPKINS	AM-88L	25	NEVIUS
75	7		712-233	296		718-192	228	HOPKINS	AM-88R	25	NEVIUS
76S	4		712-241	229,295	WOODSON	718-204	306		AM-101	28	HULL
79	8		712-242	295	WOODSON	718-204S	306		AM-103	30	
79A	8		712-243	295	WOODSON	718-204SD	306		AM-150	24	CRYER
86A	7		712-251	296		718-210	239	SCHLUGER	AM-150A	24	CRYER
87	9		712-256	296		718-212	239	BUCK	AM-150AS	33	
89	9		712-259	296		718-212S	239	SUGARMAN	AM-150S	33	CRYER
90	9		712-PFI	294		718-214S	239	SUGARMAN	AM-150X	32	
707-1N	290	NABERS	713-101	299		718-215	204	OBWEGESER-FREER	AM-151	28	
707-2N	290	NABERS	713-102	299		718-216	204	OBWEGESER-FREER	AM-151AS	33	
707-3GF	289	GOLDMAN-FOX	714-101	294		718-223	228	MEAD	AM-151S	33	CRYER
707-3UM	290	UNIV. MICHIGAN	714-102	294		718-232	303	LANGER	AM-151X	32	
707-3W	289	WILLIAMS	714-CV11	299		718-234	303	LANGER	AM-203	29	
707-6D1	288		715-101	297	HOLLENBACK	718-251	303	DE MARCO	AM-210	27	
707-6D2	288		715-102	297	HOLLENBACK	718-252	303	DE MARCO	AM-222	31	
707-6D3	288		715-103	297	HOLLENBACK	718-268	307	I. UNIVERSITY	AM-250	31	COHEN
707-16D1	288		715-103S	297	HOLLENBACK	718-271	304	GOLDMAN-FOX	AM-451	9	
707-16D2	288		715-311	291	IPC	718-272	304	GOLDMAN-FOX	AMG-150	34	CRYER
707-16GF	289	GOLDMAN-FOX	715-312	291	IPC	718-273	304	GOLDMAN-FOX	AMG-150S	34	CRYER
707-16UM	290	UNIV. MICHIGAN	715-404	297	HOLLENBACK	718-274	304	GOLDMAN-FOX	AMG-151	34	CRYER
707-16W	289	WILLIAMS	715-408	297	HOLLENBACK	718-275	304	GOLDMAN-FOX	AMG-151S	34	CRYER
707-17GF	289	GOLDMAN-FOX	716-101	299		718-277	304	GOLDMAN-FOX	APICAL-1	52	APICAL
707-17UM	290	UNIV. MICHIGAN	716-102	299		718-282	305	McCALL	APICAL-2	52	APICAL
707-17W	289	WILLIAMS	716-103	299		718-282A	305	McCALL	APICAL-3	52	APICAL
707-23D1	288		716-104	299		718-284	305	McCALL	APICAL-4	52	APICAL
707-23D2	288		716-201	298	BLACK	718-284S	305	McCALL	AT-1	268	
707-23GF	289	GOLDMAN-FOX	716-202	298	BLACK	718-288S	305	McCALL	AT-2L	268	
707-23UM	290	UNIV. MICHIGAN	716-203	298	BLACK	718-332	305	JAQUETTE	AT-2R	268	
707-23W	289	WILLIAMS	716-204	298	BLACK	718-333	305	JAQUETTE	AT-6	268	
707-202	288		716-211	298	BLACK	718-335	305	JAQUETTE	AT-12	268	MITCHEL
707-202A	288		716-212	298	BLACK	718-C103	306		B-3	281	
707-203	288		716-232	298	WEDELSTAEDT	718-CK3	301	CRANE-KAPLAN	B-4	281	
707-2311	290	WILLIAMS	716-234	298	WEDELSTAEDT	718-CK6	306	CRANE-KAPLAN	B-28/29	281	WHITE
707-2312	290	WILLIAMS	716-236	298	WEDELSTAEDT	718-EN1	229		B-31/32	281	WHITE
707-GFW	289	GOLD.-FOX-WILLIAMS	717-6	300		718-EN2	229		B-32	281	WHITE
707-UT1	288		717-14	300		718-EN3	229		B-33	281	WHITE
711-301	291	HEIDEMANN	717-17	300		718-GF14	227	GOLDMAN-FOX	B-34	281	WHITE
711-302	291	HEIDEMANN	717-17W	300		718-M23	267		B-35	281	BENNET
711-303	291	HEIDEMANN	717-18	300		718-M23A	267		BB-46	75	
712-18	292		717-18W	300		718-M23B	267		BB-48	75	
712-27S	292		717-19	300		718-M8	227	MOLT	BD-01	120	COLLEGE
712-29	292		717-19W	300		718-M9	226	MOLT	BD-02	120	COLLEGE
712-101	292		717-31L	300		718-PR3	226	PRICHARD	BD-03	120	COLLEGE
712-102	292		717-32L	300		718-R0-4	307		BD-04	124	GRAEFE
712-103	292		717-33L	300		718-T03	306	TAYLOR	BD-05	124	PERRY
712-104	292		717-39	300		718-YG08	306	YOUNGER-GOOD	BD-06	124	
712-105	292		717-64	300		719-111	307	TOWNER-JAQUETTE	BD-07	124	GRAEFE
712-106	292		717-66	300		719-125	307	TOWNER-JAQUETTE	BD-09	134	
712-111	293		717-100	300		719-126	307	TOWNER-JAQUETTE	BD-09T	118	
712-111L	293		717-101	300		720-85	232	LUCAS	BD-10	125	
712-112	293		717-102	300		720-85Z	232	LUCAS	BD-11	120	CAULK
712-112L	293		717-103	300		720-86	232	LUCAS	BD-14	135	POTTS-SMITH
712-113	293		717-104	300		720-86Z	232	LUCAS	BD-16	125	
712-113L	293		717-111	300		720-87	232	LUCAS	BD-18	134	
712-120L	293		717-112	300		720-88	232	LUCAS	BD-19	128	
712-121	293		718-1/2	302	GRACEY	720-101	232	HEMINGWAY	BD-20	134	
712-121L	293		718-2R	303	COLUMBIA	720-102	232	HEMINGWAY	BD-21	128	



# Alphanumeric Codes

CODE	PP.	ID	CODE	PP.	ID	CODE	PP.	ID	CODE	PP.	ID
BD-23	134		BD-207	114	ADSON	BF-10	167	GROSS	BT-80	182	MIDDELORPF
BD-25	134		BD-208	114	ADSON	BF-12	167	GROSS	BT-81	182	MIDDELORPF
BD-26	134		BD-209	114	ADSON	BF-20	167	LISTER	BT-82	182	MIDDELORPF
BD-27	138	RUSSIAN	BD-210	137		BF-22	167	PEAN-MURPHY	BT-90	182	KIRSCH
BD-30	132	ADSON	BD-211	137		BF-23	167	PEAN-MURPHY	BT-91	182	KIRSCH
BD-30T	118	ADSON	BD-212	137		BF-24	167	PEAN-MURPHY	BT-92	183	OBWEGESER
BD-31	132	ADSON	BD-213	137		BF-25	167	PEAN-MURPHY	BT-93	183	OBWEGESER
BD-31T	118	ADSON	BD-216	137	SEMKEN	BF-38	165	SCHAEDEL	BT-94	183	OBWEGESER
BD-32	124		BD-217	137	SEMKEN	BF-40	165	FAURE	BT-95	183	OBWEGESER
BD-33	124		BD-221	137		BF-41	165	BACKHAUS	BT-96	183	OBWEGESER
BD-35	124		BD-222	137		BF-42	165	BACKHAUS	BT-100	183	OBWEGESER
BD-36	124		BD-223	137		BF-43	165	BACKHAUS	BT-109	180	LAHEY
BD-38	128		BD-224	137		BF-44	165	BACKHAUS	BT-117	179	KOCHER
BD-39	128		BD-230	136	ADSON	BF-45	165	BACKHAUS	BT-118	179	KOCHER
BD-40	127		BD-231	136	ADSON	BF-46	165	BACKHAUS	BT-131	194	GREENE
BD-41	127		BD-232	136	WANGENSTEEN	BF-48	165	JONES	BT-132	194	
BD-42	127		BD-240	126		BF-50	166	LORNA	BT-134	181	DOCKHORN
BD-43	127		BD-241	126		BF-52	166		BT-135	181	DOCKHORN
BD-44	127		BD-242	126		BF-75	166		BT-139	180	KOCHER
BD-45	127		BD-243	126		BF-94	167	GROSS	BT-140	180	KOCHER
BD-46	127		BD-244	126		BF-95	167	GROSS	BT-152	183	OBWEGESER
BD-47	127		BD-245	126		BM-01	157	OLSEN-HEGAR	BT-153	183	OBWEGESER
BD-51	133	BEASLEY-BABCOCK	BD-246	126		BM-02	157	OLSEN-HEGAR	BT-154	183	OBWEGESER
BD-53	135	POTTS-SMITH	BD-247	126		BM-03	157	OLSEN-HEGAR	BT-155	183	OBWEGESER
BD-56	130		BD-248	126		BM-04	157	OLSEN-HEGAR	BT-156	183	OBWEGESER
BD-57	130		BD-249	126		BM-61	150	OLSEN-HEGAR	BT-157	183	OBWEGESER
BD-58	130		BD-250	136	ADSON	BM-62	150	OLSEN-HEGAR	BT-158	192	MISCH
BD-59	130		BD-251	136	ADSON	BM-63	150	OLSEN-HEGAR	BT-159	192	MISCH
BD-60	126		BD-253	114	ADSON-BROWN	BS-59	322		BT-183	225	HENAHAN
BD-61	126	STILLE	BD-267	137	DE BAKEY	BS-60	322		BT-184	225	HENAHAN
BD-62	126		BD-270	125		BS-61	322		BT-185	225	HENAHAN
BD-63	126	STILLE	BD-270T	118		BS-905	322		BT-186	177	LANGENBECK
BD-65	126	STILLE	BD-271	134		BS-910	322		BT-187	177	LANGENBECK
BD-67	126	STILLE	BD-272	134		BS-915	322		BT-188	177	LANGENBECK
BD-70	132	ADSON	BD-273	134		BS-920	322		BT-189	177	LANGENBECK
BD-71	122,132	ADSON	BD-274	134		BT-07	225		BT-210	177	JOSEPH
BD-72	132	ADSON	BD-275	134		BT-07M	225		BT-211	177	JOSEPH
BD-73	122,132	ADSON	BD-276	134		BT-1	179	HURD	BT-212	177	JOSEPH
BD-75	125		BD-279	123	McINDOE	BT-2	179	HURD	BT-213	177	JOSEPH
BD-75T	118		BD-280	123	GILLIES	BT-05	225	HENAHAN	BT-214	177	JOSEPH
BD-76	125		BD-281	128		BT-06	225	HENAHAN	BT-260	184	LANGENBECK
BD-80	122	DE BAKEY	BD-282	128	ADSON-BROWN	BT-07	225	HENAHAN	BT-264	181	
BD-80T	118	DE BAKEY	BD-283	123	McINDOE	BT-07M	225	HENAHAN	BT-265	181	
BD-81	122	DE BAKEY	BD-284	123	GILLIES	BT-15	177	GILLIES	BT-283	190	ROUX
BD-82	122	DE BAKEY	BD-285T	118		BT-16	177	GILLIES	BT-284	190	ROUX
BD-83	122	DE BAKEY	BD-287	135	POTTS-SMITH	BT-18	179	SEAN-MILLER	BT-285	190	ROUX
BD-90	131	ADSON	BD-288	135	POTTS-SMITH	BT-19	179	SEAN-MILLER	BT-286	190	ROUX
BD-91	127	SEMKEN	BD-289	135	POTTS-SMITH	BT-20	190	FARABEUF	BT-287	190	ROUX-MAGNUS
BD-92	131	ADSON-BROWN	BD-290	135		BT-25	190	FARABEUF	BT-288	190	ROUX-MAGNUS
BD-93	131	ADSON-BROWN	BD-291	135		BT-26	180	RAGNELL-DAVIS	BT-289	190	ROUX-MAGNUS
BD-94	131	BROWN	BD-292	135		BT-27	180	RAGNELL	BV-23	220	WEITLANER
BD-95	127	SEMKEN	BD-348	114	CASTROVIEJO	BT-29	180	CUSHING	C-1	233	HEMINGWAY
BD-96	124	GRAEFE	BD-349	114	BROWN	BT-33	184	LANGENBECK	C-2	233	HEMINGWAY
BD-97	125		BD-351	135		BT-34	184	LANGENBECK	C-3	233	HEMINGWAY
BD-98	125		BD-352	135		BT-35	184	LANGENBECK	C-4	233	HEMINGWAY
BD-99	125		BD-353	135		BT-36	184	LANGENBECK	C-11	317	
BD-104	128		BD-354	135		BT-38	178		C-12	317	
BD-109	128		BD-355	135		BT-39	178		C-13	317	
BD-110	128		BD-356	135		BT-40	178		C-30	317	
BD-111	128		BD-360	113		BT-41	178		C-34	317	
BD-130	130	DESMARRES	BD-361	113		BT-42	178		C-35	317	
BD-131	130	DESMARRES	BD-362	113		BT-43	184	LANGENBECK	C-36	317	
BD-133	128		BD-363	113		BT-44	178		C-41	317	
BD-134	128		BD-364	113		BT-45	178		C-42	317	
BD-135	133	GRAEFE	BD-365	113		BT-46	178		C-43	317	
BD-137	128		BD-366	113		BT-48	180	SENN-GREEN	C-71	316	
BD-141	131	ADSON-BROWN	BD-367	113		BT-49	180	SENN-GREEN	C-72	316	
BD-142	126		BD-370	132	ADSON	BT-50	178		C-73	316	
BD-143	126		BD-371	132	ADSON	BT-51	178		C-74	316	
BD-144	128		BD-372	133	ADSON	BT-52	178		CD-1	276	
BD-145	125		BD-373	133	ADSON	BT-54	178		CD-2	276	
BD-148	125		BD-377	133	ADSON	BT-55	178		CD-3	276	
BD-158	138		BD-378	133	ADSON	BT-56	178		CD-4	276	
BD-159	138		BD-379	133	ADSON	BT-60	184	LANGENBECK	CH-1	70	CHOMPRET
BD-160	122	DE BAKEY	BD-380	131	ADSON	BT-62	184	LANGENBECK	CH-2	70	CHOMPRET
BD-160T	118	DE BAKEY	BD-381	131	ADSON	BT-64	184	LANGENBECK	CH-3	70	CHOMPRET
BD-161	122	DE BAKEY	BD-382	131		BT-66	184	LANGENBECK	CH-4	70	CHOMPRET
BD-165	122		BEIN-1T	51	BEIN	BT-67	187	OBWEGESER	CH-11	70	CHOMPRET
BD-175	138	RUSSIAN	BEIN-1Z	57	BEIN	BT-68	187	OBWEGESER	CH-12	70	CHOMPRET
BD-177	122	ADSON	BEIN-2	51	BEIN	BT-69	194	WASSMUND	CH-13	70	CHOMPRET
BD-178	122	ADSON	BEIN-2Z	57	BEIN	BT-70	179	DESMARRES	CH-14	70	CHOMPRET
BD-194	124	GRAEFE	BEIN-3	51	BEIN	BT-72	179		CO-1	54	COUPLAND
BD-195	124	GRAEFE	BEIN-4	51	BEIN	BT-74	179		CO-2	54	COUPLAND
BD-196	124	GRAEFE	BEIN-4Z	57	LINDO-LEVIEN	BT-77	179	DESMARRES	CO-3	54	COUPLAND





CODE	PP.	ID	CODE	PP.	ID	CODE	PP.	ID	CODE	PP.	ID
CO-11	54	COUPLAND	DF-03/9	312		DL-60	318	UNIVERSAL	DO-184	202	EPKER
CO-12	54	COUPLAND	DF-03/10	312		DL-61	62		DO-185	202	EPKER
CO-13	54	COUPLAND	DF-03/11	312		DL-62	62		DO-186	202	EPKER
COL-1/2	261	LANGER	DF-03/12	312		DL-63	62		DO-196	200	
COL-2RL	261	COLUMBIA	DF-03/13	312		DL-64	64	WINTER	DO-204	184	
COL-3/4	261	LANGER	DF-04	312	NYSTRÖM	DL-65	64	WINTER	DO-204L	184	
COL-4RL	261	COLUMBIA	DF-05/5	312		DL-66	64	WINTER	DO-212	184	AUSTIN
COL-13/14	261	COLUMBIA	DF-05/6	312		DL-67	64	WINTER	DP-24	315	
COLLEGE	120	COLLEGE	DF-05/7	312		DL-68	62		DP-24C	315	
COLLEGE-S	120	COLLEGE	DF-06	312	IVORY	DL-69	62		DP-24R	315	
CS-01	214		DF-07	312	TOFFLEMIRE	DL-73	61	BERNARD	DP-28	315	BÖHM
CS-02	214		DF-08	312	IVORY	DL-74	61	BERNARD	DP-29	315	BÖHM
CS-03	214		DF-09	312	IVORY	DL-75	61	BERNARD	DP-38	315	FURRER
CS-04	214		DF-10	309	BREWSTER	DL-76	49		DP-38A	315	KERLING
CS-05	214		DF-12	310	IVORY	DL-77	49		DP-38R	315	
CS-06	214		DF-15	309	PALMER	DL-78	49		DP-90	109	
CU-1/2	261	GRACEY	DF-16	309	STOKE	DL-79	49		DP-91	109	BEEBE
CU-3/4	261	GRACEY	DF-18	309		DL-81	44		DP-92	109	BEEBE
CU-5/6	261	GRACEY	DF-30	311		DL-82	44		DP-101	109	BEEBE
CU-7/8	261	GRACEY	DF-32	311		DL-83	44		DP-102	109	BEEBE
CU-9/10	261	GRACEY	DF-40	310	IVORY	DL-84	44		DP-103	109	BEEBE
CU-11/12	261	GRACEY	DF-40/1	310		DL-85	44		DP-104	109	BEEBE
CU-13/14	261	GRACEY	DF-40/2	310		DL-86	44		DP-105	109	BEEBE
CU-MC1	231	MILLER-COLBURN	DF-40/3	310		DL-87	44		DP-120	107	
CV-11	276		DF-41	310	IVORY	DL-88	62		DP-136	318	
DA-01	40		DF-41/4	310		DL-89	62		DP-137	318	
DA-01M	40		DF-41/5	310		DL-90	65	LECLUSE	DR-40	39,169	PEET
DA-02	40		DF-41/6	310		DL-91	45		DR-50	39	STIEGLITZ
DA-03	40		DF-43	310	IVORY	DL-92	45		DR-60	39	STIEGLITZ
DA-04	121		DF-126	311	IVORY	DL-93	45		DR-70	39	STIEGLITZ
DA-05	121		DF-127	311	IVORY	DL-94	45		DR-78	138	MILLER
DA-06	138		DF-128	311	IVORY	DL-95	45		DR-80	138	MILLER
DA-07	138	CORN	DF-129	311	IVORY	DL-96	45		E-0	284	
DA-08	138		DF-130	311	IVORY	DL-97	45		E-1	284	
DA-09	121		DF-131	311	IVORY	DL-98	60	POTT	E-2	284	
DA-10	40		DF-151	311	IVORY	DL-99	60	POTT	E-3	284	
DA-11	121		DF-160	311	IVORY	DL-100	63	WINTER	E-4	284	
DB-01	123	CRANE-CAPLAN	DK-26	38	WITZEL	DL-101	63	WINTER	EC-1	284	
DB-02	123	CRANE-CAPLAN	DK-28	38	WITZEL	DL-102	46		EC-2	284	
DB-07	322		DL-0	318		DL-103	46		EN-M1	228	
DB-08	322		DL-1	53	KRALLENHEBER	DL-104	46		EN-M2	228	
DB-1L	322	CLEANLACT	DL-2	53	KRALLENHEBER	DL-105	46		EN-M3	228	
DB-3	322	INDIA	DL-05	58	FAHRENKRUG	DL-106	43		EN-M4	228	
DB-4	322	ARKANSAS	DL-06	58	FAHRENKRUG	DL-107	43		EN-M5	228	
DB-6A	322		DL-11	56	HYLIN	DL-108	65	BARRY	EN-M6	228	
DB-10M	322	CLEANLACT	DL-13	56	HYLIN	DL-109	65	BARRY	EN-M7	228	
DB-11	322		DL-14	56	HYLIN	DL-110	65		ES-13	204	
DB-12	322		DL-17	56	HYLIN	DL-111	65		ES-27	229	
DB-15	322		DL-18	56	HYLIN	DL-112	46		ES-44	130	KÜHNE
DB-50M	322	CLEANLACT	DL-19	56	HYLIN	DL-113	46		ES-65	130	BARRAQUER
DB-71	322	CERAMIC	DL-20	48	WARWICK-JAMES	DL-114	46		EX-11	252	WILLIAMS
DB-96	322	ARKANSAS	DL-21	48	WARWICK-JAMES	DL-115	46		EX-12	252	WILLIAMS
DB-177	246	CITELLI	DL-22	48	WARWICK-JAMES	DL-116	43		F-2/3	276	
DB-178	246	CITELLI	DL-24	60	POTT	DL-117	43		FD-06	84	
DB-179	246	CITELLI	DL-25	60	POTT	DL-118	43		FD-08	84	
DB-180	246	CITELLI	DL-27	53	CRYER	DL-123	61	BERNARD	FD-10	83	NOYES
DB-181	246	CITELLI	DL-28	53	CRYER	DL-124	61	BERNARD	FD-12	83	NOYES
DB-182	246	CITELLI	DL-30	57	KOPP	DL-190	58		FD-13	83	WESTCOTT
DB-183	246	CITELLI	DL-31	57	KOPP	DL-191	58		FD-14	141	
DB-299	322	ARKANSAS	DL-32	53	CRYER	DL-C	318		FD-15	83	
DB-300	219		DL-33	53	CRYER	DL-V	318		FD-16	141	
DB-941	322		DL-34	50	APEXO	DO-1	238	HOWARD	FD-17	141	CASTROVIEJO
DB-OL	322	OIL	DL-34S	50	APEXO	DO-2	238	HOWARD	FD-18	144	CASTROVIEJO
DEAN	94	DEAN	DL-35	50	APEXO	DO-3	238	HOWARD	FD-19	141	CASTROVIEJO
DEAN-TC	102	DEAN	DL-36	50	APEXO	DO-4	238	HOWARD	FD-20	144	CASTROVIEJO
DF-00	308	IVORY	DL-37	50	APEXO	DO-4C	238	HOWARD	FD-21	146	CASTROVIEJO
DF-00L	308		DL-38	50	APEXO	DO-5	238	HOWARD	FD-22	144	CASTROVIEJO
DF-00M	308		DL-42	43	BEIN	DO-08	186	WIEDER	FD-22A	144	CASTROVIEJO
DF-00N	308		DL-43	43	BEIN	DO-09	186	WIEDER	FD-23	146	CASTROVIEJO
DF-00P	308		DL-44	43	BEIN	DO-40	186	WIEDER	FD-24	142	BARRAQUER
DF-00R	308		DL-45	43		DO-41	192	OBWEGESER	FD-25	145	JACOBSON
DF-00V	308		DL-46	43		DO-59	223	OBWEGESER	FD-26	141	
DF-01/5	312		DL-47	43		DO-63	223	OBWEGESER	FD-28	144	CASTROVIEJO
DF-01/6	312		DL-48	59		DO-65	223	OBWEGESER	FD-29	145	JACOBSON
DF-01/7	312		DL-48S	59		DO-67	223	OBWEGESER	FD-30	145	JACOBSON
DF-02	308	AINSWORTH	DL-49	59		DO-140	202	COTTLE	FD-31	143	CASTROVIEJO
DF-02M	308		DL-49S	59		DO-141	202	COTTLE	FD-32	145	JACOBSON
DF-02P	308		DL-50	234		DO-142	192	OBWEGESER	FD-33	146	DIETRICH
DF-02R	308		DL-51	234		DO-143	202	COTTLE	FD-34	143	CASTROVIEJO
DF-03/1	312		DL-52	234		DO-175	184	BOWLED-HENRY	FD-35	146	DIETRICH
DF-03/2	312		DL-54	59		DO-180	202	EPKER	FD-36	143	CASTROVIEJO
DF-03/3	312		DL-55	59		DO-181	202	EPKER	FD-37	143	CASTROVIEJO
DF-03/7	312		DL-58	48	ROSIN	DO-182	202	EPKER	FD-38	141	STEVENS
DF-03/8	312		DL-59	62		DO-183	202	EPKER	FD-41	83	



# Alphanumeric Codes

CODE	PP.	ID	CODE	PP.	ID	CODE	PP.	ID	CODE	PP.	ID
FD-42	83		FG-112	86	COTTLE-KNAPP	FL-01	203		FL-185	201	PARTSCH
FD-64	83	WESTCOTT	FG-113	86	COTTLE-KNAPP	FL-03	201	PARTSCH	FL-186	201	PARTSCH
FD-65	83	WESTCOTT	FG-121	91	KILNER	FL-04	201	PARTSCH	FL-187	201	PARTSCH
FD-137	83		FG-123	87	JAMESON-WERBER	FL-05	201	PARTSCH	FL-188	201	PARTSCH
FD-138	83		FG-124	87	JAMESON	FL-09	203	MEAD	FL-189	201	PARTSCH
FD-145	84		FG-147	89	JOSEPH	FL-09R	203	MEAD	FL-230	202	LEXER
FD-170	145		FG-148	89	JOSEPH	FL-10M	203	LUCAE	FL-231	202	LEXER
FD-171	145		FG-153	106	JOSEPH	FL-11	203	MEAD	FL-232	202	LEXER
FD-172	143		FG-154	106	JOSEPH	FL-11R	203	MEAD	FL-263	199	LAMBOT
FD-173	143	CASTROVIEJO	FG-156	87		FL-12	203	MEAD	FL-264	199	LAMBOT
FD-182	84		FG-157	87		FL-12R	203	MEAD	FL-265	199	LAMBOT
FD-183	84		FG-158	87		FL-13	201	PARTSCH	FL-266	199	LAMBOT
FD-216	142	BARRAQUER	FG-159	87		FL-14	201	PARTSCH	FL-267	199	LAMBOT
FD-217	142	BARRAQUER	FG-160	107	SMITH	FL-15	201	PARTSCH	FL-268	199	LAMBOT
FD-224	84		FG-161	107	SMITH	FL-16	199	LAMBOT	FL-269	199	LAMBOT
FD-225	84		FG-167	101	SMITH	FL-17	199	LAMBOT	FL-292	209	
FD-236	142	BARRAQUER	FG-168	101		FL-18	199	LAMBOT	FL-293	209	
FD-237	142	BARRAQUER	FG-190	91	GOLDMAN-FOX	FL-20	216		FL-294	209	
FD-562T	147		FG-191	91	GOLDMAN-FOX	FL-21	216		FL-295	209	
FD-563T	147		FG-207	85		FL-25	212		FL-296	209	
FD-574T	147		FG-208	85		FL-26	212		FL-297	209	
FD-575T	147		FG-209	85	STEVENS	FL-27	212		FL-298	209	
FD-587T	147		FG-210	85	STEVENS	FL-28	212		FL-299	209	
FD-588T	147		FG-211	85	WALTON	FL-31	216		FL-389	207	
FD-599	146		FG-212	85	WALTON	FL-32	199	LAMBOT	FL-390	207	
FD-600	146		FG-216	85	STITCH	FL-33	216		FL-391	207	
FD-601	146		FK-1	92	KELLY	FL-35	216		FL-392	207	
FD-602	146		FK-15C	102	KELLY	FL-37	212		FL-393	207	
FD-730	148	CASTROVIEJO	FK-1TC	102	KELLY	FL-38	212		FL-394	207	
FD-731	148	CASTROVIEJO	FK-2	92	KELLY	FL-39	212		FL-395	207	
FE-1	273	FELT	FK-25C	102	KELLY	FL-53	199	LAMBOT	FL-396	207	
FE-2	273	FELT	FK-2TC	102	KELLY	FL-54	199	LAMBOT	FL-397	207	
FE-3	273	FELT	FK-60	236	VOLKMANN	FL-58	199	LAMBOT	FL-398	207	
FE-4	273	FELT	FK-61	236	VOLKMANN	FL-59	202	LEXER	FL-399	207	
FE-4/5	273	FELT	FK-62	236	VOLKMANN	FL-60	202	LEXER	FL-411	202	
FE-5	273	FELT	FK-63	236	VOLKMANN	FL-61	202	LEXER	FL-412	202	
FE-6	273	FELT	FK-64	236	VOLKMANN	FL-65	211		FL-413	202	TESSIER
FG-1	86	IRIS	FK-65	236	VOLKMANN	FL-66	211		FL-414	202	TESSIER
FG-15C	104	IRIS	FK-66	236	VOLKMANN	FL-67	211		FL-415	202	TESSIER
FG-15CZ	104	IRIS	FK-67	236	VOLKMANN	FL-68	211		FL-416	202	TESSIER
FG-1TC	101	IRIS	FK-70	235	MARTINI	FL-69	211		FLAGG	120	FLAGG
FG-2	86	IRIS	FK-71	235	MARTINI	FL-70	211		FLOHR-1	52	FLOHR
FG-25C	104	IRIS	FK-72	235	VOLKMANN	FL-71	211		FLOHR-2	52	FLOHR
FG-25CZ	104	IRIS	FK-73	235	VOLKMANN	FL-72	211		FLOHR-3	52	FLOHR
FG-2TC	101	IRIS	FK-75	235	JACOBSON	FL-73	211		FM-1	98	METZENBAUM
FG-3	87		FK-76	235	MARTINI	FL-74	211		FM-1F	98	METZENBAUM
FG-4	86		FK-77	235	JANSEN	FL-75	211		FM-15C	104	METZENBAUM
FG-5	86		FK-78	235	BARTH	FL-76	211		FM-2	98	METZENBAUM
FG-11L	86	IRIS	FK-83	234		FL-77	211		FM-2F	98	METZENBAUM
FG-12L	86	IRIS	FK-84	234	JANSEN	FL-78	211		FM-25C	104	METZENBAUM
FG-13	88	IRIS	FK-87	92	KELLY	FL-79	211		FM-3	99	METZENBAUM
FG-14	89	METZENBAUM	FK-88	92	KELLY	FL-80	211		FM-3F	99	METZENBAUM-FINO
FG-15	88		FK-100	205		FL-104	203	COTTLE	FM-35C	104	METZENBAUM
FG-19C	93	KILNER	FK-101	205		FL-114	200		FM-4	99	METZENBAUM
FG-19R	93	KILNER	FK-102	205		FL-115	200		FM-4F	99	METZENBAUM-FINO
FG-20	94	NEUMANN	FK-103	205		FL-116	200		FM-45C	104	METZENBAUM
FG-21	90		FK-104	205		FL-120	208		FM-5	96	MAYO
FG-22	90		FK-105	205		FL-121	208		FM-55C	104	MAYO
FG-23	88		FK-106	205		FL-122	208		FM-6	96	MAYO
FG-24	88		FK-107	205		FL-123	208		FM-65C	104	
FG-28	89	METZENBAUM	FK-108	205		FL-124	208		FM-7	96	
FG-36	90		FK-109	205		FL-125	208		FM-8	96	
FG-37	90		FK-110	236	BRUNS	FL-128	203	HAJEK	FM-9	96	
FG-38	95	QUINBY	FK-111	236	BRUNS	FL-132	200		FM-10	96	
FG-39	95	CHADWICK	FK-112	236	BRUNS	FL-135	200		FM-12	89	METZENBAUM
FG-50	93	STEVENS	FK-113	236	BRUNS	FL-136	200		FM-27	96	
FG-51	93	STEVENS	FK-114	236	BRUNS	FL-141	210		FM-28	96	
FG-52	93	STEVENS	FK-115	236	BRUNS	FL-142	210		FM-41	96	
FG-53	93	STEVENS	FK-116	236	BRUNS	FL-143	210		FM-42	96	
FG-54	93	REYNOLDS	FK-120	236	SCHEDÉ	FL-144	210		FM-47	98	METZENBAUM
FG-55	93	REYNOLDS	FK-121	236	SCHEDÉ	FL-150	213	KEYES	FM-48	98	METZENBAUM
FG-58	87	KILNER	FK-122	236	SCHEDÉ	FL-151	213	KEYES	FM-49	96	
FG-59	86	COTTLE	FK-123	236	SCHEDÉ	FL-152	213	KEYES	FM-49	96	
FG-60	98	TOENNIS-ADSON	FK-124	236	SCHEDÉ	FL-153	213	KEYES	FM-51	107	
FG-61	98	TOENNIS-ADSON	FK-125	236	SCHEDÉ	FL-155	213	KEYES	FM-59	107	
FG-66	93	KILNER	FK-126	236	SCHEDÉ	FL-155	213	KEYES	FM-63	96	
FG-67	93	KILNER	FK-126	236	SCHEDÉ	FL-156	213	KEYES	FM-66	99	METZENBAUM
FG-92	106	PECK-JOSEPH	FK-136	234	KERPEL	FL-157	213	KEYES	FM-67	99	METZENBAUM
FG-98	106		FK-137	234	KERPEL	FL-158	213	KEYES	FM-68	99	METZENBAUM
FG-101	90		FK-138	234	KERPEL	FL-159	213	KEYES	FM-68	99	METZENBAUM
FG-102	90		FK-139	234	KERPEL	FL-177	201	PARTSCH	FM-69	99	METZENBAUM
FG-103	88		FK-188	234	UFFENORDE	FL-179	201	PARTSCH	FM-79	95	MAYO-LEXER
FG-104	88		FK-189	234	UFFENORDE	FL-181	201	PARTSCH	FM-96	100	METZENBAUM-FINO
FG-105	88		FK-197	234	WILLIGER	FL-183	201	PARTSCH	FM-97	100	METZENBAUM-FINO
			FK-198	234	WILLIGER	FL-184	201	PARTSCH	FM-98	100	METZENBAUM-FINO
									FM-99	100	METZENBAUM-FINO



# Alphanumeric Codes

CODE	PP.	ID	CODE	PP.	ID	CODE	PP.	ID	CODE	PP.	ID
FM-100	103	IRIS	G-26	258		I-133L	23		LB-23	78	
FM-100L	103	IRIS	G-28	258		I-133R	23		LB-40	75	
FM-102	103	METZENBAUM	G-30	258		I-333S	23		LB-361	75	
FM-104	103	METZENBAUM	GA-17	215		I-401	38		LB-362	75	
FM-109	89	METZENBAUM	GA-18	215		IM-15	214		LB-363	75	
FM-118	101	METZENBAUM	GA-19	215		KE-20	196		LB-364	75	
FM-119	101	METZENBAUM	GA-20	215		KE-40	196		LB-365	75	
FM-126	89	METZENBAUM	GA-33	213		KKD-1	287	KIRKLAND	LB-366	75	
FM-127	89	METZENBAUM	GA-34	213		KKD-2	287	KIRKLAND	LB-367	75	
FM-146	107		GA-35	213		KKD-4	287	KIRKLAND	LB-368	75	
FM-180	95	LEXER	GA-36	213		KN-55	200	KRAMER-NEVINS	LB-369	75	
FM-181	95	LEXER	GA-37	213		KN-75	200	KRAMER-NEVINS	LG-1	94	LA GRANGE
FM-201	100	METZENBAUM-FINO	GA-60	213		KO-1	224	KÖNIG	LG-15C	105	LA GRANGE
FM-202	100	METZENBAUM-FINO	GA-63	213		KO-2	224	KÖNIG	LG-25C	105	LA GRANGE
FM-203	100	METZENBAUM-FINO	GA-64	213		KO-3	224	KÖNIG	LG-6	94	LA GRANGE
FM-204	100	METZENBAUM-FINO	GA-65	213		KO-11	227	KILIAN	LK-1	90	LOCKLIN
FM-298	97	METZENBAUM	GA-66	213		KO-20	229	BABBUSH	LK-2	92	LOCKLIN
FM-299	97	METZENBAUM	GA-70	216		KO-22	224	SELDIN	LK-3	90	LOCKLIN
FM-300	97	STEVENS	GA-71	217		KO-23	224	SELDIN	LK-4	92	LOCKLIN
FM-301	97	STEVENS	GA-73	217		KO-58	226	BENNETT	LK-10	102	
FM-317	101	GREENBERG-PAR	GA-78	217		KO-66	227	ROGER	LK-12	102	
FM-318	97	METZENBAUM	GA-79	217		L-0	72		LS-08	218	
FM-319	97	METZENBAUM	GA-80	217		L-1	72		LS-09	218	
FM-339	106	GREGORY	GA-81	217		L-2	72		LX-50	240	ILIC
FM-350	101	KILNER	GA-85	217		L-3	72		LX-52	240	
FO-08	242	BLUMENTHAL	GA-86	217		L-4	72		LX-60	240	CHOEN
FO-09	242	BLUMENTHAL	GA-90	217		L-5	72		LX-113	220	WOLFF
FO-15	242	FRIEDMANN	GA-91	217		L-6	72		MA-1	257	
FO-16	244	FRIEDMANN	GB-2	78		L-7	72		MA-1A	257	
FO-17	242	FRIEDMANN	GB-4	76		L-8	72		MA-2	257	
FO-18	243	LUER	GF-133	214		L-9	72		MA-2A	257	
FO-19	242	BLUMENTHAL	GF-134	214		L-11	72		MA-3	257	
FO-20	244	BEYER	GF-200	320		L-21	72		MA-6	258	
FO-21	242	MEAD	GFC	91	GOLDMAN-FOX	L-22	72		MA-7	257	
FO-22	241	FRIEDMANN	GFC-S	91	GOLDMAN-FOX	L-23	72		MA-7A	257	
FO-23	241	FRIEDMANN	GFC-SC	105	GOLDMAN-FOX	L-24	72		MA-8	71	
FO-24	241	FRIEDMANN	GFC-SZ	91	GOLDMAN-FOX	L-25	72		MA-9	71	
FO-25	243	LEMPERT	GFC-TC	106	GOLDMAN-FOX	L-26	72		MA-9R	71	
FO-26	245	GARDNER	GFR	91	GOLDMAN-FOX	L-27	72		MA-11	75	
FO-33	246		GFR-S	91	GOLDMAN-FOX	L-28	72		MA-B1	77	
FO-34	244	ZAUFAL-JANSEN	GFR-SC	105	GOLDMAN-FOX	L-29	72		MA-B2	77	
FO-43	243	LEMPERT	GFR-TC	106	GOLDMAN-FOX	L-51	71		MA-B3	77	
FO-60	245	BÖHLER	GFS	94	GOLDMAN-FOX	L-52	71		MA-B3M	77	
FO-61	245	BÖHLER	GFS-SC	105	GOLDMAN-FOX	L-53	71		MA-B4	78	
FO-77	245	GARDNER	GM-01	215		L-54	71		MA-B7	77	
FO-85	241	FRIEDMANN	GM-02	215		L-55	71		MA-B7K	77	
FO-87	241	STELLBRINK	GO-1	273	GOLDSTEIN	L-56	71		MA-B8	77	
FO-88	241	STELLBRINK	GO-2	273	GOLDSTEIN	L-57	71		MA-B9	77	
FO-89	241	STELLBRINK	GO-3	273	GOLDSTEIN	L-58	71		MA-B16	76	
FO-130	220	DINGMANN	GO-4	273	GOLDSTEIN	L-59	71		MC-11	71	
FO-131	220	DINGMANN	GS-16	78		L-60	71		MC-12	71	
FO-131S	220	DINGMANN	GS-18	78		L-71	71		MC-13	71	
FO-138	244	RUSKIN	GS-26	109		L-72	71		MC-70	71	
FO-139	244	RUSKIN	H-1	275		L-73	71		MD-1	35	MEAD
FO-156	244	KLEINERT-KUTZ	H-2	275		LA-1	66		MD-2	35	MEAD
FO-157	244	KLEINERT-KUTZ	H-3	275		LA-2	66		MD-3	35	MEAD
FO-159	220	RADOLF	HB	229		LA-3	66		MD-4	35	MEAD
FO-162	246	KERRISON	HE-1	47	HEIDBRINK	LA-4	66		MEAD	223	MEAD
FO-163	246	KERRISON	HE-2	47	HEIDBRINK	LA-5	66		MERIAM	120	MERIAM
FO-165	246	KERRISON	HE-2S	47	HEIDBRINK	LA-6	66		MF-101	129	GERALD
FO-216	242	MEAD	HE-3	47	HEIDBRINK	LA-7	67		MF-101T	118	GERALD
FO-220	241	FRIEDMANN	HE-3S	47	HEIDBRINK	LA-8	67		MF-102	129	GERALD
FO-221	242	FRIEDMANN	HF-3/7	267	HIRSCHFELD	LA-9	67		MF-102T	118	GERALD
FO-229	243	LEMPERT	HF-5/11	267	HIRSCHFELD	LA-10	67		MF-103	129	GERALD
FO-230	243	LEMPERT	HF-9/10	267	HIRSCHFELD	LA-11	68		MF-104	129	GERALD
FO-231	245	CLEVELAND	HP-6	58		LA-12	68		MF-105	129	GERALD
FO-232	245	CLEVELAND	HP-7	58	COGSWELL	LA-13	68		MF-106	136	GERALD
FO-233	245	CLEVELAND	I-13	19		LA-16	68		MF-107	136	GERALD
FO-234	245	CLEVELAND	I-221/2L	22		LA-17	68		MF-110	115	
FR-16	204	FREER	I-221/2R	22		LA-20	69		MF-111	115	
FR-17	204	FREER-YASARGIL	I-22	19		LA-21	69		MF-112	115	
FREER	204,226	FREER	I-36	18		LA-22	69		MF-113	115	
G-3	257		I-36N	18		LA-23	69		MF-114	115	
G-4	257		I-46L	21		LB-10	77		MF-115	115	
G-5	257		I-46LX	21		LB-11	77		MF-124	119	
G-8	258		I-46N	20		LB-12	77		MF-125	119	
G-10	258		I-59	19		LB-12D	77		MF-126	119	
G-12	258		I-73	19		LB-13	77		MF-127	119	
G-14	258		I-74	18		LB-15	77		MF-128	119	
G-16	258		I-74N	18		LB-15A	77		MF-129	119	
G-18	258		I-79	20		LB-15C	77		MF-142T	119	
G-20	258		I-79N	20		LB-18	78		MF-143T	119	
G-22	258		I-86C	19		LB-20	78		MF-144T	119	
G-24	258		I-87	20		LB-21	78		MF-145T	119	



# Alphanumeric Codes

CODE	PP.	ID	CODE	PP.	ID	CODE	PP.	ID	CODE	PP.	ID
MF-146T	119		0-2	277		OR-18	218	CASTROVIEJO	P-233	173	CRILE
MF-147T	119		0-3	277		OR-19	218	CASTROVIEJO	P-238	173	HALSTED
MF-177	114	BISHOP-HARMON	0-4	277		OR-20	218		P-239	173	HALSTED
MF-249	114	BISHOP-HARMON	0A-1	279		OR-45	218		P-240	173	HALSTED
MF-370	116		0A-2	279		OS-1	280	WESTCOTT	P-241	173	HALSTED
MF-371	116		0A-3	279		OS-2	280	WESTCOTT	P-250	171	PEAN
MF-372	116		OBN-1	287	ORBAN	OSB-1	286	OCHSENBEIN	P-251	171	PEAN
MF-373	116		OBN-2	287	ORBAN	OSB-2	286	OCHSENBEIN	P-252	171	PEAN
MF-374	116		OBN-4	287	ORBAN	OSB-4	285	OCHSENBEIN	P-253	171	PEAN
MF-375	116		OC-1	278		OSB-4A	285	OCHSENBEIN	P-256	171	PEAN
MF-376	116		OC-2	278		OT-1	271	FELT	P-257	171	PEAN
MF-377	116		OF-1	285	FEDI	OT-2	271	FELT	P-260	171	KOCHER
MF-378	117		OF-2	285	FEDI	OT-3	271	FELT	P-261	171	KOCHER
MF-379	117		OF-3	285	FEDI	OT-4	271	FELT	P-264	168	HARTMANN-MOSQ.
MF-380	117		OK-1	277		OT-5	271	FELT	P-265	168	HARTMANN-MOSQ.
MF-381	117		OK-2	277		OT-6	271	FELT	P-266	168	JACOBSON
MF-382	117		OK-3	277		OT-7	271	GOLDSTEIN	P-267	168	JACOBSON
MF-383	117		OL-1	278		OT-8	271	GOLDSTEIN	P-324	174	JUDD-ALLIS
MF-384	117		OL-2	278		OT-9	271	GOLDSTEIN	P-332	168	DANDY-MOSQUITO
MF-385	117		OL-3	278		OT-10	271	GOLDSTEIN	P-340	219	
MI-10	55	MILLER-APEXO	OM-2	280		OT-11	272		P-341	219	
MI-11	55	MILLER-APEXO	OM-04	195	BRUENINGS	OT-12	272		P-342	219	
MI-12	55	MILLER-APEXO	OM-06	186		OT-13	272		PEB-1	37	
MI-13	55	MILLER-APEXO	OM-07	195		OT-14	272		PEB-2	37	
MIR-08	229	SURGICAL WOODSON	OM-08	186	TOBOLD	OT-15	272		PEB-3	37	
MIR-09	71		OM-10	195	COLLIN	OT-16	272		PEB-4	37	
MIR-10	236	COLLEGE	OM-16	195	KROENIG	OX-1	280		PEB-5	37	
MIR-20	54		OM-18	195	BUCHWALD	OX-2	280		PEB-6	37	
MIR-21	54		OM-19	195	FRENZEL	OX-3	280		PEB-7	37	
MIR-22	54		OM-30	195	COLLIN	OZ-1	278		PEB-17S	36	
MIR-23	54		OM-40	188	MOLT-DOYEN-COLLIN	OZ-2	278		PEB-23S	36	
MIR-24	54		OM-40R	188	MOLT-DOYEN-COLLIN	OZ-3	278		PEB-150S	36	
MIR-25	54		OM-41	188	MOLT-DOYEN-JANSEN	P-0	258		PEB-151S	36	
MIR-26	54		OM-41R	188	MOLT-DOYEN-JANSEN	P-00	258		PF-6	214,256	LUNIATSCHEK
MIR-30	206		OM-42	188	MOLT	P-000	258		PF-9	268	LANGE
MIR-31	206		OM-44	195		P-01	258		PF-40	256	UNIVERSAL
MIR-32	206		OM-45	195	YOUNG	P-02	258		PF-41	256	UNIVERSAL
MIR-33	206		OM-50	191	STERNBERG	P-03	258		PH-37	149	HALSEY
MO-2	237	MOLT	OM-52	191	STERNBERG	P-3	257		PH-38	149	
MO-4	237	MOLT	OM-55	191	MINNESOTA	P-04	258		PH-39	149	DERF
MO-4L	237	MOLT	OM-55B	191	MINNESOTA	P-4	257		PH-40	159	MAYO-HEGAR
MO-4LT	237	MOLT	OM-60	188	ROSER-KÖNIG	P-05	258		PH-41	159	MAYO-HEGAR
MO-4RT	237	MOLT	OM-61	191	BISHOP	P-5	257		PH-42	159	MAYO-HEGAR
MO-8	229	MOLT	OM-62	188	HEISTER	P-06	258		PH-48	149	HALSEY
MO-9A	226	MOLT	OM-66	191	CAWOOD-MINNESOTA	P-15	169		PH-53	153	
MO-10	231,237	MOLT	OM-66B	191	CAWOOD-MINNESOTA	P-49	172	KOCHER	PH-54	156	CRILE-WOOD
MO-12	231	MOLT	OM-67	191	STERNBERG	P-50	174	ALLIS	PH-58	155	
MO-15	225	MOLT	OM-70	196		P-52	174	ALLIS	PH-59	155	HEGAR
MO-20	227	MOLT	OM-71	196		P-61	173	LERICHE	PH-60	316	
MO-24	227	MENEHINI	OM-72	196		P-62	173	LERICHE	PH-61	149	CRILE-WOOD
MOLT-9	226	MOLT	OM-74	189	ORINGER	P-63	173	LERICHE	PH-62	149	CRILE-MURRAY
MPI-1	214		OM-75	189		P-64	173	LERICHE	PH-63	149	HALSEY
MRT/C7	316		OM-76	189		P-79	172	KOCHER	PH-64	149	
MRT-6	316		OM-77	189	ORINGER	P-81	172		PH-65	153	
MRT-7	316		OM-80	185		P-82	172	CRILE	PH-66	153	WEBSTER
MRT-C1	317		OM-81	185		P-84	172	KELLY	PH-67	153	HALSEY
MRT-C3	317		OM-82	185		P-85	172	KELLY	PH-68	153	CONVERSE
MRT-C4	317		OM-85	185		P-86	172	CRILE	PH-69	153	DERF
NK-1	76		OM-87	185		P-87	172	CRILE	PH-70	159	MAYO-HEGAR
NK-2	76		OM-88	185		P-89	172	KOCHER	PH-71	156	CRILE-WOOD
NK-3	76		OM-90	189		P-91	170	HALSTED	PH-72	155	HEGAR
NK-06	79	ZIEGLER	OM-97	189	MATY	P-92	170	HALSTED	PH-73	153	HALSEY
NK-07	79	LA FORCE	OM-100	185		P-93	170	HALSTED	PH-74	159	MAYO-HEGAR
NK-08	79	GRAEFE	OM-110	193	DINGMANN	P-94	170	HALSTED	PH-75	155	HEGAR
NK-09	79	ELLIS	OM-112	193	DINGMANN	P-95	170	HALSTED-MOSQUITO	PH-76	155	HEGAR
NK-10	79	ZIEGLER	OM-113	193	DINGMANN	P-96	170	HALSTED-MOSQUITO	PH-77	155	CRILE-WOOD
NK-11	79		OM-114	193	DINGMANN	P-97	170	HALSTED-MOSQUITO	PH-79	152	CRILE-WOOD
NK-12	75		OM-136	193	DINGMANN	P-98	170	HALSTED-MOSQUITO	PH-80	151	RYDER
NK-14	79	GRAEFE	OM-137	193	DINGMANN	P-100	174	ALLIS	PH-81	151	RYDER
NK-16	79	GRAEFE	OM-138	193	DINGMANN	P-101	169	HALSTED	PH-82	151	RYDER
NK-17	79		OM-139	193	DINGMANN	P-102	169	HALSTED	PH-83	151	RYDER
NK-18	79	GRAEFE	ON-1	280		P-115	174	ALLIS	PH-84	151	RYDER
NK-20	79	GRAEFE	OP-1	279		P-120	168	HARTMANN-MOSQ.	PH-85	152	SWEDISH
NK-30	80		OP-2	279		P-121	168	HARTMANN-MOSQ.	PH-90	156	CRILE-WOOD
NK-32	80		OP-3	279		P-129	174	BOYS-ALLIS	PH-99	156	
NK-34	80		OP-4	279		P-135	169	HALSTED	PH-100	156	CRILE-WOOD
NK-36	80		OP-5	279		P-136	171	MIXTER	PH-101	154	MICRO VASCULAR
NK-38	80		OP-6	216		P-137	171	MIXTER	PH-102	154	MICRO VASCULAR
NK-39	79		OP-7	216		P-215	171		PH-103	154	MICRO VASCULAR
NK-40	80		OP-8	216		P-216	171		PH-106	152	SWEDISH
NK-105	204		OR-11	218	CASTROVIEJO	P-217	171		PH-110	154	DE BAKEY
NK-249	204	SAUTTER	OR-12	218	CASTROVIEJO	P-230	173	CRILE	PH-111	154	DE BAKEY
NK-251	204	MODELL-GIESSEN	OR-13	218	CASTROVIEJO	P-231	173	CRILE	PH-120	154	HEGAR
O-1	277		OR-14	218	CASTROVIEJO	P-232	173	CRILE	PH-121	154	HEGAR



CODE	PP.	ID	CODE	PP.	ID	CODE	PP.	ID	CODE	PP.	ID
PH-122	154	HEGAR	S-51B	16		SS-42	270		USG-13/14	263	GRACEY
PH-127	154	MAYO-HEGAR-FINO	S-51LX	17		SS-50	269		USG-13/14ET	262	GRACEY
PH-128	154	MAYO-HEGAR-FINO	S-66L	14		SS-51	269		USG-13/14L	264	GRACEY
PH-129	154	MAYO-HEGAR-FINO	S-66R	14		SS-52	269		USG-13/14S	263	GRACEY
PH-132	155	SAROT	S-67L	15		SS-54	269		USG-15/16	264	GRACEY
PH-133	155	SAROT	S-67N	15		SS-55	269		USG-15/16ET	262	GRACEY
PH-134	155	SAROT	S-67R	15		SS-56	269		USG-17/18S	264	GRACEY
PH-140	146	RYDER	S-80	16	FELSCH	SS-58	269		USG-KN1/26	264	KRAMER-NEVINS
PH-141	146	RYDER	S-97	16		SS-60M	215		USS-5/6LAN	264	LANGER
PH-142	146	RYDER	S-97B	16		SS-61M	215		USS-5/33	265	JACQUETTE
PL-1	254	LUKS	S-351S	17		SS-62M	215		USS-15/30	265	TOWNER-JACQUETTE
PL-2	254	LUKS	S-400	38		SS-64M	215		USS-15/33	265	TOWNER-JACQUETTE
PL-3	254	LUKS	SC-1	108	SPENCER	SS-65	214,270		USS-204S	265	
PL-4	254	LUKS	SC-2	108	SPENCER	STF-1	260		USS-H6/7	265	
PM-1	282		SC-5	108	SPENCER	STF-1R	260		USS-J14/15	265	JACQUETTE
PM-2	282		SC-9	108	SPENCER	TASO-1	230	TASO	USS-KRA1	264	KRAMER
PM-3	282		SC-13	108	SPENCER	TASO-2	230	TASO	USS-KRA3	264	KRAMER
PM-4	282		SC-14	108	SPENCER	TASO-3	230	TASO	USS-MC11/12	264	McCALL
PM-5	282		SC-15	108	LITTAUER	TASO-4	230	TASO	USS-MC13/14	264	McCALL
PM-6	282		SC-16	108	KELLY	TASO-5	230	TASO	USS-MC13/14S	264	McCALL
PO-37	159	CRILE	SD-1	260		TASO-6	230	TASO	USS-MC17/18S	264	McCALL
PO-38	159	TÖNNIS	SD-2	260		TASO-7	130	TASO	USS-NV0	265	NEVI
PO-40	160		SD-3	260		TASO-8	230	TASO	USS-NV11/12	265	NEVI
PO-45	161	MATHIEU	SD-3R	260		TASO-9	130	TASO	USS-NV13/14	265	NEVI
PO-46	160	MATHIEU	SD-7	259		TG-10	199	FREER	USS-T2/3	265	TAYLOR
PO-47	160	MATHIEU	SD-7R	259		TG-11	199	FREER	USS-YG7/8	206	YOUNGER-GOOD
PO-48	160	MATHIEU	SD-8	259		TG-12	199	FREER	UST-1/2MS	206	ORBAN
PO-50	158	MATHIEU	SD-8M	259		TG-15	200		UST-1/2ML	206	ORBAN
PO-51	158		SD-8NA	259		TG-20	199	FREER	UST-KPA	206	
PO-52	158	MATHIEU	SD-8W	259		TG-21	199	FREER	UST-MP	206	
PO-55	158	BOYNTON	SD-8WM	259		TG-22	199	FREER	UST-MPA	206	
PO-56	158	BOYNTON	SD-9NA	259		TG-23	199	FREER	WEST	223	WEST
PO-59	150	GILLIES	SD-88	259		TG-20	200		WG-10	223	WILLIGER
PO-60	161	MATHIEU	SD-88M	259		TG-31	200		WG-12	223	WILLIGER
PO-61	161	MATHIEU	SD-20	259		TG-32	200		WG-14	223	WILLIGER
PO-65	160	MATHIEU	SD-20M	259		TS-1	283	BLACK			
PO-68	161	SMAHA	SD-M	72		TS-2	283	BLACK			
PO-69	161	SMAHA	SE-2	58	SELDIN	TS-3	283	BLACK			
PO-71	161	MATHIEU	SE-4L	58	SELDIN	TS-4	283	BLACK			
PO-76	161	SMAHA	SE-4R	58	SELDIN	TS-40	214				
PO-77	161	SMAHA	SL-1	231		TT-01	118	COLLEGE			
PO-78	160	MATHIEU	SL-2	231		T-USG-1/2	266	GRACEY			
PO-79	160	MATHIEU	SL-21	233		T-USG-5/6	266	GRACEY			
PO-80	160	MATHIEU	SM-1	253	WILLIAMS	T-USG-7/8	266	GRACEY			
PO-81	160	MATHIEU	SM-2	253	MERRIT	T-USG-11/12	266	GRACEY			
PO-82	158	MATHIEU	SM-3	253	MERRIT	T-USG-13/14	266	GRACEY			
PO-84	158	MATHIEU	SM-4	253	GOLDMAN-FOX	T-USS-YG7/8	266	YOUNGER-GOOD			
PO-85	158	ARRUGA	SM-5	253	UNIV. MICHIGAN	T-USS-B5/6	266	BARNHART			
PO-86	158	LICHTENBERG	SM-6	253		USB-P2	216				
PO-87	158	ARRUGA	SM-11	251		USB-P3	216				
PO-88	158	BOYNTON	SM-12	251		USB-P4	216				
PO-94	158	BOYNTON	SM-13	251		USB-P1	216				
PO-99	157	GILLIES	SM-15	251		USB-P3Z	216				
PO-99L	157	GILLIES	SM-19	251		USB-P1Z	216				
PO-104	157	FOSTER-GILLIES	SM-20	252	CATTONI	USB-P2Z	216				
PO-105	157	FOSTER-GILLIES	SM-21	251	WHO	USB-P4Z	216				
PR-3	226	PRICHARD	SM-22	252	NABERS	USC-2	276	COLUMBIA			
PR-3A	226	PRICHARD	SO-1	249		USC-2RL	264	COLUMBIA			
PZ-1	254		SO-2	249		USC-4RL	264	COLUMBIA			
PZ-2	254		SO-3	249		USC-13/14	264	COLUMBIA			
PZ-3	254		SO-4	249		USG-1/2	263	GRACEY			
PZ-4	254		SO-5	249		USG-1/2ET	262	GRACEY			
R-1	275	HOLLENBACH	SO-6	249		USG-1/2L	264	GRACEY			
R-2	275	HOLLENBACH	SO-7	250		USG-1/2S	263	GRACEY			
R-3	275	HOLLENBACH	SO-8	250		USG-3/4	263	GRACEY			
RH-4	257		SO-9	250		USG-3/4ET	262	GRACEY			
RH-4A	257		SO-10	250		USG-3/4L	264	GRACEY			
RH-5	257		SO-11	250		USG-3/4S	263	GRACEY			
RH-5A	257		SO-12	250		USG-5/6	263	GRACEY			
RH-14	257		SO-20	252		USG-5/6ET	262	GRACEY			
RH-15A	257		SP-1	255		USG-5/6L	264	GRACEY			
RO-1	39		SP-2	255		USG-5/6S	263	GRACEY			
S-0	274		SP-3	255		USG-7/8	263	GRACEY			
S-00	274		SP-4	255		USG-7/8ET	262	GRACEY			
S-1	274		SP-5	255		USG-7/8L	264	GRACEY			
S-2	274		SP-6	255		USG-7/8S	263	GRACEY			
S-3	274		SP-7	255		USG-9/10	263	GRACEY			
S-3AN	13		SR	274		USG-9/10ET	262	GRACEY			
S-4	274		SS-15	270		USG-9/10L	264	GRACEY			
S-7	13		SS-16	270		USG-9/10S	263	GRACEY			
S-31	14		SS-20	216		USG-11/12	263	GRACEY			
S-34	13		SS-21	216		USG-11/12ET	262	GRACEY			
S-35	13		SS-22	216		USG-11/12L	264	GRACEY			
S-49	17		SS-41	270		USG-11/12S	263	GRACEY			



Manufacturer of high quality  
hand-held surgical instruments for  
**General Surgery | Dental**

 [Ehsansurgical.com](https://Ehsansurgical.com)



## EHSAN SURGICAL

POSWAL STREET, PASRUR  
ROAD  
SIALKOT 51310, PAKISTAN

+92 52 3543475  
+92 52 3543479

[info@ehsansurgical.com](mailto:info@ehsansurgical.com)

 [Ehsansurgical.com](http://Ehsansurgical.com)